

ES CON



FALL PROTECTION SOLUTIONS





RIGID LIFELINES[®]

What's New? 5

Our Products

Full Body Harnesses 6

Self-Retracting Lanyards 12

Shock Absorbing Lanyards 19

Roofer's Kit 26

Accessories 27

Engineered Track Systems 32

Rooftop Systems - XSPlatforms 54

Elevated Worksite Analysis 78

Warranty & Service Policy 80

Why Rigid Lifelines? 83

Customer Testimonials 84

Laws & Codes 86

How to Buy 87



WHAT'S NEW AT RIGID LIFELINES®?

Most people know Rigid Lifelines as a company that provides high quality fall protection systems, but now, we're excited to expand our offering to include an all new line of quality products including harnesses, shock absorbing lanyards, self-retracting lanyards and several anchor connectors, to name a few. As part of our vision to become a full solutions provider, Rigid Lifelines will continue to develop and introduce high quality, user friendly products into the market at a cost effective price.

Evolve™ Harnesses are available in six different styles and include standard features such as 5 points of adjustment, dual lanyard keepers, and fall indicators. Evolve deluxe harnesses feature extra padding, removable tool belt, and quick-connect chest and leg buckles.

Defy™ Self-Retracting Lanyards include lightweight, high impact polymer housings available with either galvanized cable or polyester webbing in lengths ranging between 6' and 50'. All units include an installation carabiner for connecting to a suitable anchor and load load-indicating swivel locking snap hooks for attaching to the harness dorsal D-Ring.

Connex™ Shock Absorbing Lanyards are available in various designs, all with standard features such as 3,600 lbs. rated gates and Polyester webbing for UV and abrasion resistance. Different connector options are available to meet the needs of the application.

RFID Technology is included on every Evolve Full Body Harness, Defy Self-Retracting Lanyard, and Connex Shock Absorbing Lanyard. This technology makes it easy to keep track of where equipment is located and when it was last inspected. RFID is also faster to accurately record precise equipment data. Thanks to cloud technology, your equipment information is always accessible in a secure database.

With the **Gravity Guard™** Roofer's Kit, people doing residential construction work can have access to a complete fall protection system that fits inside a 5-gallon bucket. Gravity Guard has everything needed for working at height, including a full body harness, re-usable roof anchor, rope grab assembly, and 5/8" rope lifeline.

We hope that you find everything you need to maximize the effectiveness of your fall protection systems. If you can't find what you're looking for, let us know. You can send us an email at sales@rigidlifelines.com or give us a call at **800-869-2080** and one of our technical sales specialists will help you.

FITS LIKE A GLOVE. HOLDS LIKE A FIST.



Padded Dorsal
D-Ring And
Shoulder Assembly

D-Rings Have
A Protective
Roller To Reduce
Web Abrasion

Dual Fall Tab
Indicators

Removable Tool Belt

Dual Lanyard Keepers
For Stowing Unused
Leg(s) Of Connectors

Quick-Connect Buckles
(Chest and Legs)

4" Comfort Padding
With D-Rings For
Work Positioning



Take your fall protection to the next level with the **Evolve™ Full Body Harness**. All of our harnesses come standard with 5 points of adjustment for a superior fit and maximized comfort, dual lanyard keepers to store lanyards when not in use, dual fall indicators for faster inspection, and plastic roller wear pads that reduce wear on the webbing material. Our harnesses are made with high quality, durable materials that take worker comfort into consideration.

Product #: RL-15502GB

* For all of the same features above, but with quick-connect leg straps, order product: RL-15502DB



Product #: RL-15502D



Evolve™ Deluxe Universal Fit Full Body Harness
 (Single Back D-Ring, 2 Side D-Ring Work Positioning Comfort Back Pad with Removable Tool Belt, Shoulder Padding, Dual Lanyard Keepers, Dual Fall Indicators, Quick-Connect Buckle Chest, Tongue Buckle Legs)
Product #: RL-15502GB

- Product Information:**
- Made up of high tenacity polyester webbing - greater than 5,000 lbs. break strength
 - 1 dorsal D-Ring for fall arrest, 2 side D-Rings for Work Positioning
 - 5 point adjustability (chest, legs, and torso)
 - Grommeted Leg straps with Tongue Buckle adjustment
 - Quick-connect chest strap for ease of adjustability
 - 2 Lanyard Keepers for proper stowing of idle lanyard connector(s)
 - Dual Fall Indicators on shoulder straps
 - Meets ANSI Z359.1-2007



Evolve™ Deluxe Universal Fit Full Body Harness
 (Single Back D-Ring, 2 Side D-Ring Work Positioning Comfort Back Pad with Removable Tool Belt, Shoulder Padding, Dual Lanyard Keepers, Dual Fall Indicators, Quick-Connect Buckles Chest and Legs)
Product #: RL-15502DB

- Product Information:**
- Made up of high tenacity polyester webbing - greater than 5,000 lbs. break strength
 - 1 dorsal D-Ring for fall arrest, 2 side D-Rings for Work Postioning
 - 5 point adjustability (chest, legs, and torso)
 - Quick-connect leg and chest straps for ease of adjustability
 - 2 Lanyard Keepers for proper stowing of idle lanyard connector(s)
 - Dual Fall Indicators on shoulder straps
 - Meets ANSI Z359.1-2007



Evolve™ Universal Fit Full Body Harness (Single Back D-Ring, Dual Lanyard Keepers, Dual Fall Indicators, Mating Buckle Legs)
Product #: RL-15502D

- Product Information:**
- Made up of high tenacity polyester webbing - greater than 5,000 lbs. break strength
 - 1 dorsal D-Ring for fall arrest
 - 5 point adjustability (chest, legs, and torso)
 - Pass Thru Mating Buckle leg and chest straps for ease of adjustability
 - 2 Lanyard Keepers for proper stowing of idle lanyard connector(s)
 - Dual Fall Indicators on shoulder straps
 - Meets ANSI Z359.1-2007



Product #: RL-15502G
Evolve™ Universal Fit Full Body Harness (Single Back D-Ring, Dual Lanyard Keepers, Dual Fall Indicators, Tongue Buckle Legs)

Product Information:

- Made up of high tenacity polyester webbing - greater than 5,000 lbs. break strength
- 1 dorsal D-Ring for fall arrest
- 5 point adjustability (chest, legs, and torso)
- Grommeted Leg straps with Tongue Buckle adjustment
- Pass Thru Mating Buckle chest strap for ease of adjustability
- 2 Lanyard Keepers for proper stowing of idle lanyard connector(s)
- Dual Fall Indicators on shoulder straps
- Meets ANSI Z359.1-2007



Product #: RL-15503D
Evolve™ Universal Fit Full Body Harness (Single Back D-Ring, 2 Side D-Rings, Dual Lanyard Keepers, Dual Fall Indicators, Mating Buckle Legs)

Product Information:

- Made up of high tenacity polyester webbing - greater than 5,000 lbs. break strength
- 1 dorsal D-Ring for fall arrest, 2 side D-Rings for Work Positioning
- 5 point adjustability (chest, legs, and torso)
- Pass Thru Mating Buckle leg and chest straps for ease of adjustability
- 2 Lanyard Keepers for proper stowing of idle lanyard connector(s)
- Dual Fall Indicators on shoulder straps
- Meets ANSI Z359.1-2007



Product #: RL-15503G
Evolve™ Universal Fit Full Body Harness (Single Back D-Ring, 2 Side D-Rings, Dual Lanyard Keepers, Dual Fall Indicators, Tongue Buckle Legs)

Product Information:

- Made up of high tenacity polyester webbing - greater than 5,000 lbs. break strength
- 1 dorsal D-Ring for fall arrest, 2 side D-Rings for Work Positioning
- Grommeted Leg straps with Tongue Buckle adjustment
- 5 point adjustability (chest, legs, and torso)
- Pass Thru Mating Buckle chest strap for ease of adjustability
- 2 Lanyard Keepers for proper stowing of idle lanyard connector(s)
- Dual Fall Indicators on shoulder straps
- Meets ANSI Z359.1-2007



Product #: RL-8-0161; RL-8-0184
Deluxe Women's Harness
 (Single Back D-Ring, Lanyard Keeper, 2 Fall Indicators, Mating Buckle Adjusters)

Product Information:

- Made of abrasion-resistant polyester webbing
- 5 point adjustability (chest, legs, and torso)
- Oversized tongue buckles on each leg strap
- Lanyard keeper for storage of lanyard when not in use
- Strap keepers for storing extra strap
- Dual fall indicators on shoulder straps
- Meets ANSI Z359.1-2007

Full Body Harness Selector Guide	RL-15502D	RL-15502G	RL-15503D	RL-15503G	RL-15502DB	RL-15502GB	8-0184
Use	Fall Arrest and Restraint		Fall Arrest, Restraint, and Positioning				Fall Arrest and Restraint
Working Load (User & Tools)	Up to 310 lbs.						
Material	High Tenacity Polyester Webbing						
D-Rings	Dorsal		Dorsal & Side				Dorsal
Chest Adjuster Style	Pass Thru Mating Buckle				Quick-Connect		Pass Thru Mating Buckle
Leg Strap	Mating Buckle	Grommeted Leg Straps with Tongue Buckle Adjustments	Mating Buckle	Grommeted Leg Straps with Tongue Buckle Adjustments	Quick-Connect	Grommeted Leg Straps with Tongue Buckle Adjustments	Mating Buckle
Padding	No				Yes		

Warning - Applications involving aggressive atmospheres and environments may require the use of specialized Fall Protection Harnesses. Please contact us for more information.

WE'VE GOT YOUR BACK.



Defy™ gravity with self-retracting lanyards that meet or exceed your expectations. High impact polymer housings provide durable protection of the interior workings of the SRL, while still being light enough to travel freely without dragging above a worker's head. Our self-retracting lanyards meet or exceed all OSHA and ANSI requirements to provide a superior user experience. Depending upon the needs of your facility, you can get either web strap or cable as a connecting material while still maintaining a lightweight unit.

ANSI Rated Locking Installation Carabiner



High Impact Polymer Housing

ANSI Rated Steel Swivel Snap Hook With Fall Indicator

3,600 lbs. Gate Strength

Product #: RL-PS-30FT-GALV



Product #: RL-PCWB-6FT
Defy™ Self-Retracting Lanyard
 (6' Polyester 1" Webbing, Polymer Housing, Locking Snap Hook on Cable End, Locking Installation Carabiner on Top)

- Product Information:**
- Housing - High impact strength Polymer
 - Web Material - 1" Polyester
 - Web Break Strength - 4,500 lbs.
 - Web Length - 6'
 - Working Load Capacity Rating - 310 lbs.
 - ANSI rated steel swivel snap hook on lifeline end, ANSI rated carabiner on top of unit
 - Meets ANSI Z359.14-2012 and OSHA



Product #: RL-PCGS-10FT
Defy™ Self-Retracting Lanyard
 (10' Galvanized Cable, Polymer Housing, Locking Snap Hook on Cable End, Installation Carabiner on Top)

- Product Information:**
- Housing - High impact strength Polymer
 - Cable Material - Galvanized Steel Wire Rope 3/16"
 - Cable Break Strength - 3,400 lbs.
 - Cable Length - 10'
 - Working Load Capacity Rating - 310 lbs.
 - ANSI rated steel swivel snap hook on lifeline end, ANSI rated carabiner on top of unit
 - Meets ANSI Z359.14-2012 and OSHA



Product #: RL-PCWB-11FT
Defy™ Self-Retracting Lanyard
 (11' Polyester 1" Webbing, Polymer Housing, Locking Snap Hook on Cable End, Locking Installation Carabiner on Top)

- Product Information:**
- Housing - High impact strength Polymer
 - Web Material - 1" Polyester
 - Web Break Strength - 4,500 lbs.
 - Web Length - 11'
 - Working Load Capacity Rating - 310 lbs.
 - ANSI rated steel swivel snap hook on lifeline end, ANSI rated carabiner on top of unit
 - Meets ANSI Z359.14-2012 and OSHA



Product #: RL-PW-20FT
Defy™ Self-Retracting Lanyard
 (20' Polyester 1" Webbing, Polymer Housing, Locking Snap Hook on Cable End, Locking Installation Carabiner on Top)

- Product Information:**
- Housing - High impact strength Polymer
 - Web Material - 1" Polyester
 - Web Break Strength - 4,500 lbs.
 - Web Length - 20'
 - Working Load Capacity Rating - 310 lbs.
 - ANSI rated steel swivel snap hook on lifeline end, ANSI rated carabiner on top of unit
 - Meets ANSI Z359.14-2012 and OSHA



Product #: RL-PW-40FT
Defy™ Self-Retracting Lanyard
 (40' Polyester 1" Webbing, Polymer Housing, Locking Snap Hook on Cable End, Locking Installation Carabiner on Top)

- Product Information:**
- Housing - High impact strength Polymer
 - Web Material - 1" Polyester
 - Web Break Strength - 4,500 lbs.
 - Web Length - 40'
 - Working Load Capacity Rating - 310 lbs.
 - ANSI rated steel swivel snap hook on lifeline end, ANSI rated carabiner on top of unit
 - Meets ANSI Z359.14-2012 and OSHA



Product #: RL-PS-20FT-GALV
Defy™ Self-Retracting Lanyard
 (20' Galvanized Cable, Polymer Housing, Locking Snap Hook on Cable End, Installation Carabiner on Top)

- Product Information:**
- Housing - High impact strength Polymer
 - Cable Material - Galvanized Steel Wire Rope 3/16"
 - Cable Break Strength - 3,400 lbs.
 - Cable Length - 20'
 - Working Load Capacity Rating - 310 lbs.
 - ANSI rated steel swivel snap hook on lifeline end, ANSI rated carabiner on top of unit
 - Meets ANSI Z359.14-2012 and OSHA



Product #: RL-PS-50FT-GALV

Defy™ Self-Retracting Lanyard

(50' Galvanized Cable, Polymer Housing, Locking Snap Hook on Cable End, Installation Carabiner on Top)

Product Information:

- Housing - High impact strength Polymer
- Cable Material - Galvanized Steel Wire Rope 3/16"
- Cable Break Strength - 3,400 lbs.
- Cable Length - 50'
- Working Load Capacity Rating - 310 lbs.
- ANSI rated steel swivel snap hook on lifeline end, ANSI rated carabiner on top of unit
- Meets ANSI Z359.14-2012 and OSHA



Product #: RL-4030

Metal Self-Retracting Lanyard

(30' Cable, Zinc-Plated Full Steel Case, Snap Hook with Load indicating swivels)

Product Information:

- Housing - Zinc-plated Full Steel Case
- Cable Material - Galvanized Aircraft Cable - 3/16" diameter
- Cable Length - 30'
- Working Load Capacity Rating - 400 lbs.
- Meets ANSI Z359.14-2012 and OSHA



Product #: RL-4050

Metal Self-Retracting Lanyard

(50' Cable, Zinc-Plated Full Steel Case, Snap Hook with Load indicating swivels)

Product Information:

- Housing - Zinc-plated Full Steel Case
- Cable Material - Galvanized Aircraft Cable - 3/16" diameter
- Cable Length - 50'
- Working Load Capacity Rating - 400 lbs.
- Meets ANSI Z359.14-2012 and OSHA

SRL Selector Guide	RL PCWB 6FT	RL PCGS 10FT	RL PCWB 11FT	RL-PW 20FT	RL-PW 40FT	RL-PS 20FT GALV	RL-PS 30FT GALV	RL-PS 50FT GALV	4030	4050
Lanyard Length	6'	10'	11'	20'	40'	20'	30'	50'	30'	50'
Material	Polyester Webbing (1" Diameter)	Galvanized Steel Wire Rope (3/16" Diameter)	Polyester Webbing (1" Diameter)	Polyester Webbing (1" Diameter)	Polyester Webbing (1" Diameter)	Galvanized Steel Wire Rope (3/16" Diameter)	Galvanized Steel Wire Rope (3/16" Diameter)	Galvanized Steel Wire Rope (3/16" Diameter)	Galvanized Steel Wire Rope (3/16" Diameter)	Galvanized Steel Wire Rope (3/16" Diameter)
Maximum Fall Force	900 lbs. Maximum Arresting Force (MAF)									
Housing	High Impact Strength Polymer								Zinc-Plated Full Steel Case	
Lifeline Material Break Strength	4,500 lbs.	3,400 lbs.	4,500 lbs.	4,500 lbs.	4,500 lbs.	3,400 lbs.	3,400 lbs.	3,400 lbs.	3,400 lbs.	3,400 lbs.
Unit Weight	5 lbs.	3 lbs.	5 lbs.	12 lbs.	16 lbs.	12 lbs.	13 lbs.	18 lbs.	25 lbs.	26.8 lbs.
Working Load Capacity	310 lbs.	310 lbs.	310 lbs.	310 lbs.	310 lbs.	310 lbs.	310 lbs.	310 lbs.	400 lbs.	400 lbs.

FALL ARREST MEANS FEAR ARREST.



Get a better anchorage connection with the **Connex™ Shock Absorbing Lanyard**. These lanyards come in several styles and materials to fit the needs of different work environments. Some of our shock absorbing lanyards have an internal shock absorber to make a lighter weight device that is more compact and cost effective. Other lanyards have a hard shock pack that provides an easier inspection point. And some lanyards feature a twin leg design to provide 100% tie-off during movement between anchorage points. These lanyards are especially perfect for agricultural and construction applications.



Product #: RL-3118(6)



Product #: RL-3119(6)
Connex™ 6' Clear Pack Shock Absorbing Lanyard with 1 Locking Snap Hook, 1 #18 Locking Rebar Hook

Product Information:

- Length of Lanyard - 6'
- Rated Shock Pack Absorber Free Fall Limit - 6'
- Webbing Break Strength - 6,000 lbs.
- Connectors - Steel ANSI rated locking snap hook at attachment end and one steel ANSI rated rebar hook at anchorage end
- Meets OSHA and ANSI Z359.13-2009



Product #: RL-30198(6)
Connex™ 6' Twin Leg "Y" Style 100% Tie Off Clear Pack Shock Absorbing Lanyard with 3 Locking Snap Hooks

Product Information:

- Length of Lanyard - 6'
- Rated Shock Pack Absorber Free Fall Limit - 6'
- Webbing Break Strength - 6,000 lbs.
- Connectors - Steel ANSI rated locking snap hooks at all three ends
- Meets OSHA and ANSI Z359.13-2009



Product #: RL-30199(6)
Connex™ 6' Twin Leg "Y" Style 100% Tie Off Clear Pack Shock Absorbing Lanyard with 1 Locking Snap Hook, 2 #18 Locking Rebar Hooks

Product Information:

- Length of Lanyard - 6'
- Rated Shock Pack Absorber Free Fall Limit - 6'
- Webbing Break Strength - 6,000 lbs.
- Connectors - Steel ANSI rated locking snap hook at attachment end and two steel ANSI rated rebar hooks at anchorage ends
- Meets OSHA and ANSI Z359.13-2009



Free Form Internal Energy Absorber With 900 lbs. Maximum Arresting Force With Sewn-In Fall Indicator Tabs

Tubular Polyester Outer Jacket For UV And Abrasion Resistance

ANSI Rated 3,600 lbs. Gate Strength

Additional Internal Wear Pad Protection Where Hook Meets Webbing

Product #: RL-3128(6)

Product #: RL-3129(6)
Connex™ 6' Internal Shock Absorbing Lanyard with 1 Locking Snap Hook, 1 #18 Locking Rebar Hook

Product Information:

- Length of Lanyard - 6'
- Rated Shock Pack Absorber Free Fall Limit - 6'
- Webbing Break Strength - 6,000 lbs.
- Connectors - Steel ANSI rated locking snap hook at attachment end and one steel ANSI rated rebar hook at anchorage end
- Meets OSHA and ANSI Z359.13-2009



Product #: RL-30298(6)
Connex™ 6' Twin Leg "Y" Style 100% Tie Off Internal Shock Absorbing Lanyard With 3 Locking Snap Hooks

Product Information:

- Length of Lanyard - 6'
- Rated Internal Shock Absorber Free Fall Limit - 6'
- Webbing Break Strength - 6,000 lbs.
- Connectors - Steel ANSI rated locking snap hooks at all three ends
- Meets OSHA and ANSI Z359.13-2009



Product #: RL-30299(6)
Connex™ 6' Twin Leg "Y" Style 100% Tie Off Internal Shock Absorbing Lanyard with 1 Locking Snap Hook, 2 #18 Locking Rebar Hooks

Product Information:

- Length of Lanyard - 6'
- Rated Internal Shock Absorber Free Fall Limit - 6'
- Webbing Break Strength - 6,000 lbs.
- Connectors - Steel ANSI rated locking snap hook at attachment end and one steel ANSI rated rebar hook at anchorage end
- Meets OSHA and ANSI Z359.13-2009



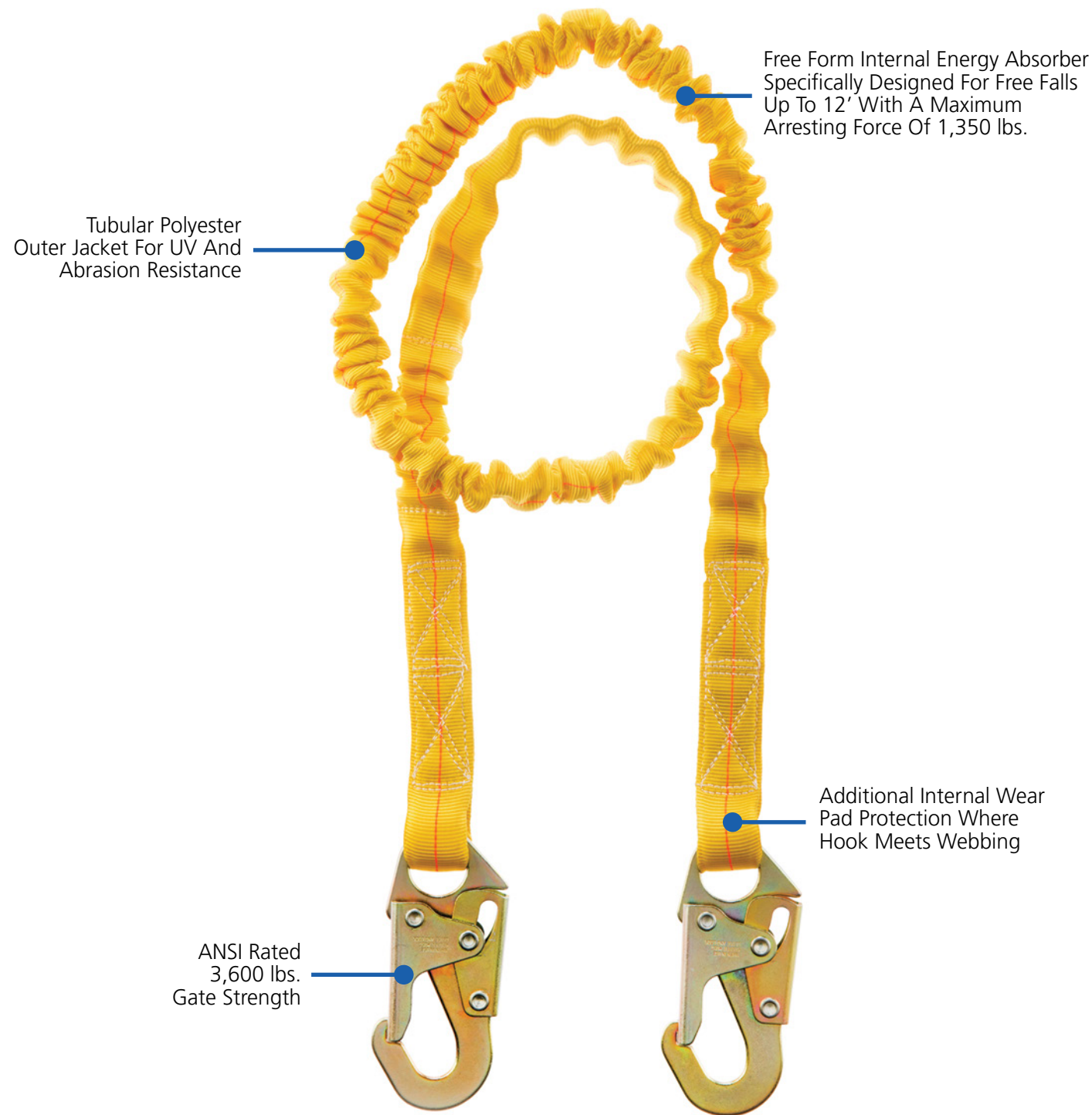

Product #: RL-30298(12)
Connex™ 6' Twin Leg "Y" Style 100% Tie Off Extended (12') Rated Free fall Internal Shock Absorbing Lanyard With 3 Locking Snap Hooks

- Product Information:**
- Length of Lanyard - 6'
 - Rated Internal Shock Absorber Free Fall Limit - 12'
 - Webbing Break Strength - 6,000 lbs.
 - Connectors - Steel ANSI rated locking snap hooks at all three ends
 - Meets OSHA and ANSI Z359.13-2009

Shock Absorbing Lanyards Selector Guide	RL-3118(6)	RL-3119(6)	RL-30198(6)	RL-30199(6)	RL-30128(6)	RL-30129(6)	RL-30298(6)	RL-30299(6)	RL-30128(12)	RL-30298(12)
Lanyard Length	6'									
Maximum Free Fall	6'	6'	6'	6'	6'	6'	6'	6'	12'	12'
Maximum Arresting Force	900 lbs. Maximum Arresting Force (MAF)								1,350 lbs. MAF	
Anchorage Connections	2 Snap	1 Snap/1 Rebar	3 Snap	1 Snap/2 Rebar	2 Snap	1 Snap/1 Rebar	3 Snap	1 Snap/2 Rebar	2 Snap	3 Snap
Style of Shock Absorber	Clear Pack	Clear Pack	Clear Pack	Clear Pack	Internal	Internal	Internal	Internal	Extended Free Fall	Extended Free Fall
Single or Twin Legged	Single		Twin		Single		Twin		Single	Twin

Product #: RL-3128(12)



GRAVITY GUARD™

Guard yourself from the dangers of gravity with the **Gravity Guard™ Roofer's Kit**. Our kit contains an Evolve™ Full Body Harness, a Connex™ Rope Grab Assembly with 50' of rope, a locking installation carabiner, a reusable roof anchor with 32 nails, and a 5 gallon bucket for storage and equipment transportation. This kit can be used during construction on residential roofs. These kits make it easy and convenient for construction workers to have access to fall protection systems while working on a rooftop.



Product #: RL-RK1 Gravity Guard Roofer's Kit

Includes:

- Evolve Full Body Harness
- 50' 5/8" Vertical Rope Lifeline w/attached 3' Connex Rope Grab Assembly
- ANSI rated locking installation carabiner on top end of vertical rope lifeline, stop-knot on bottom end
- Reuseable roof anchor with 32 nails
- 5 gallon storage bucket
- Meets OSHA and ANSI Z359.1

ROOF ANCHORS

Rigid Lifelines® offers three different types of roof anchors to meet the various needs of people working at height. A single use roof anchor is good for providing fall protection for a one day job on a roof. The reusable roof anchor accommodates a 2 or 3 day job. And the permanent roof anchor is made of durable stainless steel to provide a permanent durable fall protection anchorage on a roof that will be accessed frequently.



Product #: RL-05 Single Use Steel Roof Anchor

Product Information:

- Meets ANSI Z359.1-2007
- Material: Galvanized Steel
- Minimum Breaking Strength: 5,000 lbs./23kN
- Finish: Golden Yellow Galvanized
- Net Weight: 1 lb.



Product #: RL-01(A) Reusable Hinged Steel Roof Anchor

Product Information:

- Meets ANSI Z359.1-2007
- Material: Galvanized Steel with Forged D-Ring
- Minimum Breaking Strength: 5,000 lbs./23kN
- Finish: Powder Coated or Zinc Plated
- Net Weight: 2.44 lbs.



Product #: RL-02(A) Permanent Use Stainless Steel Roof Anchor

Product Information:

- Meets ANSI Z359.1-2007
- Material: Stainless Steel with forged D-ring on both sides
- Finish: Polished Silver/Golden Yellow Galvanized
- Net Weight: .9 lbs.

CONNECTORS

Get connected to your fall protection. We offer both steel carabiners and wire anchor forms, depending upon what type of fall protection equipment you use and how you need to connect to the rest of your system. Every Rigid Lifelines® connector meets all ANSI Z359 requirements including 3,600 lbs. rated gates where applicable. There are various connector sizes designed to meet the needs of many types of anchorage points. Each connector is exceptionally lightweight to minimize any potential drag for the user.



Product #: RL-113-A
Small Steel Carabiner - .85" Gate Opening

Product Information:

- Meets ANSI Z359.12-2009
- Minimum Break Strength: 5,000 lbs./23kN
- Gate Strength: 3,600 lbs.
- Material: Alloy Steel
- Gate Opening: .85"
- Finish: Golden Yellow Galvanized
- Net Weight: .62 lbs.
- Proof Load Tested



Product #: RL-134A
Large Steel Carabiner - 2" Gate Opening

Product Information:

- Meets ANSI Z359.12-2009
- Minimum Break Strength: 5,000 lbs./23kN
- Gate Strength: 3,600 lbs.
- Material: Alloy Steel
- Gate Opening: 2"
- Finish: Golden Yellow Galvanized
- Net Weight: 1.89 lbs.
- Proof Load Tested



Products #: RL-141, RL-142, RL-143
Wire Anchor Form Stainless Steel Gate Opening

Product Information:

- Meets ANSI Z359.1-2007
- Minimum Break Strength: 5,000 lbs./23kN
- Heavy Duty SAE 304 Stainless Steel Construction
- #141 Fits rated structural members up to 5" in diameter
- #142 Fits rated structural members up to 4" in diameter
- #143 Fits rated structural members up to 3" in diameter
- Only intended for overhead applications

ROPE GRAB

Get a grip on your rope with a Connex™ Rope Grab. Our rope grab device is designed with a 3-foot shock absorbing lanyard built into it for energy absorption during fall arrest. It also features locking snap hooks for a secure harness attachment. These are lightweight and perfect for use with rope that is 5/8" in diameter.



Product #: RL-3002
Connex Manual Rope Grab with 3' Shock Absorbing Lanyard

Product Information:

- Length of Rope Grab Assembly – 21 3/4"
- Steel Rope Grab for use with suitably rated 5/8" rope lifeline
- Shock Pack with rope grab at one end, other end with locking snap hook for attachment to harness
- Meets requirements of ANSI and OSHA

ANCHOR STRAPS

Anchor straps can be choked around suitably rated I-beams or other suitably rated structures. Typically, vertical lifelines, such as lanyards, SRL's and rope lifelines are connected to the anchor strap's D-Ring.



Product #: RL-AS3
3' Choker Style Cross Arm Anchor Strap with 2.75" Wear Pad

Product Information:

- Length of Anchor Strap - 3'
- Made up of 1.75" wide Polyester webbing stitched with 2.75" webbing wear pad on the back for extra protection
- Anchor Strap having one side with small forged D-Ring, and other side with large forged D-Ring
- PVC rollers where webbing is looped around D-Rings for added protection
- Meets OSHA and ANSI Z359.1



Product #: RL-AS4
4' Choker Style Cross Arm Anchor Strap with 2.75" Wear Pad

Product Information:

- Length of Anchor Strap - 4'
- Made up of 1.75" wide Polyester webbing stitched with 2.75" webbing wear pad on the back for extra protection
- Anchor Strap having one side with small forged D-Ring, and other side with large forged D-Ring
- PVC rollers where webbing is looped around D-Rings for added protection
- Meets OSHA and ANSI Z359.1



Product #: RL-AS6
6' Choker Style Cross Arm Anchor Strap with 2.75" Wear Pad

Product Information:

- Length of Anchor Strap - 6'
- Made up of 1.75" wide Polyester webbing stitched with 2.75" webbing wear pad on the back for extra protection
- Anchor Strap having one side with small forged D-Ring, and other side with large forged D-Ring
- PVC rollers where webbing is looped around D-Rings for added protection
- Meets OSHA and ANSI Z359.1

SUSPENSION TRAUMA RELIEF PACKS

Get a leg up on your rescue plan with suspension trauma relief straps. These slim profile pouches attach to almost any type of harness and contain a loop of web strap that workers can step onto, post fall arrest. By having something to relieve the pressure of the harness on their legs while waiting to be rescued from a fall protection system, workers will be less likely to experience suspension trauma. If a rescue will take longer than 10 minutes to occur, you may want to consider adding suspension trauma relief straps to your fall protection equipment. Suspension trauma can have devastating effects on a worker's body. But this device offers a simple and effective way to ward off the dangers of suspension trauma.



Product #: RL-TRP
Harness Suspension Trauma Relief Packs

Product Information:

- Designed to help relieve the negative effects of suspension trauma
- Compact and lightweight - does not hamper the activity of the worker while at work
- Allows the worker to stand up while suspended in their harness to relieve pressure
- Easy to attach to just about any harness
- Easy to deploy for operation



Product #: RL-8-0166-10; RL-8-0166-15; RL-8-01066-20
Extension Cables for Fall Arrest Lanyards

Lengths available: 10', 15', 20'

Product Information:

- 5,000 lbs. fall arrest load rating
- 1/4" wire rope, galvanized cable
- Zinc-plated O-Ring
- Double-action locking snap hook
- Zinc-plated, forged steel hooks
- Gate strength exceeds 3,600 lbs.
- Exceeds ANSI Z359.1-2007



Product #: RL-8-0173
Retrieval Taglines

Lengths available: 20', 25', 30'

Product Information:

- Material: 3/4" UV-Resistant Polyester Webbing
- Two stainless steel O-Rings at each end
- Custom lengths available upon request
- **WARNING:** Retrieval taglines must never be used as an anchorage; doing so could result in serious injury or death



**ENGINEERED
TRACK SYSTEMS**

TRACKS FOR FALL PROTECTION

High Performance, Low Maintenance

Rigid Lifelines® tracks are self-cleaning, so trolleys continuously roll with minimal resistance. The enclosed track also protects trolley wheels while ensuring their accurate alignment. Plus, our rigid track design saves up to 3' of headroom since – unlike wire rope systems – there is no need for a “sag allowance.”

Plain Track: PT Series

- Our lowest profile design keeps installation space requirements to a minimum
- Track can be custom-curved for specific paths

Trussed Track: R Series

- Trussed design spans greater distance between supports
- Combination of high-strength to low-weight ratio reduces stress on structures

Dual Trussed Track: DST Series

- All the advantages of the trussed design, plus dual tracks to allow two or more users to pass each other in the same work area

Triple Trussed Track: TST Series

- All the advantages of the trussed design. Tracks designed so three workers can be connected and pass one another within the protected workspace.

Quad Trussed Track: QST Series

- All the advantages of the trussed design. Track is designed so four workers can be connected and pass one another within the protected workspace.

Alu-Track® Series

- Extruded from high-strength 6061-T6 aluminum alloy
- Maintenance-free aluminum is suitable for clean rooms, refrigeration areas, and other controlled environments

Plain Track
PT Series

Trussed Track
R Series

Dual Trussed Track
DST Series

Triple Trussed Track
TST Series

Quad Trussed Track
QST Series

Alu-Track Series®

Track Options

- Alu-Track®
- Steel track: rolled from ASTM A572, A607, or A715 grade steel; available with enamel, powder, epoxy, or galvanized coatings
- Stainless steel track: 304 stainless for 500 Series track for the following systems: Traveling Bridge, Ceiling Mounted Monorails, and Swing Arms
- Mylar™ lip seal: for additional track protection from very heavy dust or paint overspray applications

Track Hardware

Flush Hanger for plain track series. Mount either parallel or perpendicular to ceiling beams.

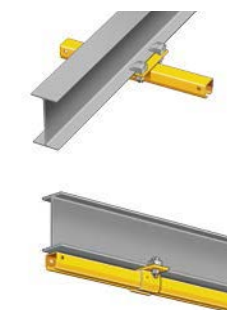

Standard Drop Hanger

for plain track series. Features support bracket, 12" drop rod, and adjustable roof beam clamp. Sway bracing required.



Trussed Track Cross Mount Hanger

allows customers to hang a truss track to their existing structural beam.



Trussed Track Drop Hanger

for trussed track series. Features support bracket, 12" drop rod, and adjustable roof beam clamp. Sway bracing required.



Mylar™ Lip Seal



Sloped Hangers with drop rods that accommodate slopes up to 14°. Call us for system applicability.



End Stop Bumper

standard on all systems. Bumper is through-bolted to track ends; resilient rubber increases impact resistance.

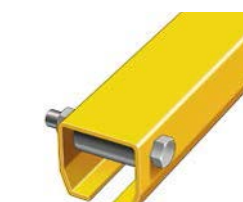

Splice for plain track series. Precisely align and connect track sections using two vertical and four horizontal adjustment screws (provided).



Trussed Track Splice

for trussed track series. Two-piece; first splice same as above. Second splice is for truss and includes four vertical adjustment screws.



ANCHOR TROLLEY

Minimizing Track Drift

The Anchor Trolley™ is our newest innovation in rolling trolley technology. The Anchor Trolley is designed with cone teeth made of hardened alloy steel that acts as a braking mechanism that engages the steel track in the event of a fall. The engagement of the trolley teeth and track causes the trolley to anchor into place without changing the track, virtually eliminating post-fall drift on the track. The Anchor Trolley greatly increases the opportunity for conscious and able-bodied workers to perform a self-rescue after a fall event. Like our other trolleys, the Anchor Trolley is made from non-consumable materials while being weather-proof and temperature-proof. This ensures that you still have the same smooth movement that has come to be associated with Rigid Lifelines® enclosed track fall arrest trolleys.

Features

- Reduces drifting on the track after a fall event
- Increases the chances for self-rescue
- Comes standard with engineered track from Rigid Lifelines

Greatly Reduces Risk of Suspension Trauma

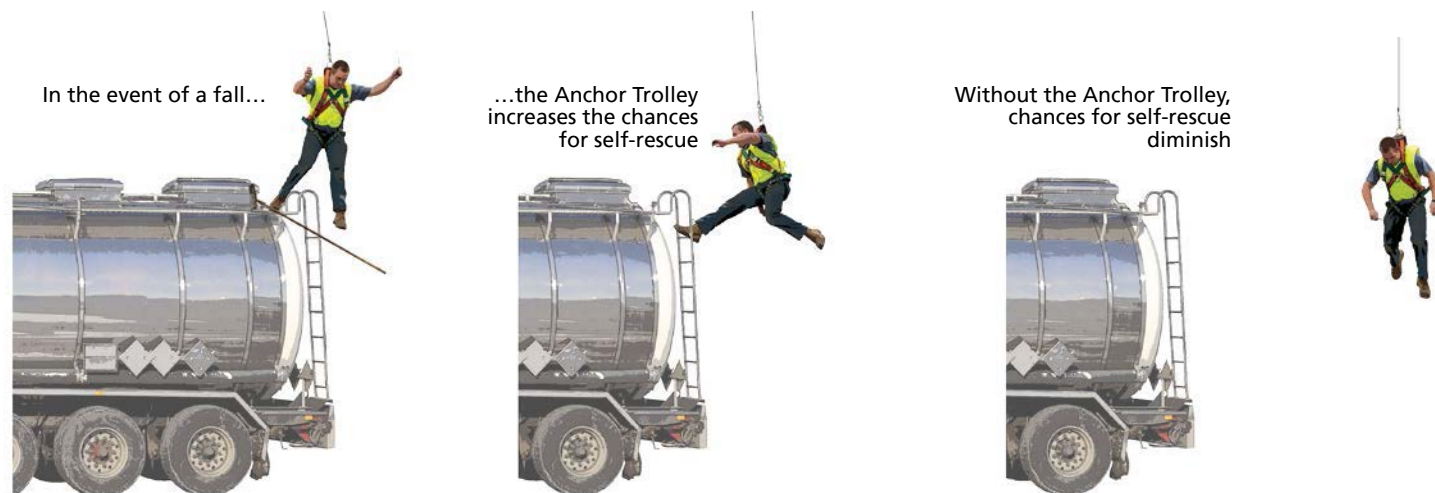

Anchor Trolley

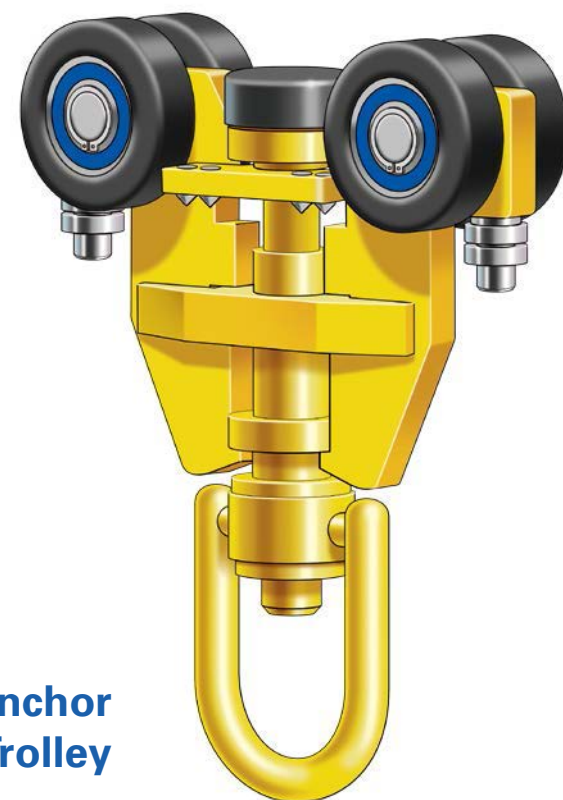

The Anchor Trolley travels inside the Rigid Lifelines track

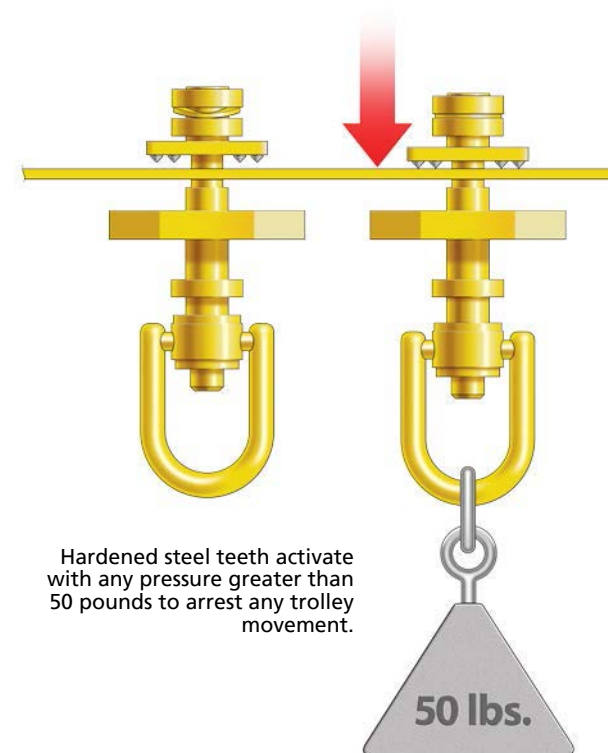

Hardened steel teeth activate with any pressure greater than 50 pounds to arrest any trolley movement.

50 lbs.

Super Responsive Trolleys

For fall arrest systems, how the trolley rolls is the difference between user frustration and enthusiastic user acceptance. Our multi-prong approach to minimum rolling resistance is:

- Enclosed tracks: protecting trolley wheels and their alignment
- Self-cleaning tracks
- Sealed bearings for trolley wheels

Rigid Lifelines trolleys readily and effortlessly follow their user. They're also super responsive. Once the user stops moving, the self-retracting lanyard brings the trolley as close as possible to the worker.

Rotating Eyebolt Eliminates Side-Loading Stress

On many of our fall protection systems, users are free to travel up to 30° off-plumb of the track. On competing systems, that sort of travel would cause side-loading stress to the trolley's eyebolt.

By comparison, the eyebolt on our Anchor Trolley rotates 360° – preventing the lanyard's strap from getting twisted. And the eyebolt also swivels 180° off-plumb to eliminate side-loading stresses. These swiveling and pivoting actions are virtually imperceptible to the user. Together, they provide maximum freedom of movement and minimal equipment wear.

TRAVELING BRIDGES

360° User Movement in Large Buildings

Rigid Lifelines® Traveling Bridge Fall Protection Systems feature a trolley that traverses a traveling bridge. The traveling bridge, in turn, glides along two mounted runways.

With the double axes, the trolley can effortlessly follow the user in any direction (360°). The worker's attachment point is always centered over their head – minimizing swing fall hazards – something not possible on wire rope or I-beam systems.

Ceiling-mounted systems are mounted either parallel or perpendicular (cross) to the building's existing ceiling support beams. Flush mount hangers maximize working heights, while a drop rod hanger with sway bracing can be used to overcome overhead obstacles.

Freestanding systems are compatible with large overhead cranes, since they only come up to the length of the freestanding columns. Freestanding systems can also be easily repositioned when workflow or plant layout changes.

Features

- Reduces drifting on the track after a fall event
- Increases the chances for self-rescue
- Comes standard with engineered track from Rigid Lifelines

Coverage Area



Application Options

- Unlimited runway lengths
- Traveling bridge widths up to 40' and beyond with custom engineered solutions
- Multiple bridges for multiple workers and/or very large work areas
- Aluminum or stainless steel construction
- Kit systems or custom-engineered systems

Design

- Runways hung over work space and bridge travels along the runways

Support Structures

- Runways are mounted to either:
- The ceiling's existing support beams, or
- Freestanding floor-bolted support columns with headers

Advantages

- User's attachment is always centered over their head, eliminating swing fall hazard
- Omni-directional, 360° user movement & protection
- User can do multiple tasks over a large area without unhooking
- Multiple bridges allow multiple workers to work independently in separate areas while attached (1 user per bridge)

Examples

- Aircraft Hangars & Factories
- Large Vehicle Maintenance Facilities
- Large Industrial & Processing Buildings

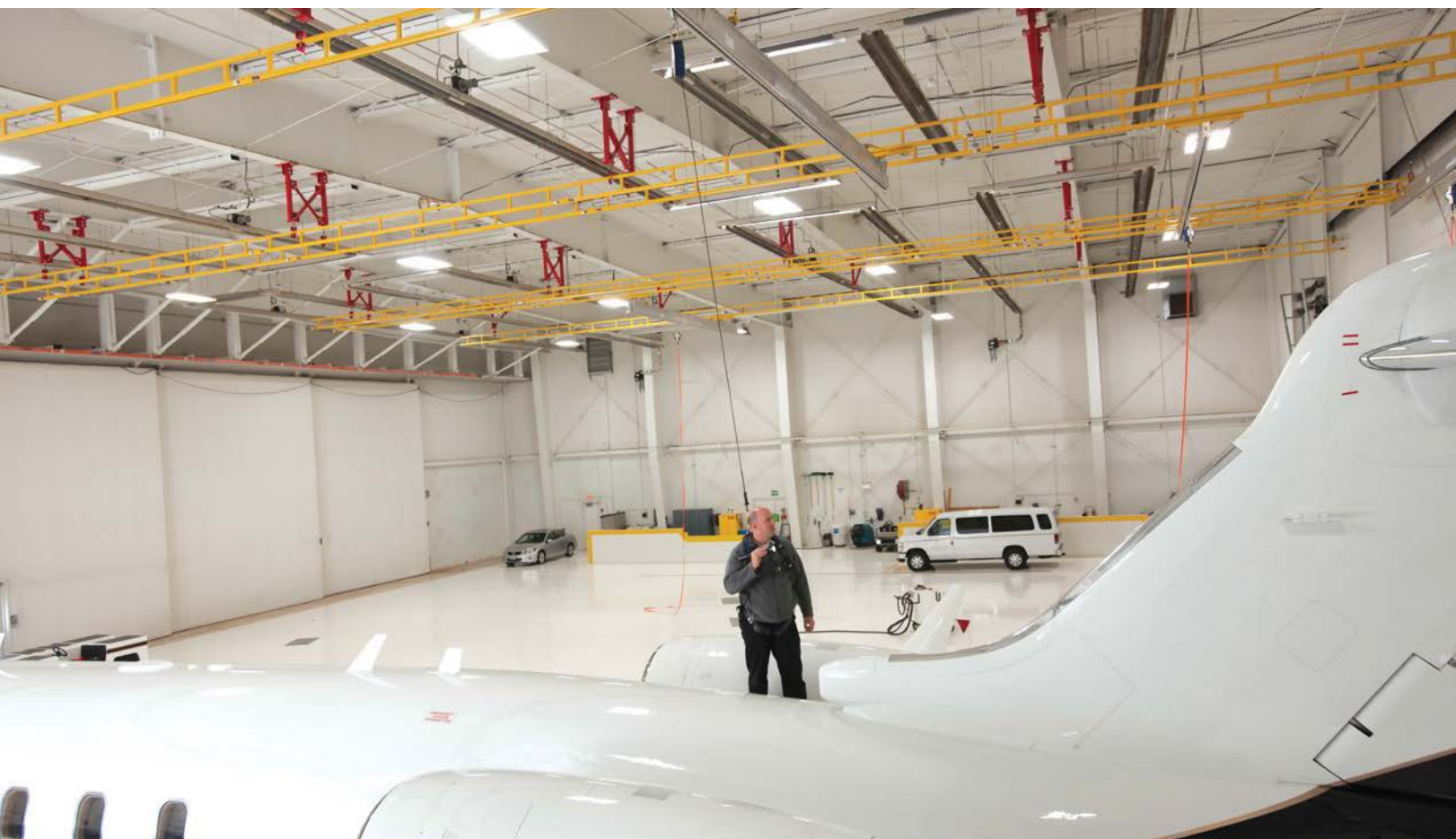

CEILING MOUNTED MONORAIL

Fall Protection Without Loss of Floor Space

Rigid Lifelines® Ceiling Mounted Monorails Fall Protection Systems easily mount to existing structures and can support long runs and curves.

Users travel the track's fixed path, but with the ability to move up to 30° off-plumb — all the while benefiting from rigid track (minimal fall distance) protection. These systems are widely used for protected worker mobility for vehicle loading/unloading, industrial cleaning, and maintenance tasks.

Our monorail systems can be readily installed in buildings with very tall ceilings. They are available:

- As individual components, or
- As complete system kits, or
- Custom-engineered to meet your specific needs

Coverage Area



Application Options

- 2-way or 3-way switches allow multiple users to move in different directions on the same track
- Single track, dual track, or multiple track systems
- Tracks can be mounted to a sloped beam up to 14° using sloped hangers with drop rods
- Stainless steel track available

Design

Trussed tracks are hung to follow worker's paths

Support Structures

Tracks are mounted either:

- Flush-mounted parallel to ceiling beams, or
- Cross-mounted to the ceiling beams, or
- Mounted with any length drop rods (requires sway bracing), including hangers for slopes up to 14°

Advantages

- Requires no floor space for support columns
- Easy installation, even in large buildings with tall ceilings
- Layout flexibility, including curves, slopes, switches, multiple tracks, etc.
- Ideal for repeated travel along fixed pathways

Examples

- Truck, Rail, Air, & Transit Facilities
- Petroleum & Coal Processing Plants
- Chemical, Plastics & Rubber Processing Facilities
- Pulp & Paper Manufacturing
- Machinery Manufacturing
- Warehousing & Storage Facilities
- Performing Arts & Entertainment Industry

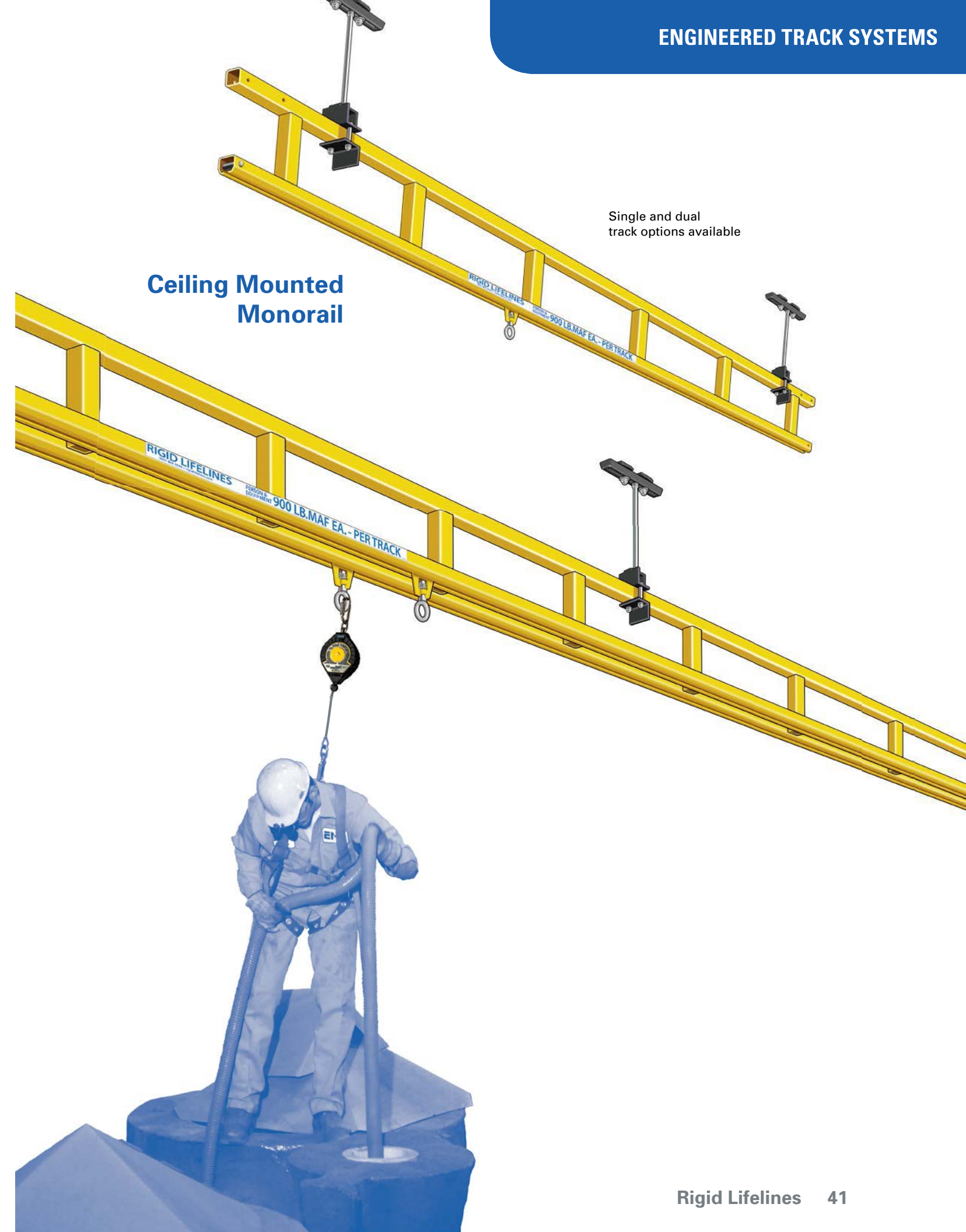

FREESTANDING MONORAIL

For Long Outdoor Paths With No Existing Structures

Rigid Lifelines® Freestanding Monorail Systems

provide permanently installed fall protection over long spans where there are no existing structures.

Inverted-L Systems

Wide flange steel columns with gusset reinforcements hold cantilevered headers from which the track(s) hangs.

- Standard height of 22' allows access to the tops of railroad cars, tank trucks, trailers, and outdoor equipment and systems
- Standard reach begins at 8'

Inverted-U Systems

Each frame consists of two columns connected by a support beam from which the monorail hangs. With two or more frames, monorail spans can be any length.

- Larger systems may require foundations, but they are smaller than the foundations required by cantilevered systems
- Heights and clear spans available per application

T-Frame Systems

Each frame consists of a foundation-mounted column topped with a beam that forms the "T".

- With two or more frames, the parallel monorails can be designed to span any length.
- Service two lines of vehicles with only one row of columns

Coverage Area



Application Options

- Single, dual, or multiple tracks for use by one, two, or multiple workers
- Custom designs for your facilities' unique demands; includes custom-sized cantilevers and/or support structures

Design

Monorails hung to follow worker's paths

Support Structures

Three different designs, each with foundation-mounted columns supporting beam-attached trussed track(s)

Advantages

Long spans of fall protection coverage in areas without existing structures

Examples

- Railcar Sidings
- Truck Loading, Securing, & Tarping
- Tank Car Loading & Servicing (e.g., water tankers)
- Agricultural Transportation
- Logging: Securing & Unloading
- Oil & Gas Extraction
- Petroleum & Coal Processing
- Manufacturing & Maintenance of Large Vehicles & Equipment

Inverted-L Freestanding Monorail

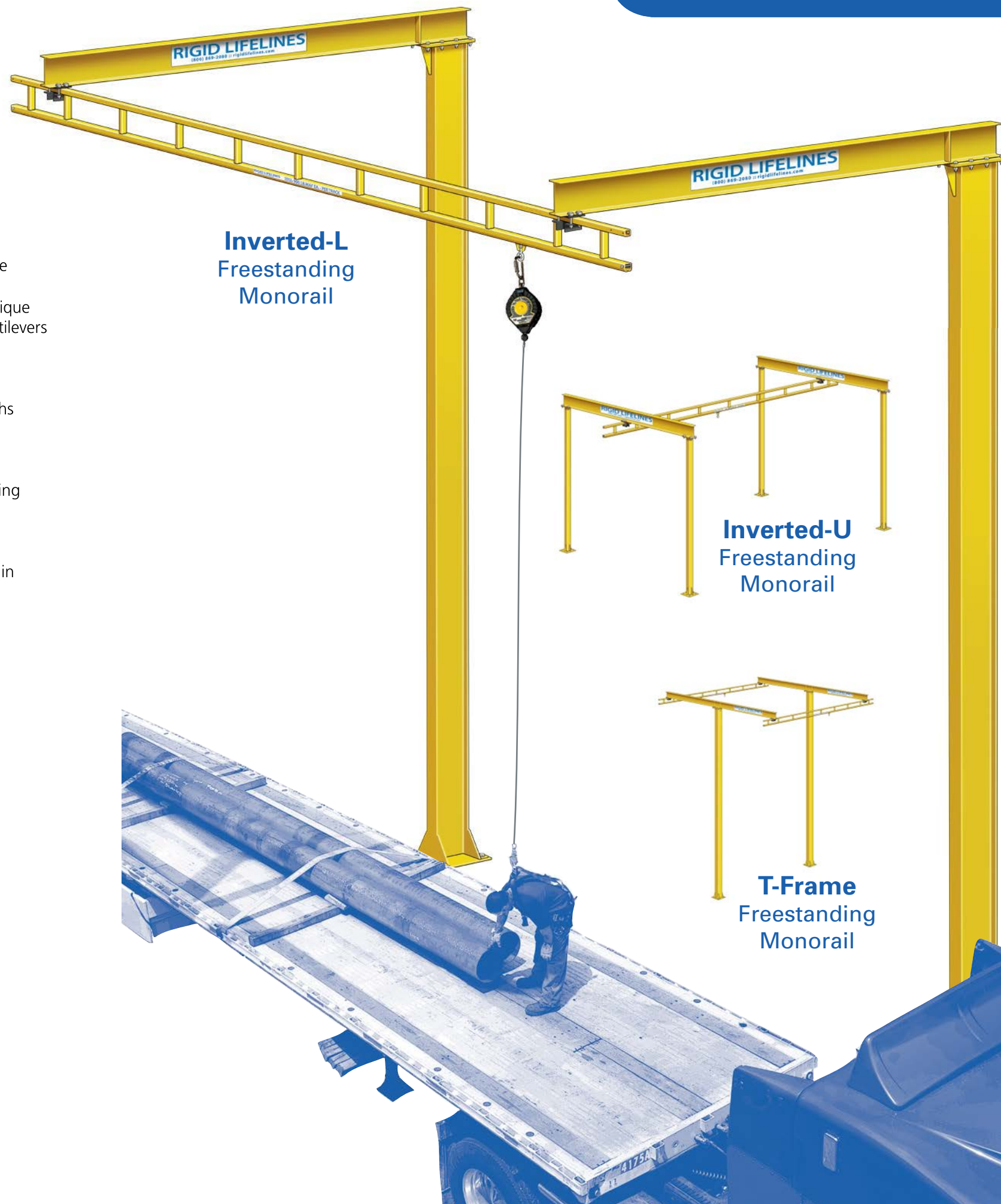

Inverted-U Freestanding Monorail

T-Frame Freestanding Monorail

THE GRIFFIN™

Mobile Fall Protection For Many Locations

The Griffin™ by Rigid Lifelines® provides rigid track fall protection with coverage of up to 30° off-plumb. With typical overall weights of approximately 15,000 lbs., the entire system can be moved in minutes using a large forklift and leveled using the provided leveling jack plates.

Quick and simple Do-It-Yourself field assembly with bolt-together components — no welding required. Frequently used in exposed outdoor locations, our enclosed track design prevents dirt or ice build-up, so the trolley effortlessly follows the user's movements as they traverse tops of vehicles and other large equipment.

- Standard lengths from 20' to 60'
- Standard reach starting at 8'
- Standard height starting at 22'

Application Options

- Single, dual, or multiple tracks for use by one, two, or multiple workers
- Optional leveling jacks (jack plates are standard)

Rolling base options:

- Non-pneumatic tires
- Steerable rolling chassis
- Tongue Bar Coupler (Class 3 or higher)
- Drawbar Eye Coupler (for Pintle hitch)
- Custom sizes & configurations available

Design

Griffin system with counterweighted base

Support Structures

Track(s) is held by cantilevered headers from 1 or 2 support columns attached to one of the following bases:

- Standard skid-mounted base, or
- Optional steerable rolling chassis base, or
- Coupler-equipped rolling chassis base

Advantages

- Excellent for temporary applications, indoors or outdoors
- Fully assembled system can be lifted with large forklift or, with the proper options, rolled or towed

Examples

- Trucks: Loading, Securing & Tarping
- Manufacturing & Maintenance of Large Vehicles & Equipment



Skidded Griffin

Coverage Area

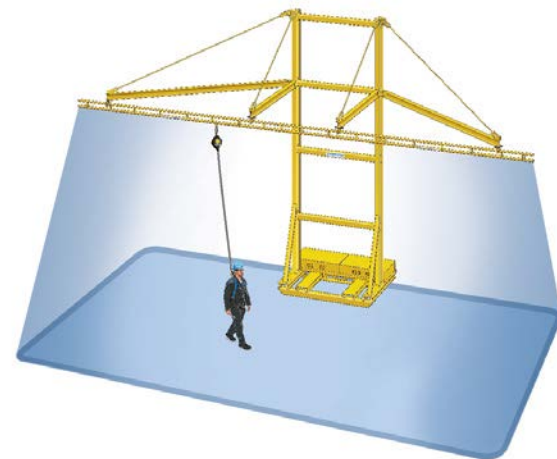

Wheel Mounted options are available



FOLD-AWAY

Compatible With Overhead Cranes & Space Restricted Work Areas

Rigid Lifelines® Fold-Away Systems are ideal for facilities needing a fall arrest system that folds up and out of the way.

When the arms are fully extended, the system provides workers with a fixed path of rigid track fall protection. Users can travel up to 30° off-plumb of the track.

When not in use, the track and its arms can be folded against their support columns (e.g., the wall), leaving room for large overhead cranes.

Monorail spans of 40' or more allow multiple work areas to be covered by a single fall protection system.

Coverage Area



Application Options

- Single, dual, or multiple tracks for one, two, or multiple workers
- Optional locking mechanisms keep system locked in place during use or storage
- Larger systems using three or more arms typically have chainwheel assists or electric motors
- Available as standard kits or custom engineered solutions

Design

Trussed track hangs from two or more arms that use boom locks to fold away when not in use

Support Structure

Arms attach to existing building columns or to new freestanding columns

Advantages

- System folds out of the way for overhead cranes
- Ideal for narrow bays with inaccessible ceilings
- Excellent for space-restricted facilities
- Span multiple work areas with one system

Examples

- Railroad & Truck Transportation Facilities
- Utilities
- Food Processing Facilities
- Petroleum & Coal Processing
- Plastics & Rubber Manufacturing
- Primary Metals Manufacturing

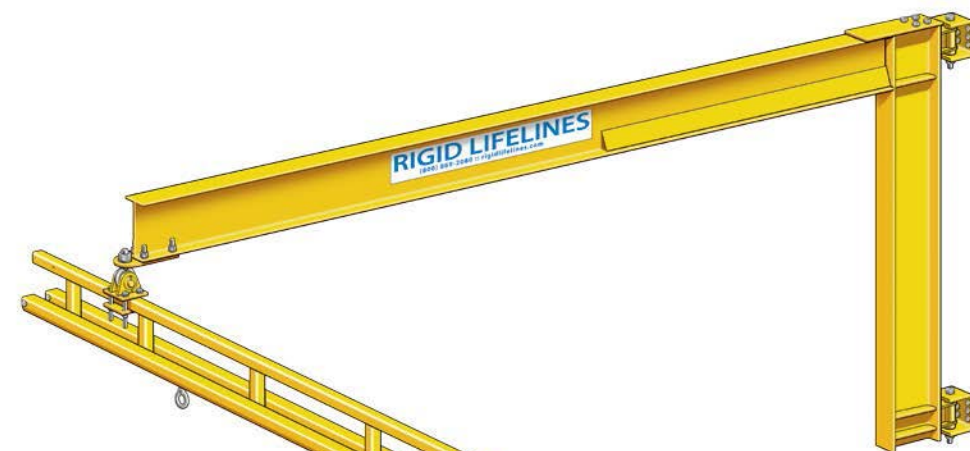

Fold-Away Wall or Column Mounted Monorail

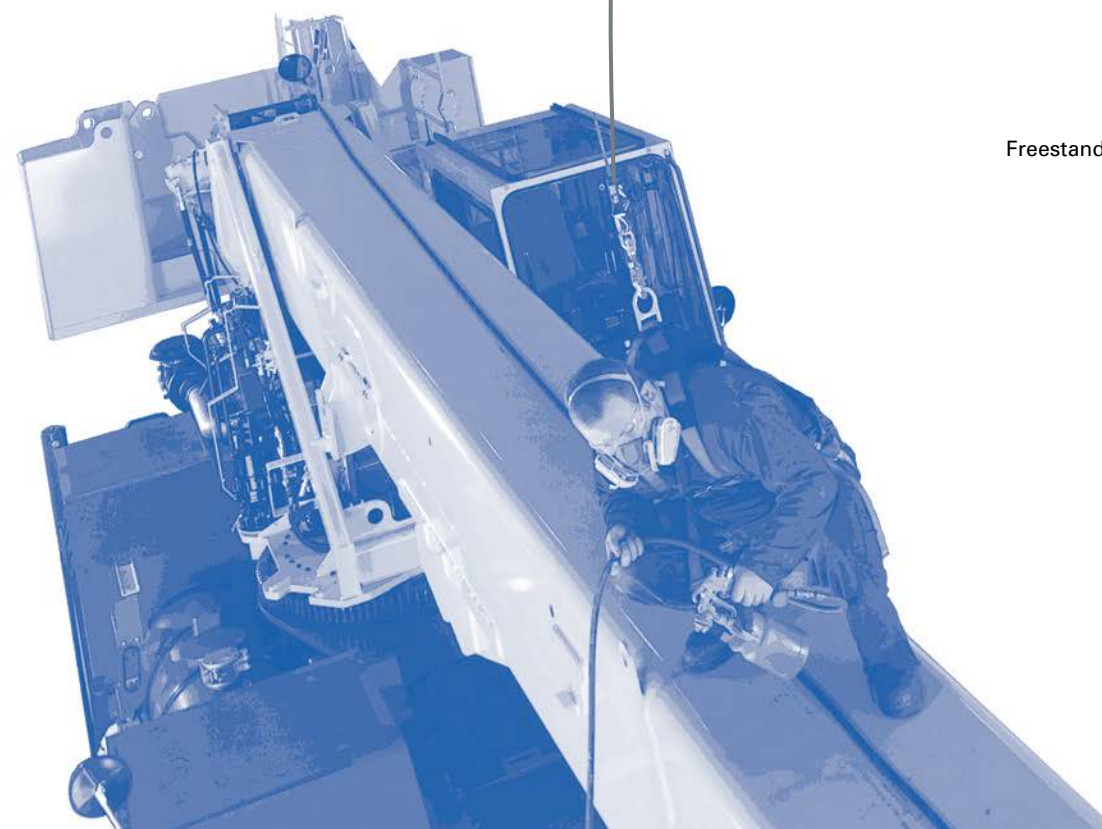

Freestanding options are available



ROLLING A-FRAME

Fall Protection Anywhere

Rigid Lifelines® Rolling A-Frames are the ultimate in portability for fall protection systems. Simply roll the system into position and lock into place.

Compared to the setup and breakdown of temporary guardrail systems, our Rolling A-Frames install much more quickly and are less likely to get in the way of production or maintenance processes.

Plus, our Rolling A-Frame systems can eliminate the need for a permanently installed system, while providing coverage to virtually every location in your plant. Available exclusively as custom engineered solutions for your facilities.



Coverage Area



Application Options

- Single, dual, or multiple tracks for one, two, or multiple workers
- Manual leveling jacks
- Outrigger arms with jack
- Foam-filled pneumatic tires
- Large diameter wheels to ease positioning
- Power drives

Design

Rolling A-Frame with trolley track installed on bottom of top beam

Advantages

Highly portable fall protection coverage

Examples

- Aircraft Maintenance & Manufacturing
- Large Vehicle Maintenance & Manufacturing
- Oil & Gas Drilling & Extraction
- Mining & Excavating
- Utilities

Rolling A-Frames



Fixed Height Steel



Adjustable Height Steel

SINGLE & MULTIPLE POST SUSPENSION

Wide Coverage, Fewer Materials

Rigid Lifelines® Single and Multiple Post designs deliver fall protection coverage to space-restricted areas and/or areas where conventional multiple columns cannot be installed due to obstacles.

Single and Multiple Post Systems can also be very economical, requiring fewer foundations and 60% less steel than conventional designs.

Single Post Systems

- Requires only one foundation
- Single post is ideal for very space-restricted or obstacle-filled areas
- Standard span lengths from 23' to 53', at virtually any height
- Custom designs including extra long cantilevered beams
- Multiple Post Systems
- Requires fewer foundations than other designs
- Span lengths start at 60' and, with additional posts, are unlimited
- Fall protection at virtually any height

Application Options

- Can be engineered for single or twin bays (tracks on both sides of posts)
- Single, dual, or multiple tracks for one, two, or multiple workers
- Portable designs with counterweighted bases are available for single post systems

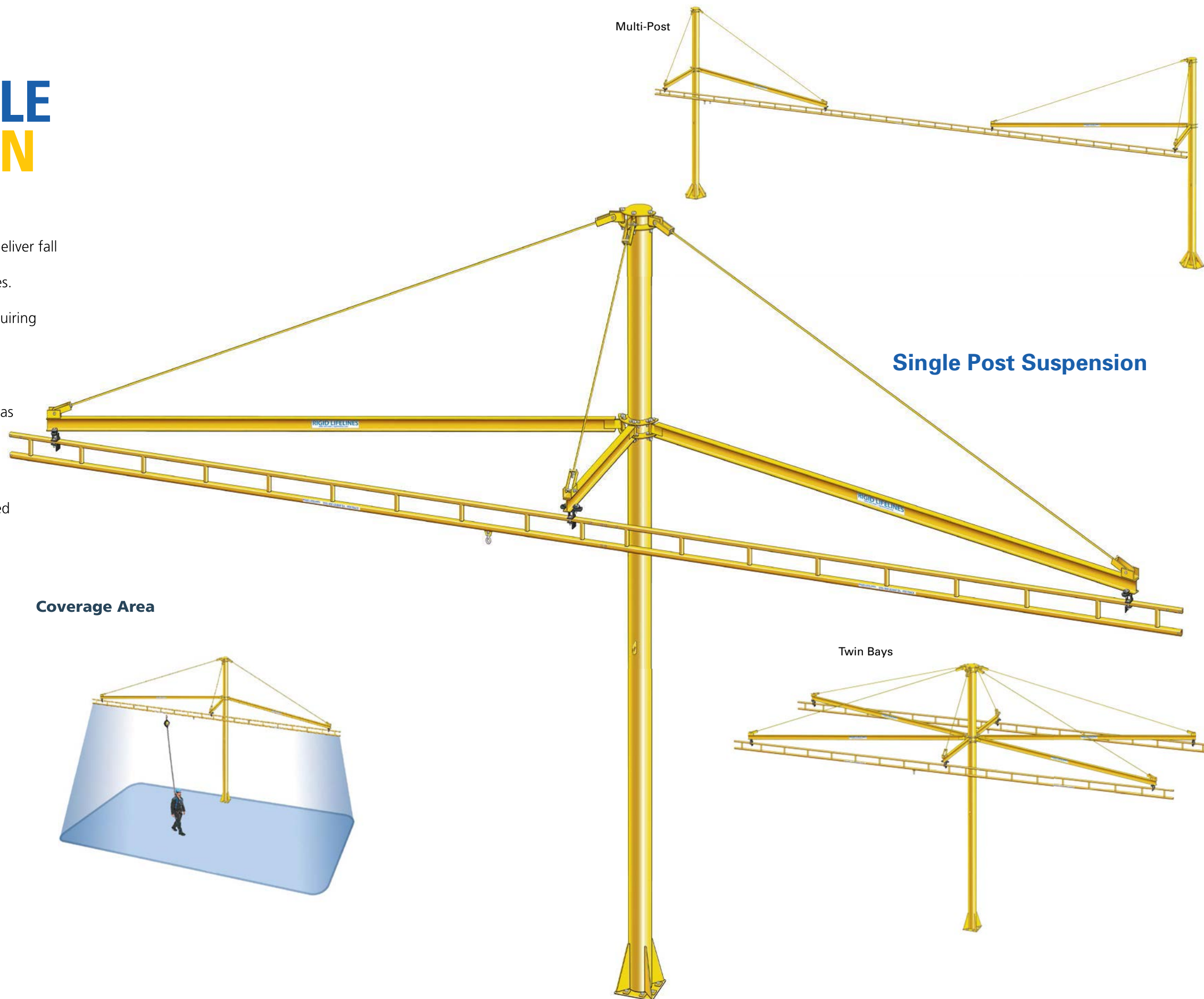

Coverage Area

Single Post Suspension

Twin Bays

Multi-Post

SWING ARMS

Compact, Circular Boom Systems
Eliminate Swing Fall Hazard

Rigid Lifelines® Swing Arm Systems provide a circular or semi-circular fall protection coverage area, making them ideal for small to medium-sized work areas.

Both the Swing Arm and its trolley follow the worker, keeping the trolley positioned directly above the user at all times and thereby minimizing swing fall hazard.

When not in use, the Swing Arm can be swung back to make way for overhead cranes. Fall protection spans range from 4' to 30', between 180° and 360° arm pivoting.

Application Options

- Can be engineered for single or twin bays (tracks on both sides of posts)
- Single, dual, or multiple tracks for one, two, or multiple workers
- Portable designs with counterweighted bases are available

Design

Track(s) attached to I-beam arm (cantilevered arm) that pivots between 180° and 360°

Support Structures

Swing Arm Systems are mounted either to:

- Existing wall columns, or
- Freestanding masts, either with a permanent base or a portable, counterweighted base

Advantages

- Minimizes swing fall hazard by constantly positioning trolley over user's head
- Swings out of way of overhead cranes
- Excellent for small to medium-sized work areas

Examples

- Utilities
- Water Transportation (e.g., water tankers)
- Food & Beverage Manufacturing
- Plastics & Rubber Manufacturing
- Primary Metals Manufacturing

Coverage Area



360° coverage area

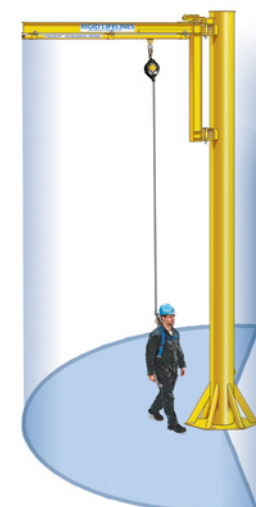

200° coverage area



XSPLATFORMS

Since 1995, **XSPlatforms** has built a compelling track record designing, manufacturing, assembling, inspecting, and managing rooftop fall protection systems worldwide.

XSPlatforms systems are made to measure and comply with all relevant legislation and regulations, and are ergonomic and durable. We train users, perform risk assessments, work in accordance with ISO 9001:2008 and provide consulting services worldwide.

Our customers can feel confident that we understand their business, and we can come up with innovative answers to increasingly complex questions, time and again. That is why we develop and engineer our products as if our own lives depend on them.

Whose Responsibility Is Rooftop Safety?

- Architect/Engineer
- Principal Contractor & Sub-Contractors
- Safety Manager/Engineer
- Facilities Manager
- Building/Facilities Owner

Where Can XSPlatforms Systems Be Used?

- Roof access points, including roof hatches and ladders
- Roof edges
- Around mechanical and engineered systems, such as HVAC units, solar panels, antennas, satellite dishes, lighting systems, signage, etc.
- Walkways
- Skylights
- And all other roof areas requiring access for inspections and general maintenance



WHY XSPLATFORMS CABLE SYSTEMS?

Why Specify XSPlatforms Horizontal Lifeline Systems For Rooftop Fall Protection?

Reliability

XSPlatforms is the first in the industry to be certified by the TÜV quality institute to ISO 9001:2008 with each step of the production – from design to shipping – performed to certified procedures. In addition, all parts have a unique serial number for quality assurance and traceability.

Optimal Freedom Of Movement with Continuous Attachment

XS Linked systems allow you to move freely – while always connected to the cable lifeline – as you traverse all anchor points, including curves, corners, and ridge tops. The XS Slider traveler (aka glider or trolley) moves smoothly along the lifeline, while permitting you to work on both sides of the steel cable path.

Integrated Fall Arrestor

The XS Impact and XS Impact 360° anchoring points contain an intelligent reaction mechanism that bends in the direction of the fall to absorb the shock. This Integrated Fall Arrestor must be used with a deceleration device – a Self-Retracting Lanyard (SRL) or a Shock-Absorbing Lanyard (SAL) – so forces remain below 900 MAF (Maximum Arresting Force in lbs).

Anchors Install 4x Faster

The XS anchor points use a separate base plate that you fasten directly to the roof's deck. In most cases, you just need one toggle fastener, compared to competitors' 4 or more fasteners per anchor.

Totally Top Mounted

Mounts completely on top of insulation and roofing material (e.g., membrane) to minimize disturbance to your roof. Plus, you eliminate the time-consuming and difficult "under the roof" work of finding structural mounting points as required by other systems.

Maximum Protection of Roof

XS Impact and XS Impact 360° anchoring points can be used on all roof types thanks to the high absorption properties of the integrated fall arrestor. The bending arrestor ensures that even extremely light and fragile roof constructions sustain only slight (or no) damage in the event of a fall.



Universal Anchors

Installation kits are available for a wide range of roofing surfaces and roofing decks – steel, concrete, hollow core concrete, and plywood as thin as 1/2" (12mm). Materials used are compatible with any sealing material – plastic or bitumen.

Longer Distance Between Anchors

The XS Impact series fall arrestor allows greater distances between two anchoring points: up to 49.2' (15m), depending on roof configuration. Fewer anchoring points means faster installation, inspections, and maintenance. Plus, the anchor's post height allows for the use of an SRL (Self-Retracting Lanyard), while lifting the connection point above any layers of roofing aggregate (rocks).

Easy To Inspect

All XS anchoring points can be inspected at any time, both visually as well as through a pull-test – without activating the anchoring point. The strength of the attachment to a concrete roof can be easily verified without disassembling the anchoring point.

Durability

Extensive use of high-grade stainless steel and aluminum means very low-maintenance for years to come.

Easy To Repair

After a fall, an anchoring point is easily replaced. Thanks to the separate base plates (which are usually not damaged by a fall and therefore do not need to be replaced) this is a simple, relatively inexpensive step that requires no new penetrations to the roof. Typically, the topping component is removed, the bending kit post is replaced, and the topping component is reinstalled; there is no need to cut or remove the cable.

Meets All International Rooftop Fall Protection Standards

ANSI/ASSE Z359.1 2007
 OSHA 1910.66, 1926.502
 CAN/CSA Z259



XS SYSTEMS SELECTOR GUIDE

Systems For Rooftop Fall Protection



XS Linked Cable System Full Roof Perimeter Fall Protection

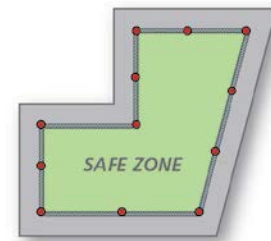

XS Linked Cable System Single/Multi Span Fall Protection



XS Single Anchor System Point to Point Fall Protection

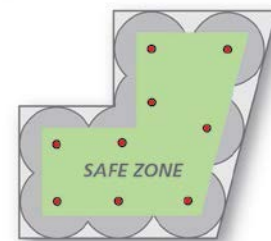

XS Guardrails Full Roof Fall Protection

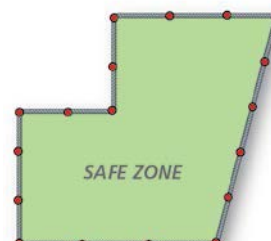

XS System Selector Guide	XS Single Anchor System <i>Point to Point Engineered Fall Arrest System</i>	XS Linked Cable System <i>Single/Multi Span Engineered Fall Arrest System</i>	XS Linked Cable System <i>Full Roof Perimeter Engineered Fall Arrest System</i>	XS Guardrail Systems
Protection Level	★ Budget Fall Protection	★★ Economical Fall Protection	★★★ Practical Fall Protection	★★★★ Optimal Fall Protection
Main System Components	XS Globe or XS Impact 360° Anchor Points	XS Cable (lifeline), XS Impact Anchor Points, XS Slider Pro	XS Cable (horizontal lifeline), XS Impact Anchor Points, XS Slider Pro	XS Guardrails
Maximum Number of Users	1 per anchor point	4 per span/system	4 per span/system	No limit
Required User Training and System Knowledge	Advanced	Intermediate	Basic	None
Maximum Distance Between Anchor Points/Supports	Up to 20' (6m)	Up to 40' (12.2m)	Up to 40' (12.2m)	8' (2.44m)
Roof Type	Metal, Wood, Concrete, Hollow Core Concrete, Standing Seam	Metal, Wood, Concrete, Hollow Core Concrete, Standing Seam	Metal, Wood, Concrete, Hollow Core Concrete, Standing Seam	No limits
Installation (All are top-mounted onto any roof type/surface)	Multiple anchor points normally placed up to 20' (6m) apart and at least 13' (4m) from roof's edge.	Permanent stainless steel cable horizontal lifeline system installed on roof areas where specific worker access is required. The use of additional Globe anchors may be required to minimize severe swing fall concerns.	Permanent stainless steel cable horizontal lifeline system installed along the perimeter of the roof, normally set back at a distance of 6' to 12' (2m to 4m) from the edge.	Fast-installing guardrail systems with straight, curved or folding uprights (posts). Freestanding weighted systems are either permanent or temporary.
Key Properties	Worker must approach and attach to anchors from a safe zone.	Promotes "hands free" horizontal mobility. Points of access must be identified and swing fall hazards addressed.	Promotes "hands free" horizontal mobility. Perimeter coverage allows for unlimited points of system access for workers.	No user knowledge needed.
North American Standards	ANSI/ASSE Z359.1 2007 OSHA 1910.66, 1926.502 CAN/CSA Z259			

Warning - When selecting a system, if the required scope of work at any time exposes a worker to a fall hazard, they must attach to the XS system with a deceleration device or lanyard that has a 900 lb MAF rating. If it is determined that the required scope of work will not expose a worker to a fall hazard, then a fixed length lanyard or device may be used as part of a fall restraint system. All systems are designed for worst case fall arrest and therefore Rigid Lifelines recommends the use of devices and lanyards rated with a 900 lb MAF.



XS LINKED CABLE SYSTEMS

Systems For Rooftop Fall Protection

Experience the patented design of XSPlatforms

Permanent Rooftop Anchor fall protection systems. XSPlatforms uses a versatile design that functions on steel, concrete, wood, or metal decking roof materials for any angle. This system is perfect for use on commercial buildings such as industrial warehouses, hotels, casinos, offices, and all types of manufacturing plants. With three different types of anchorages, it's easy to find a solution that can address almost any application. Explore the illustrations below to learn more about common XS system designs and the main components.

XS Linked Cable Systems can be installed up to 4 times faster than other systems thanks to the patented XS Toggle Anchor design (XS Toggle Anchors available on all XS anchor systems). The XS Toggle Anchor only requires one hole to be drilled during installation, unlike other rooftop systems that can require up to four holes per anchorage (if not more).

The XS anchor design also allows the fall protection installation process to be more efficient by only requiring anchorage installation every 40 feet. Plus, minimizing the number of holes that need to be drilled will dramatically reduce damage to the actual roofing material. Remember, fewer holes will lower the opportunities for leaks.

Roof Penetration Comparison

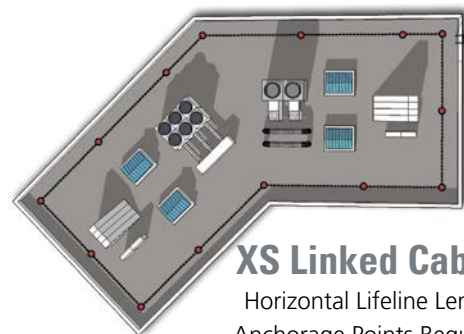

XS Linked Cable System

Horizontal Lifeline Length (cable)	480'
Anchorage Points Required (total)	14
Roof Penetrations (total)	14

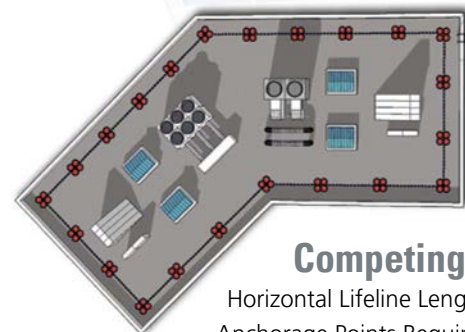

Competing Systems

Horizontal Lifeline Length (cable)	480'
Anchorage Points Required (total)	22
Roof Penetrations (total)	88

Flat Roof Applications



A XS Globe Anchor
Used as a stand-alone anchor, either in a Point-to-Point system, or on corners of a roof in an XS Linked Cable System to prevent the swing effect in case of a fall. XS Globe Eye with 360° rotation mounted on an XS Base Plate.

B XS Intermediate
The XS Intermediate mounted on an XS Impact Anchor.

C XS Edge 45°
The XS Edge 45° enables the direction of the lifeline cable to be changed. Features an XS Edge 45° with an XS Impact Anchor.

D XS Terminal Clip
The XS Terminal Clip is used to close an XS Linked Cable System and can be used on a corner or straight run. It features an XS Startpoint, XS Hold, and XS Tensioner mounted to an XS Impact Anchor.

E XS Edge 90°
The XS Edge 90° enables the direction of the lifeline cable to be changed. Features an XS Edge 90° with an XS Impact Anchor.

F XS Tensioner II
The XS Tensioner II features an XS Startpoint, XS Hold, and XS Tensioner mounted to an XS Impact Anchor.



G XS Terminal
The XS Terminal features an XS Startpoint, XS Hold, mounted to an XS Impact Anchor.

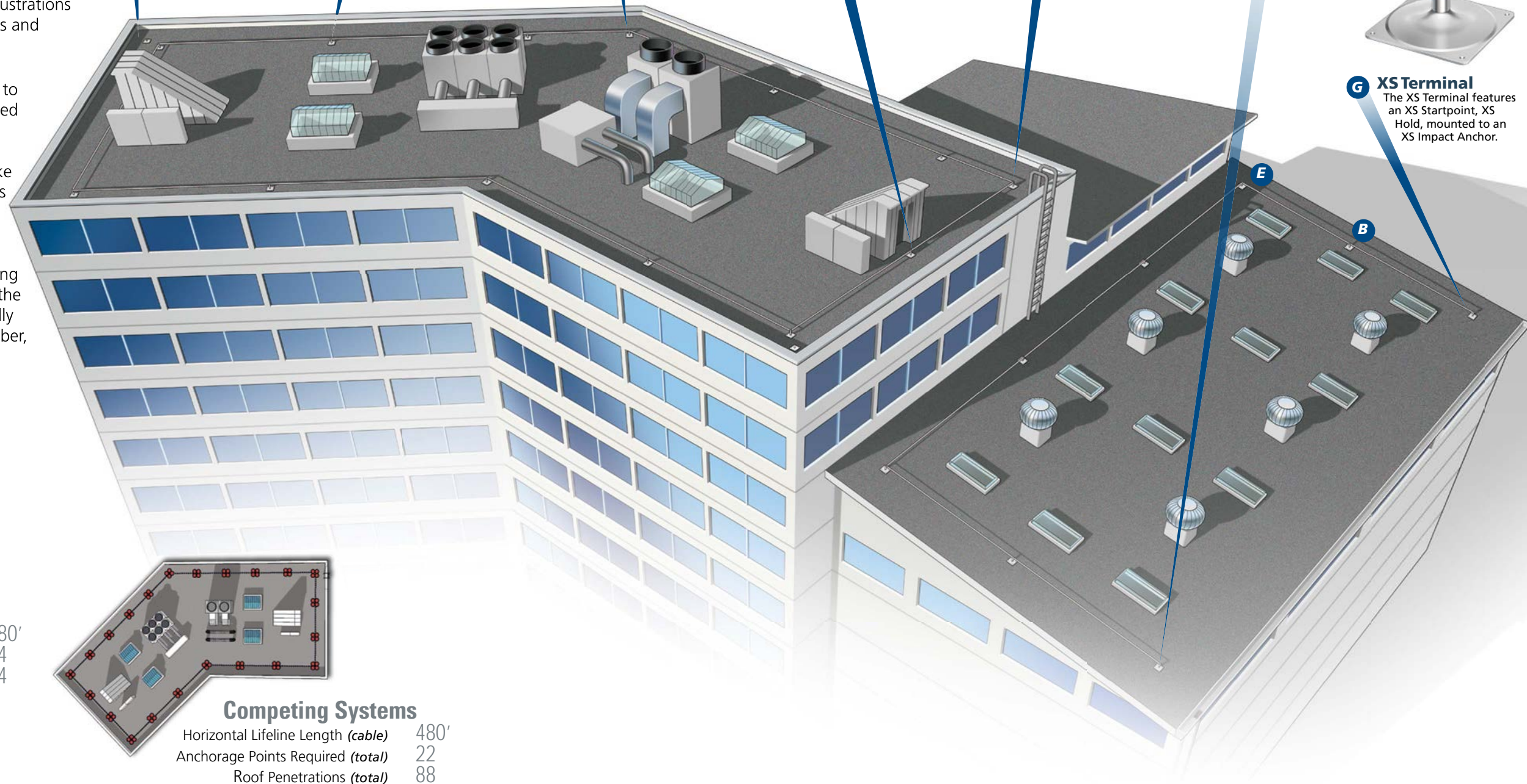

Sloped Roof Applications

LINKED CABLE SYSTEM COMPONENTS

Basic Component Overview

XS Impact – 11100

- The XS Impact can be used to support the XS Linked Cable System or as a stand-alone anchorage point.
- The anchorage point conforms to ANSI/ASSE Z359.1 2007, OSHA 1910.66, 1926.502, CAN/CSA Z259.
- The anchor's bending kit fall arrestor will not be activated until a force of 675 lbf (3kN) is applied. The anchor is tested against a continuous force of 2250 lbf (10kN).
- The ultimate strength after deployment is greater than 4500 lbf (20kN).
- Features an aluminum base plate with a stainless steel AISI 304 (316 available) threaded receiver (aka "throat") that accepts the bending kit post.



XS Base Plate – 11110

- Aluminum base plate with a stainless steel AISI 304 (316 available) threaded receiver (aka "throat") that accepts the bending kit post.
- Attachment of the XS Base Plate depends on the roof's deck material.
- Use XS Toggle Anchor (11300) on wooden or steel roof decks and the XS Mechanical Anchor (11400) on concrete or hollow-section concrete roofs.

XS Bending Kit Posts – 11125 and 11126

- Bending Kit Post Fall Arrestor will not be activated until a force of 675 lbf (3kN) is applied. The anchor is tested against a continuous force of 2250 lbf (10kN). The ultimate strength after deployment is greater than 4500 lbf (20kN).
- The 11125 model is made from aluminum and 304 grade stainless steel.
- The 11126 model is made from aluminum and 316 grade stainless steel.



XS Toggle Anchor – 11300

- The XS Toggle Anchor is used for fixing the anchorage point to steel and 3/4" (18mm) or thicker plywood roof deck.
- Stainless steel AISI 304 (316 available).



XS Mechanical Anchor – 11400

- The XS Mechanical Anchor is used for fixing the anchorage point to concrete and hollow core concrete (strength class at least C40/50 or 5800 psi).
- This is a Fischer anchor specially developed for high strength mounting in concrete.
- Stainless steel AISI 304 (316 available) with galvanized steel expansion anchor ("sleeve").



XS Globe Eye – 11210

- The XS Globe is used as a stand-alone anchorage point.
- Can be mounted to the XS Base Plate. The XS Globe Eye rotates 360°, allowing you to move in any direction.
- The anchorage point meets ANSI/ASSE Z359.1 2007, OSHA 1910.66, 1926.502, CAN/CSA Z259.
- Stainless steel AISI 304 (316 available).



XS Safety Eye 360° – 11260

- Replacement topping component for the XS Impact post.

XS Terminal (Hold) – 12230

- One end is swaged to the lifeline. The other end is connected to an XS Impact anchorage point, with a stainless steel AISI 304 socket head screw M12 x 35mm.
- Stainless steel AISI 304 (316 available).



XS Tensioner II system – 12300

- Consists of XS Startpoint, XS Hold, and XS Tensioner.
- The XS Startpoint (and its stainless steel threaded shaft) acts as the attachment point between the XS Hold and the XS Tensioner.
- The XS Tensioner is used for tightening the cable. Correct tension of the cable ensures correct functioning of all system components in the event of a fall.
- Stainless steel AISI 304 (316 available).



LINKED CABLE SYSTEM COMPONENTS

Basic Component Overview

XS Intermediate – 12400

- The XS Intermediate positions the lifeline cable on a XS Impact post so you can freely pass by the anchor without needing to disconnect from the lifeline.
- It can be installed in many different configurations and at regular intervals to ensure the optimum distribution of forces along the lifeline.
- Stainless steel AISI 304 (316 available).



XS Edge 45° – 12500

- The XS Edge 45° enables the direction of the lifeline cable to be changed. It is shaped specifically to allow you to move safely without needing to disconnect from the lifeline.
- Stainless steel AISI 304 (316 available).



XS Edge 90° – 12600

- The XS Edge 90° enables the direction of the lifeline cable to be changed. It is shaped specifically to allow you to move safely without needing to disconnect from the lifeline.
- Stainless steel AISI 304 (316 available).



XS Slider – 12810

- The XS Slider traveler (aka glider or trolley) connects the deceleration device (SRL or SAL) to the horizontal lifeline (cable).
- Its unique shape and design enables the smooth passage through anchorage points without the need to ever disconnect from the lifeline.
- Users are able to connect or disconnect at any location along the cable.
- The locking design makes inadvertent disconnections virtually impossible.
- Stainless steel AISI 304 (316 available).



XS Cable – 13100

- Stainless steel AISI 316.
- Diameter: 5/16" (8mm).
- Construction: 7x7 (7 wire bundles, 7 wires per bundle).



XS Xtrusion – 11800

- For installations on standing seam roofs.
- The XS Xtrusion is used to support the XS Linked Cable System or as a stand-alone anchorage point in combination with an XS Safety Eye 360°.
- Includes the Bending Kit Fall Arrestor.
- Stainless steel AISI 304 and aluminum.



Extremity & Corner Fixation Screws – 11500

- The extremity and corner fixation is a set of screws used for fixing corners and extremity posts of the XS Linked lifeline system onto steel and wooden roof decks. The screws are inserted into the pre-drilled holes in each corner of the XS Base Plate and XS Base Plate Extra.
- The length of the screws depends on the thickness of the insulation material. The screws provided are suitable for most applications. If you require different screws, please contact our sales department.
- Make sure that the Ø6 screws you use are at least 1.5" (35 mm) longer than the thickness of the insulation!
- Screws are galvanized steel.



XS Base Plate Extra – 11700

- The XS Base plate extra is used beneath the XS Base Plate for installing the XS Impact, XS Globe, and XS Impact 360° on plywood decks with a minimum thickness of 3/4" (18mm).
- Aluminum.



XS Adapter Set – 11710

- The XS Adapter is used under the XS Base Plate to assemble the XS Impact, XS Globe, and XS Impact 360° on plywood decks with a minimum thickness of 1/2" (12mm).
- The aluminum adapter plate is mounted to the roof using the four provided M10 XS Toggle Anchors.
- Stainless steel AISI 304 (316 available).



FAST ANCHOR INSTALLATION

For Steel Deck Roofs

Features the XSToggle Anchor; suitable for all types of steel roofs (minimum 0.03" or 0.75mm thick).

XS Impact Anchor Installation:

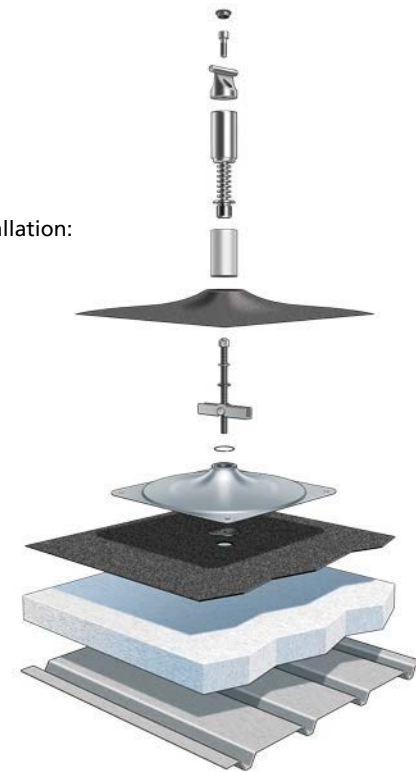

XS Globe Anchor Installation:

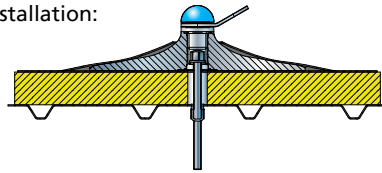

For Concrete Deck Roofs

Features the XS Mechanical Fischer anchor for high-strength mounting into concrete and hollow core concrete (strength class at least C40/50 or 5800 psi).

XS Impact Anchor Installation:

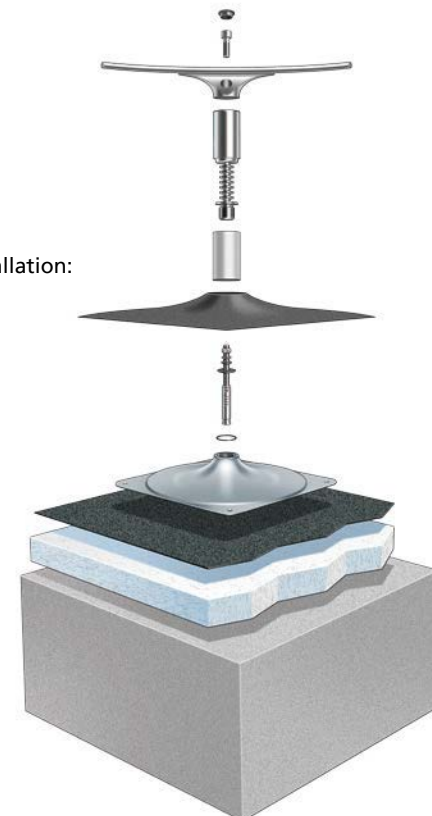

XS Globe Anchor Installation:

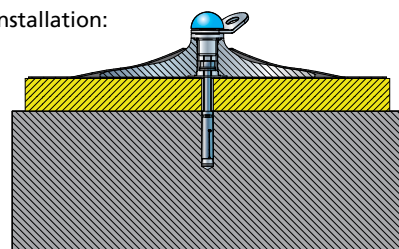

For Wooden Deck Roofs

Min. 3/4" (18mm) Plywood

Featuring the XSToggle Anchor and XSBase Plate Extra.

Shown here with a set of four screws for extremity and corner fixation; the screws go through the pre-drilled holes in both the XSBase Plate and XSBase Plate Extra. The extremity and corner fixation screws (11500) are also used on steel roofs, as well as wooden ones.

XS Globe Anchor Installation:

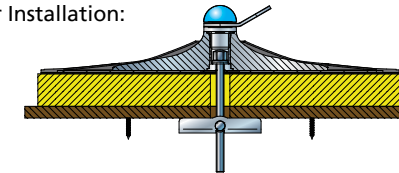

For Wooden Deck Roofs

Min. 1/2" (12mm) Plywood

Features the XS Adapter Set: the aluminum adapter plate is mounted using four XSToggle mini anchors.

Note: the waterproofing layer (aka "capping sheet") is typically specified by your roofer.

XS Globe Anchor Installation:

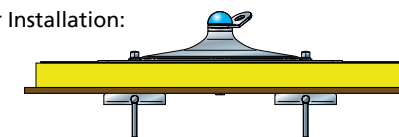

XS Impact Anchor Installation:



XS Impact Anchor Installation:



XS Curved

XS GUARDRAIL SYSTEMS

Maximum Functionality & Aesthetics

XS Fixed

The XS Fixed is a freestanding, straight upright for securing the guardrail tubes in position.

XS Flex

Maximum protection with minimal visual impact. The straight guardrails in the XS Guardrail series are also available in a collapsible (XS Flex) version, making them only visible when roof work is actually being performed. The XS Flex is a freestanding, fold-away upright for securing the guardrail tubes in position.

XS Curved

The XS Curved is a freestanding curved upright for securing the guardrail tubes in position. The curved designs provide extra safety (by keeping people further from the roof edge) and, thanks to their attractive design, can accentuate the architectural design of your building.



XS Fixed



XS Flex

XS GUARDRAIL SYSTEMS

Maximum Functionality and Aesthetics

No Roof Penetrations, No Leaks

XS Guardrails use a freestanding design that requires no drilling into your roof, so your roof's waterproofing capacity is unaffected. Long stand bases (beams) and concrete counterweights keep the freestanding system securely in place.

Because the system does not need to be attached to the roof, it is suitable for virtually any roof type, including standing seam roofs, built-up roofs (BUR), and secret fix roofs.



Flexible: Any Installation Can Be Permanent or Temporary

Suitable for almost all roofs with slopes between 0° and 15°, XS Guardrails can also be used on working platforms and technical terraces. Whether permanent or temporary, the installation is done virtually the same way. (One exception: XS Reclamps can be more convenient for temporary installations than using XS Clamps.)

Permanent or temporary: XS Guardrails give facility owners the ultimate in system flexibility.

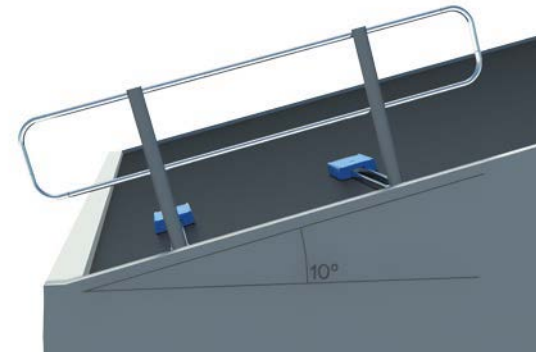

The Highest Level of Protection, With No User Training Needed

XS Guardrails turn your entire rooftop into a safe access area with:

- No limits on the number of users
- No Personal Protection Equipment (PPE) needed
- No special precautions required
- No specific fall protection training necessary



Install 800' to 1000' A Day

Two people can install between 800' to 1000' (250 to 300 meters) of guardrail per day. Because the components 'click' into place, practically no tools are required – just one special wrench. For increased installation safety and speed, the knee and hand rails are clicked into place from above, instead of passed through the uprights from the side.

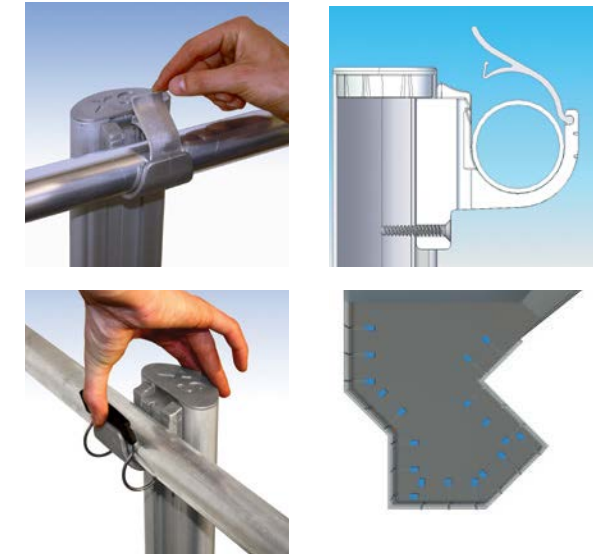

Traceability Means Accountability

For 100% quality accountability, XSPlatforms gives every product its own production number in combination with its production date.



Optional Toe Plate

For buildings with flat roofs that have no parapets or lips, the XS Guardrail can be easily equipped with an integrated toe plate to prevent materials from rolling or sliding off the roof.



MAIN COMPONENTS

XS Guardrail System

XS Fixed - 21100

These straight uprights are placed 8' (2.44m) apart to support the XS Guardrails. Each 21100 order includes the following:

- 21100** - XS Fixed – aluminum upright
- 21110** - XS Clamp (2x) – aluminum
- 21120** - Self-Drilling Screw - stainless steel AISI 304 (connects horizontal beam to upright)
- 21130** - Hex Bolt M8 - stainless steel AISI 304 (connects horizontal beam to XS-Mass)
- 21140** - Closure Ring - stainless steel AISI 304 (plain washer used with self-drilling screw 21120)
- 21150** - Protection Sole – rubber (goes under the horizontal beam, directly beneath the upright beam, to protect the roof)
- 21160** - XS Reclamp (2x) - stainless steel AISI 304 with plastic cap (used to clamp the guardrails tubes in a temporary XS-Guardrail system)
- 22300** - XS Mass – PVC-coated concrete, 54 lbs (20.4 kg)

Note: Horizontal Beams 22100 (3m) or 22200 (6m) are sold separately.

XS Flex – 21200

These foldable uprights are placed 8' (2.44m) apart to support the collapsible XS Guardrails. Each 21200 order includes the following:

- 21300** - XS Flex – aluminum upright
- 21110** - XS Clamp (2x) – aluminum
- 21130** - Hex Bolt M8 - stainless steel AISI 304 (connects horizontal beam to XS-Mass)
- 21150** - Protection Sole – rubber (goes under the horizontal beam, directly beneath the upright beam, to protect the roof)
- 21160** - XS Reclamp (2x) - stainless steel AISI 304 with plastic cap (used to clamp the guardrails tubes in a temporary XS-Guardrail system)
- 22300** - XS Mass – PVC-coated concrete, 54 lbs. (20.4 kg)

Note: Horizontal Beams 22100 (3m) or 22200 (6m) are sold separately.



XS Curved – 21300

These curved uprights are placed 8' (2.44m) apart to support the XS Guardrails. Each 21300 order includes the following:

- 21300** - XS Fixed – aluminum upright
- 21110** - XS Clamp (2x) – aluminum
- 21120** - Self-Drilling Screw - stainless steel AISI 304 (to connect horizontal beam to upright)
- 21130** - Hex Bolt M8 - stainless steel AISI 304 (to connect horizontal beam to XS Mass)
- 21140** - Closure Ring - stainless steel AISI 304 (washer used with 21120 self-drilling screw)
- 21150** - Protection Sole – rubber (goes under the horizontal beam, directly beneath the upright beam, to protect the roof)
- 21160** - XS Reclamp (2x) - stainless steel AISI 304 with plastic cap (used to clamp the guardrails tubes in a temporary XS Guardrail system)
- 22300** - XS Mass – PVC-coated concrete, 54 lbs. (20.4 kg)

Note: Horizontal Beams 22100 (3m) or 22200 (6m) are sold separately.

XS Standing Seam Kit – 21190

Used to make an anchorage point on standing seam roofing for support of the XS Guardrail system. Meets ANSI/ASSE Z359.1 2007, OSHA 1910.66, 1926.502, CAN/CSA Z259.

Includes:

- XS Base Steel Deck - aluminum
- XS Mounting Kit - stainless steel AISI 304 (316 available)
- Gasket – rubber

XS Built-Up Roof (BUR) Kit – 21191

Used to make an anchorage point on a roof using a built-up roof (BUR) membrane for the support of the XS Guardrail system. Meets ANSI/ASSE Z359.1 2007, OSHA 1910.66, 1926.502, CAN/CSA Z259.

Includes:

- XS Base Steel Deck - aluminum
- XS Mounting Kit - stainless steel AISI 304 (316 available)
- Gasket – rubber

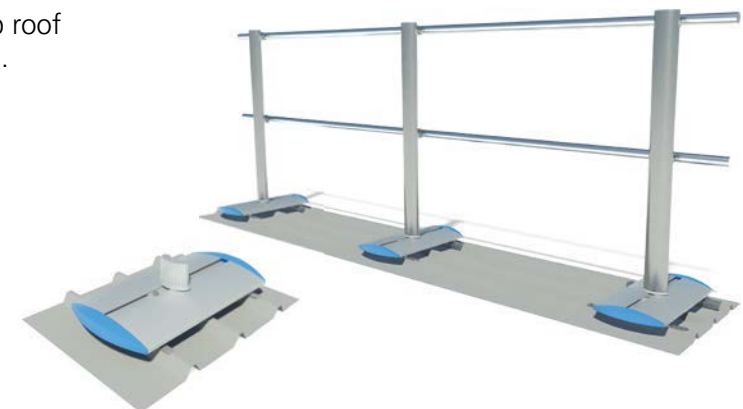

MAIN COMPONENTS

XS Guardrail System

XS Secret Fix Kit – 21192

Used to make an anchorage point on a roof with a secret fix profile for support of an XS Guardrail system. Meets ANSI/ASSE Z359.1 2007, OSHA 1910.66, 1926.502, CAN/CSA Z259.

Includes:

- XS Base Steel Deck - aluminum
- XS Mounting Kit - stainless steel AISI 304 (316 available)
- Gasket – rubber

XS Clamp – 21110

Used to clamp the guardrail tubes to the upright in a permanent or temporary XS Guardrail system. Aluminum.

XS Reclamp – 21160

Used to clamp the guardrail tubes to the upright for a temporary XS Guardrail system. Stainless steel AISI 304 with plastic cap.

XS Edge 45° – 21400

Used to construct a 45° bend in an XS Guardrail system. Two pieces are needed for each corner. Aluminum.

XS Edge Xtra – 21450

Used to construct a custom angle bend in an XS Guardrail system. The bending connection is fixed by the installer by tightening a hex screw. Two pieces are needed for each corner. Aluminum.

XS Edge 90° – 21500

Used to construct a 90° bend in an XS Guardrail system. Two pieces are needed for each corner. Aluminum.

XS Connect – 21600

Used to connect the handrail to the knee rail in an XS Guardrail system. Aluminum.

XS Connected – 21700

Used to make a connection between an XS Guardrail system and a wall. Tube is welded to mounting flange with 4 pre-drilled mounting holes. Two pieces are needed for each wall connection. Stainless steel AISI 304. Screws for mounting to wooden walls, concrete walls, brick/stone walls, and steel walls sourced locally.



XS Joint – 21800

Used to make connections between XS Tube, XS Edge 45°, XS Edge 90°, and XS Connect components. Aluminum.

XS Tube – 22100 / 22200

Used as a hand or knee rail in XS Guardrail systems. Clamps into the XS Fixed, XS Flex, and XS Curved uprights using the XS Clamp or XS Reclamp. Aluminum.

22100 is 9.84' (3m) long
22200 is 19.68' (6m) long

XS Entry – 21900

Used as access door to a roof, caged ladder, or hatch. The XS Entry is placed between two uprights as part of an XS Guardrail system. Aluminum.

XS Mass – 22300

Used as counterweights for the XS Fixed, XS Flex, and XS Curved uprights. The counterweights are fixed to the horizontal (base) beam by an M8 hex bolt. For all free ends, a second stacked counterweight is required; the two weights are fixed to the horizontal beam via an extra-long hex bolt. 54 lbs. (20.4 kg). PVC-coated concrete.

XS Toe Board – 22400 / 22500

Used to add a toe board to an XS Guardrail system on flat roofs that have no parapets or lips so as to prevent materials from rolling or sliding off the roof. The XS Toe Board is installed by clicking it onto the XS Toe Board Bracket and then tightening it with a screw. Aluminum.

22400 is 4.46' (1.36m) long
22500 is 7.41' (2.26m) long

XS Toe Board Bracket — 22410 / 22420

The XS Toe Board Bracket is installed by screwing it onto the XS upright. (Uses the same screw as is used for fastening the XS upright to its horizontal beam.) Aluminum.

22410 - XS Toe Board Bracket
22420 - XS Toe Board Bracket End



ELEVATED WORKSITE ANALYSIS

Project Name: _____

Date: _____

Project Description: _____

Competent person (print): _____

Competent person (sign): _____

Elevated Surface Work Plan

Questions to Consider

Answers or Solutions

Does company JSA (Job Safety Analysis) mitigate and address this type of work involving unprotected elevated locations?	
What is the job to be done?	
What is the location? How high is it?	
What is the working or walking surface like?	
Are there any environmental factors to consider? (Heat, cold, slippery, wet, wind, glare, etc.)	
Are there any hazards nearby or underneath that are exposed or could become exposed in an impact (plumbing lines, electrical exposures, protruding or impalement hazards, etc.)?	
Will the work require special personal protective equipment (besides fall protection)?	
How many will be working (buddy system)?	
What is the method of access to elevated work site?	
How will necessary and required tools and equipment be made available to the work location?	
Does company need to prevent activities from resulting in hazards to those below by following appropriate barricading methods to keep non-essential personnel away?	
Is it possible to relocate the work being done to a lower level to prevent a fall hazard.	
Can the work be safely completed from a ladder instead?	
Can an aerial (boom) lift or scissors lift be used instead (is the worker qualified to operate one?)	
If not, can the company install portable guardrails for the job?	
If not, can the company use fall restraint?	
If not, can the company use fall arrest?	If yes, see following pages for Fall Hazard Analysis for Fall Arrest and Rescue Plan
Other?	

Fall Hazard Analysis for Fall Arrest

Questions to Consider

Answers or Solutions

Are there any existing approved anchorage points that can be used? Where?	
Are they labeled as an approved anchorage point, capable of holding 5000 lbs or more, or designed and installed to withstand a 2 to 1 safety factor as determined by a designated, qualified person?	
If not, can approved pre-manufactured or engineered anchorages be installed?	
Does the company have the right equipment (full body harness, minimum length lanyard, shock absorber, connecting hardware, I-beam strap, self-retracting lifeline, etc.) to complete a suitable personal fall arrest system (PFAS) for the application?	
Is there suitable clear fall distance to prevent contacting a lower level or object below?	
If yes, what deceleration device(s) would be suitable?	
If no, please describe the anticipated fall event to include any and all impediments.	
What is between the at risk worker and the ground or floor below?	
What will the worker hit on the way down?	
How would the worker be rescued if suspended in a harness? (Develop rescue plan)	

Rescue Plan

A rescue plan must be developed whenever fall arrest systems are in use and when personnel may not be able to self-rescue should a fall occur.

What is the emergency contact information of professional rescue services available, such as the local Fire Department, and what are the instructions for summoning immediate assistance?	
Is rescue equipment immediately available for this location? (Ladders, aerial devices, elevating work platforms, tripods, additional harnesses, controlled devices, elevating work platforms, tripods, additional harnesses, controlled descent devices, winches, pulleys, etc.)	
What obstructions are in the way of reaching the suspended worker?	
How will rescue be assured within 15 minutes of the occurrence of a fall to minimize the risk of further injury or death due to suspension trauma?	
How will the safety of the rescuers be assured as well as that of the suspended worker?	
What communication systems will be used between the suspended worker and rescue team?	

WARRANTY AND SERVICE POLICY

TEN-YEAR EQUIPMENT WARRANTY

Rigid Lifelines warrants the engineered track equipment, wearable end truck wheels, and Anchor Trolley™ wheels and teeth to be free from defects in material and workmanship for a period of ten (10) years commencing on the date of installation.

TWO-YEAR EQUIPMENT WARRANTY

Rigid Lifelines warrants XSPlatforms Fall Protection components to be free from defects in material and workmanship for a period of two (2) years commencing from the date of installation.

ONE-YEAR EQUIPMENT WARRANTY

Rigid Lifelines warrants the motorized products and drive components to be free from defects in material and workmanship for a period of one (1) year, commencing on the date of shipment to the first retail purchaser ("Purchaser").

Rigid Lifelines warrants all Rigid Lifelines fall protection soft goods, devices, connectors, and accessories to be free from defects in material and workmanship for a period of one (1) year, commencing on the date of shipment to the first retail purchaser ("Purchaser").

Rigid Lifelines is dedicated to offering superior service and quality products to all of our customers. If you would like to contact a customer service representative, please call the following number: **1 (800) 869-2080**. We will be happy to assist you in any way that we can.

These warranties do not extend to equipment which has been subject to misuse, use in excess of rated capacity, negligent operation, use beyond Rigid Lifelines published service factors, improper installation or maintenance, adverse environments, and does not apply to any equipment which has been repaired or altered without Rigid Lifelines written authorization. This warranty is void for any product that is designed to deform or absorb energy during a fall event and needs to be replaced after a fall event has occurred.

Written notice of any claimed defect must be given to Rigid Lifelines within thirty (30) days after such defect is discovered. Rigid Lifelines obligation, and Purchaser's sole remedy under this warranty is limited to, at Rigid Lifelines discretion, the replacement or repair of the equipment at Rigid Lifelines factory or at a location approved by Rigid Lifelines. THIS WARRANTY IS EXPRESSLY IN LIEU OF ALL OTHER WARRANTIES WHATSOEVER WHETHER EXPRESS, IMPLIED, OR STATUTORY. SELLER MAKES NO WARRANTY AS TO THE MERCHANTABILITY OR FITNESS FOR A PARTICULAR PURPOSE OF THE EQUIPMENT AND MAKES NO OTHER WARRANTY, EITHER EXPRESS OR IMPLIED.

Rigid Lifelines shall not be liable, under any circumstances, for any indirect, special, or consequential damages including (but not limited to): lost profits, increased operating costs, or loss of production. This warranty shall not extend to damages including (but not limited to): lost profits, increased operating costs, or loss of production. This warranty shall not extend to any components or accessories not manufactured by Rigid Lifelines (example: casters), with the exception of the components, systems, or accessories involved with XSPlatforms, and purchaser's remedy for such components and accessories shall be determined by the terms and conditions of any warranty provided by the manufacturer of such components and accessories.

SERVICE POLICY

1. Obtain as much information as possible concerning the problem through personal observation by yourself or other authorized personnel familiar with the job and equipment: include model, serial and/or part numbers, voltages, speeds, and any other special identifying features. Be prepared to discuss the situation in detail.

2. All authorized labor charges will be based on straight time. Hourly rates, estimated man hours, and not to exceed total dollar amount required for corrections are to be agreed upon before authorization is given. There will be no allowances for overtime except in dire emergencies and then only with prior approval.

3. A verbal agreement may be reached immediately on both the method of correction and the approximate cost. A warranty authorization number will be assigned for the specific incident. A confirming written authorization will be forwarded to the distributor.

4. The distributor must send an itemized invoice, showing our release number or invoice number and warranty authorization number after authorized corrections have been made. A credit memo will be issued by accounting after the invoice has been received and approved. Warranty charges ARE NOT to be deducted from outstanding open account invoices under any circumstances.

5. Any field corrections made prior to an authorization by Rigid Lifelines will not be accepted as a warranty charge or the responsibility of Rigid Lifelines. Any modification to the equipment made without prior approval of the seller will void all warranties. A verbal authorization for modification may be obtained, in which event a warranty authorization number will be assigned for the specific modification. A confirming written authorization will be forwarded to the distributor.



WHY RIGID LIFELINES®?

Innovative & Easy to Use

When we design our products, we think about the people who use them. We strive to make our products easier to use, and we are pioneers of innovative fall protection system technology. Here at Rigid Lifelines we think in new ways that provide improved worker safety and productivity.

Consistently Meeting Requirements

Our engineers have designed thousands of fall protection systems for clients across North America. People choose our fall protection systems because they meet or exceed OSHA and ANSI Z359 requirements. No matter where you work or what type of tasks at height that you may need to perform, we aim to provide a fall protection system that meets your needs.

Experienced and Informed Team of Engineers

Our engineers serve on the ASSE/ANSI Z359 Fall Protection Code Writing Committee, ANSI sub-committees, and the Safety & Health Technology Committee of the Association of Iron & Steel Technology. By participating with these organizations, our engineers are able to keep a pulse on the latest changes in fall protection requirements and technology.

Bi-Coastal Manufacturing

We have manufacturing locations in Las Vegas, Nevada and Morgantown, Pennsylvania. These two locations make it easier for us to serve customers everywhere between the east and west coast.

Certified Manufacturing

Our welders are certified by the American Welding Society in steel (D1.1) and aluminum (D1.2) to ensure that every product we manufacture maintains quality production. Our manufacturing engineers also ensure that ISO 9001:2008 procedures are adhered to as part of a quality management system for superior process improvement.

CUSTOMER TESTIMONIALS



Mike Kerker - CAT **Senior Service Information Engineer**

The old fall protection system took time away from a person doing his job because we had to pull four or five guys off of their job to get the system into place. In some cases we had to move pallets and move things that were sitting on the floor out of the way.

We chose Rigid Lifelines® because of its flexibility. It provided us with much easier use. We can move the systems into place with the touch of a button. The guys really like it; they can maneuver it around and we've got almost 100% protection in this building because of it. We're moving machines in and out and we need to have the flexibility that Rigid Lifelines provides.

The guys have been using this system and have come back to me voluntarily and said that they really like it, and that it's easy to use. I would recommend Rigid Lifelines to anyone who asks. In fact, we have had different people from other facilities asking us what we use and I have passed on that we are very pleased with it.



Dennis Breden - North Star BlueScope Steel **Shipping and Raw Materials**

The system was constructed six months ago with implementation five months ago. At this point because we are probably on the front edge of the safety curve as far as truck driver safety in the steel industry, it hasn't affected productivity at all. That was the main reason why we went with a fall arrest system. Because if we would have went with any kind of physical structure, it would have created safety bays, and with our layout it would have created problems.

On average, there are 180 trucks per day that roll through here and due to that, the potential for falls is really pretty significant when you start throwing in environmental elements such as rain and snow. They just add further odds for a driver to fall off of their trailer. I would recommend the system for other steel mills. It's a pretty easily laid out system, and they were able to custom make it for what our needs were.



Jeff Bennett - State Garden **Safety Director**

I'm the safety director for the company, so I develop policies and procedures to keep people safe, through hazard analysis and things of that nature. I chose the XSPlatforms system because it was unique in and of itself. I couldn't find anything quite like it out there and it offered me the peace and security that when my guys are up here [on the roof], they're safe.

I like how the system was designed...It hooked up nice and I was very happy with the way the installation went. I would say that we don't have a lot of concerns, but my main concern is just making sure that [my workers] don't fall over the edge or get too close to the edge because human error is definitely a factor up here. Weather conditions can be a problem, but this system gives me peace of mind that on a slippery or icy surface, they're gonna be protected.

I think the [XSPlatforms] system is excellent. I think it's user friendly, and that it accomplishes everything that I need to accomplish for my guys and I'm very happy with it. Safety is a paramount importance because I want to make sure that folks go home the same way that they came in and this system here offers that sort of security for me. I would say that you should choose one of these systems for the ease of the install and the ease of hooking up and just for the peace of mind knowing that your people are gonna go home safe every day.



Dan Myers - Meyers/Besl Transport **Owner/Operator Truck Driver**

My name is Dan Myers, I'm an owner/operator truck driver. A lot of times, when we go places to pick up loads, we have to tarp them. Some of them are high, some of them are low, and it seems any more you need to put the fall arrest system on you. There were many times with the cable systems, I'd choose not to use it when I probably should, but you can't move around like you are supposed to. Because most of them are all big and bulky, they get all hooked up and bound up.

But the Rigid Lifelines system seems to be more free and you can move around. You don't even know you're wearing it and I just think that's one of the best things about it. A lot of times, you've got to carry your tarps or your straps back and this thing is not bothering you. It's real easy to get in and real easy to get out, and it's quick.

And because you don't have to worry about falling, you can move along pretty quick, get your job done, and get on the road. You don't make any money unless you're moving. I would absolutely hope everyone would get Rigid lifelines because it's safety for everybody.

LAWS & CODES

Fall Protection Standards (ANSI & OSHA)

Fall protection regulations make a distinction between whether you're in General Industry or the Construction Industry. This overview first discusses what is common to both industries.

The most important Fall Protection Code is ANSI Z359.2 "Minimum Requirements for a Comprehensive Managed Fall Protection Program." The ANSI fall protection standard Z359.2-2007 clearly defines all the duties and responsibilities that OSHA will require from an organization using fall protection. Furthermore, ANSI Z359.2 clearly defines issues that are generally not fully defined within OSHA law, such as hazard analysis, rescue plans, and anchorage requirements for fall restraint systems and work positioning systems.

Systems thought to originally be OSHA compliant may not be, specifically if the OSHA inspector uses the "General Duty Clause" to cite the more detailed ANSI Z359.2 Code.

A great starting reference for fall protection is the definitions section of Z359, available for free at: ASSE.org (search for "Z359.0").

General Industry – Fall Protection Codes

The most important standard for the safety of your general industry employees is ANSI Z359.2; the most important standard for federal law compliance is OSHA 1910.66 App C.

- ANSI Fall Protection Code Z359 (Nationally Recognized Safety Standard) is available for a nominal fee: search at ANSI.org.
- OSHA Fall Protection Code 1910.66 App C (Federal Law) is available for free: search at OSHA.gov.

Construction Industry – Fall Protection Codes

The most important standard for the safety of your construction employees is ANSI Z359.2; the most important standard from a federal law compliance perspective is OSHA 1926. The construction industry-specific fall protection code is ANSI A10.32.

- ANSI Z359 Fall Protection Code (Nationally Recognized Safety Standard)
- ANSI A10.32 Construction Fall Protection. Both ANSI standards are available for a nominal fee: search at www.ansi.org.
- OSHA 1926 Subpart M App C (Federal Law), available for free: search at www.osha.gov.

For a comprehensive list of ANSI and OSHA Fall Protection related standards, visit our Regulations-Standards page on: RigidLifelines.com



HOW TO BUY

Qualified Distributors Throughout North America

Rigid Lifelines® is driven by a passion for providing industry with quality user-friendly solutions to keep workers safe and more productive at elevation.

To find your distributor, visit the **Locate-A-Sales-Rep** page on RigidLifelines.com.

Or call us at:

USA or Canada:
800-869-2080 or **610-286-7200**

Mexico: 95-800-270-1080
International inquiries: **800-869-2080**



Model No. RL-PS-50H
Length: 50 ft
Diameter of Rope: 3/16"
Material: Galvanized Cable
Batch #: S20-010
Serial #: 130004869
Date of Mfg: 11/2013

Class B - Self-Retracting Lanyard



Distributed By: B & C Industrial Products, Inc.
1120 Fuller Drive
Garrett, Indiana 43738
PH: 1-888-276-3386
FAX: 1-260-357-0889
EMAIL: sales@bandcip.com

