

If it  
moves  
in a  
hospital...

Distributed by :



PH: 1-888-276-3386 Email:  
sales@bandcip.com

we **move** it!



**MedCaster**<sup>TM</sup>

- Quieter
- Cleaner
- Smoother
- Easier To Roll



# ANTIMICROBIAL CASTERS & WHEELS

## How Does It Work?

The compound used in our antimicrobial wheels, thread guards and forks is designed to suppress the growth of a variety of destructive and odor causing microbes including bacteria, molds, mildew, and fungi. The active ingredients neutralize the ability of microbes to function, grow and reproduce.

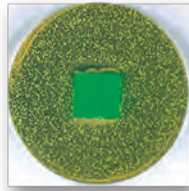

Standard wheel material

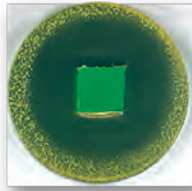

Wheel with antimicrobial compound

## How long does the protection last?

Antimicrobial wheels are engineered to be effective against microbes for the life of the wheel. The agent remains stored in the polymer and is gradually released to the surface of the wheel.

## Will scratches, tread wear or wax buildup diminish the effectiveness?

No. Antimicrobial wheel protection is not a coating on the surface of the wheel, thread guard or fork. It is an integral part of the product. Abrasion, chips or scratches will not impact the effectiveness in any way. Not even wax buildup on the wheel can impair the bacteria fighting performance.

## Does the antimicrobial compound eliminate the need for cleaning?

No. Although antimicrobial compound provides an added level of protection, this does not eliminate the need for normal cleaning practices. They are designed to work in conjunction with

and enhance your ongoing program. Good hygiene practices should always be observed.

## Is the antimicrobial compound safe?

Yes. The active ingredients have undergone extensive laboratory testing and have been proven safe. The active ingredient has a history of hospital use for more than 25 years and is used in a broad range of popular personal care products, such as antimicrobial soap, toothpaste and deodorant. It is registered with the US Environmental Protection Agency (EPA), and products with this material have been approved by the US Food & Drug Administration (FDA), the European Union (EU), the National Sanitation Foundation (NSF) and other regulatory authorities around the world.



MEDICAL



CLEAN INDUSTRIAL



FOOD INDUSTRY



NG Antimicrobial (pages 64-75)



Antimicrobial wheel available for Chrome Hospital (CH) and Stainless Steel (SS) casters.

# ANTISTATIC CASTERS

Electronic equipment can be damaged by the electrostatic discharge of a simple human touch. Damage caused by this discharge is very costly and frustrating to the medical industry. MedCaster antistatic casters and wheels can help minimize the risk of electrostatic discharge. Our antistatic casters and wheels conform to CEN standards with resistance values < 10,000 ohms (measured at 500V DC, with minimum output of 50 V DC at 1,000 ohms resistance).



NA Antistatic



TA Antistatic



CH & SS Antistatic



Rhombus 367 & 364 Antistatic

New Section: See pages 98-103

# CONTENTS

MedCaster Inc. is focused on the manufacturing and supply of casters and wheels to the Medical and Pharmaceutical industries. Our broad line of products and expertise allows us to meet our customer's needs. MedCaster can also design and produce casters and wheels that meet your specific requirements such as custom colors or other specifications. Please contact us toll free at 1-866-462-9700 or email us at info@medcaster.com.

Caster Fitting Guide ..... 4-5  
 Medcaster Model Numbering System..... 6

## MEDCASTER DOUBLE WHEEL CASTERS

Dual Wheel (DW) ..... 7  
 Twin Wheel (TW) ..... 8  
 Grey Tech (GT) ..... 9  
 NeoTeq Chrome Dual (DN)..... 10  
 LevelTeq Dual (DL)..... 11  
 Twin-Med (TM) ..... 12-13  
 Twin-Med Grey (TG) ..... 14-15

## MEDCASTER MULTI-PURPOSE CASTERS

Streamline (SL) ..... 16  
 Optimus (OP) ..... 17  
 NeoTeq (CN)..... 18-19  
 Razer (RZ)..... 20-23  
 Chrome Hospital (CH)..... 24-35  
 Chrome Hospital (CX) ..... 36-41  
 Hospital Covered (CP) ..... 42-45  
 Stainless Steel (SS) 1-1/4" Tread Width ..... 46-51  
 Stainless Steel (SS) 2" Tread Width ..... 52-53  
 Stainless Steel (SX) 1-1/4" Tread Width..... 54-59  
 Autoclave (AC) ..... 60-61

## MEDCASTER NYLON/PLASTIC CASTERS

Nylon/Plastic Caster Introduction ..... 62-63  
 Nylon Next Generation (NG) ..... 64-75  
     Light Grey (NG)  
     Dark Grey (ND)  
     Black (NK)  
 Antimicrobial (NG) ..... 64-75  
 Nylon Plus Stainless (NS) ..... 76-83  
 Non-Magnetic Nylon (NM)..... 84-85  
 Marquee (MP) ..... 86-91  
 Plastic (PG) ..... 92-97

## NEW! MEDCASTER ANTISTATIC CASTERS

Antistatic Introduction ..... 98  
 Chrome Hospital (CH)..... 99  
 Chrome Stainless (SS) ..... 99  
 Nylon Antistatic (NA) ..... 100  
 Rhombus 367 & 364 Antistatic..... 101  
 Twin-Med Antistatic (TA) ..... 102-103

## MEDCASTER HOSPITAL BED CASTERS

Hospital Bed Caster Introduction ..... 104  
 Bed Accessories ..... 105  
 Primacy Twin Wheel (PT)..... 106  
 Med-Ultra (MU) ..... 107  
 Twin Tech Ultra (TU) ..... 108  
 Primacy Single (PS)..... 109  
 Primacy Cover (PC) ..... 110  
 Primacy Cover Precision (PP) ..... 111  
 Med-Bed (MB) ..... 112

## MEDCASTER WHEELS

Wheels ..... 113-116

## RHOMBUS CASTERS

Rhombus Introduction ..... 117  
 Rhombus 367 & 364..... 118-119  
 Bariatric 389..... 120-121  
 390..... 122-123  
 391..... 124-125  
 Nimbus 399..... 126-127

## MEDCASTER SPECIALTY CASTERS & ACCESSORIES

PreVail (PL) ..... 128  
 Bumpers..... 129  
 Caster Sockets and Hardware ..... 130  
 Specialty / Inches to Metric Conversion..... 131

## New Products!

**NEW**



# CASTER FITTINGS GUIDE

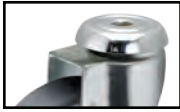

## HOLLOW KINGPIN

Suffix No.	Dimensions	CH	CN	CX	DN	DW	NG	NS	RZ	SS	SX
HK01	1/2" ID	✓		✓	✓	✓	✓	✓		✓	✓
HK02	12mm ID										
HK04	7/16" ID		✓				✓	✓	✓		



## EXPANDING ADAPTER STEMS

Suffix No.	Dimensions	CH	CX	NG	NS	PG
<b>Round Nylon Expanding Adapters</b>						
XRN1	3/4" x 2-1/4"	✓	✓	✓	✓	✓
XRN2	13/16" x 2-1/4"	✓	✓	✓	✓	✓
XRN3	7/8" x 2-1/4" round	✓	✓	✓	✓	✓
XRN4	1" x 2-1/4"	✓	✓	✓	✓	✓



<b>Round Rubber Expanding Adapters</b>						
XRR1	3/4" x 2-1/4"	✓	✓	✓	✓	✓
XRR2	7/8" x 2-1/4"	✓	✓	✓	✓	✓
XRR3	1" x 2-1/4"	✓	✓	✓	✓	✓
XRR4	1-1/8" x 2-1/4"	✓	✓	✓	✓	✓
XRR5	1-1/4" x 2-1/4"	✓	✓	✓	✓	✓
XRR6	1-3/8" x 2-1/4"	✓	✓	✓	✓	✓
XRR7	1-1/2" x 2-1/4"	✓	✓	✓	✓	✓
XRR8	1-5/8" x 2-1/4"	✓	✓	✓	✓	✓



<b>Round Zamac Expanding Adapters</b>						
XRZ1	21/32" x 2-1/4"	✓		✓	✓	✓
XRZ2	3/4" x 2-1/4"	✓		✓	✓	✓
XRZ3	7/8" x 2-1/4"	✓		✓	✓	✓
XRZ4	1" x 2-1/4"	✓		✓	✓	✓
XRZ5	1-3/32" x 2-1/4"	✓		✓	✓	✓

<b>Square Zamac Expanding Adapters</b>						
XSZ1	25/32" x 2-1/4"	✓		✓	✓	✓



## CENTRAL LOCKING STEMS

Suffix No.	Dimensions	Cam degree	MB	MU	PC	PL	PP	PS	PT	TU
CL01	27.8mm x 98mm*	45	✓	✓	✓	✓	✓	✓	✓	✓
CL02	32mm x 54mm	30	✓	✓	✓	✓	✓	✓	✓	✓
CL03	27.8mm x 98mm	30			✓	✓	✓	✓	✓	
CL04	32mm x 54mm	45			✓		✓	✓	✓	

\*MU is 27.8 mm x 96mm.



## SWIVEL TOP PLATES

Suffix No.	Dimensions	AC	CH	CN	CP	CX	DL	DN	DW	GT	NA	NM	MP	NG	NS	PG	RZ	SL	SS	SX	TA	TG	TM
TP01	2-1/2" x 3-5/8"	✓	✓	✓			✓	✓	✓		✓		✓	✓	✓	✓		✓	✓		✓	✓	✓
TP02	1-1/4" x 2-3/8"			✓																			
TP03	4" x 4-1/2"																		✓				
TP04	2.65" x 3"		✓						✓														
TP05	2.36" x 2.36"																	✓					
TP06	2.12" x 2.12"																	✓					
TP07	1-1/2" x 1-1/2"									✓													
TP08	2-3/4" x 2-5/8"									✓													
TP09	2-3/16" x 2-9/16"									✓													
TP10	80mm x 105mm																						
TP11	3" x 2-5/8"								✓						✓						✓	✓	✓
TP12	5" x 5.5"																						
TP13	96mm x 70mm				✓	✓															✓		
TPS1	2-1/2" x 3-5/8"											✓											

<b>AC</b>	Autoclave	<b>OP</b>	Optimus
<b>CH</b>	Chrome Hospital	<b>PC</b>	Primacy Cover
<b>CN</b>	Chrome Neoteq	<b>PD</b>	Plastic Dark Gray
<b>CP</b>	Hospital Covered	<b>PG</b>	Plastic Light Gray]
<b>CX</b>	Chrome Hospital	<b>PP</b>	Primacy Cover Precision
<b>DL</b>	LevelTeq Dual	<b>PS</b>	Primacy Single
<b>DN</b>	Neoteq Dual	<b>PT</b>	Primacy Twin Wheel
<b>DW</b>	Dual wheel	<b>RZ</b>	Razer
<b>GT</b>	Grey Tech	<b>SL</b>	Streamline
<b>MB</b>	Med-Bed	<b>SS</b>	Stainless Steel
<b>OP</b>	Optimus	<b>SX</b>	Stainless Hospital
<b>MP</b>	Marquee	<b>TA</b>	Twin-Med Antistatic
<b>MU</b>	Med-Ultra	<b>TG</b>	Twin-Med Grey
<b>NA</b>	Nylon Antistatic	<b>TM</b>	Twin-Med Ultra
<b>ND</b>	Nylon Dark Grey	<b>TU</b>	Twin-Tech Ultra
<b>NG</b>	Nylon Light Grey	<b>TW</b>	Twin Wheel
<b>NK</b>	Nylon Black	<b>WO</b>	Misc. Wheel Only
<b>NM</b>	Nylon Non-Magnetic		
<b>NS</b>	Nylon Plus Stainless		

Continue next page

# CASTER FITTINGS GUIDE



## ROUND STEMS

Suffix No.	Dimensions	CH	MB	MU	NG	PC	PG	PP	PS	PT	SS	TU
RS01	22mm x 45mm	✓			✓		✓				✓	
RS02	25.4mm x 45mm	✓			✓		✓					
RS03	27.8mm x 45mm	✓	✓	✓	✓	✓	✓	✓	✓	✓		✓
RS04	20.5mm x 45mm	✓			✓		✓					
RS05	32mm x 45mm	✓	✓	✓	✓	✓	✓	✓	✓	✓		✓



## SQUARE STEMS

Suffix No.	Dimensions	AC	CH	NG	PG
SQ01	3/4" x 2" no holes		✓	✓	✓
SQ02	1" x 1.75" 3 holes			✓	✓
SQ03	.850" x 2.2" grip ring		✓	✓	✓
SQ05	7/8" x 3-1/2" square	✓			



## GRIP RING STEMS

Suffix No.	Dimensions	AC	CH	CN	GT	MP	NA	NG	NS	OP	PG	RZ	SL	SS	SX	TW
GR01	7/16" x 7/8" round	✓		✓	✓	✓	✓	✓		✓		✓	✓			✓
GR02	7/16" x 1-7/16" round	✓	✓	✓	✓	✓	✓	✓		✓	✓	✓	✓	✓		✓
GRS2	7/16" x 1-7/16" round*													✓	✓	
GR03	3/8" x 7/8" round				✓							✓				
GR04	5/8" x 1-5/8" round							✓								
GR05	3/4" x 1-5/8" round							✓								
GR06	7/8" x 2" round							✓								
GR07	1" x 1-7/8" round							✓								
GR08	7/16" x 1-29/32" round					✓		✓			✓					
GR09	.845" x 2-3/16" round		✓	✓			✓	✓	✓		✓		✓			
GR10	7/16" x 1-3/8" round			✓				✓								
GR11	.845" x 2-3/16" round*		✓					✓		✓				✓		
GR12	7/16" x 1-15/16" round							✓								



## THREADED STEMS

Suffix No.	Dimensions	CH	CN	CP	CX	DN	GT	NA	NG	NM	NS	MP	OP	PG	RZ	SL	SS	SX	TA	TG	TM	TW
TS01	1/2"-13NC x 3/4"	✓							✓					✓								
TS02	1/2"-13NC x 1"	✓		✓	✓	✓	✓	✓	✓			✓		✓		✓			✓		✓	✓
TSS2	1/2"-13NC x 1"***									✓												
TS03	1/2"-13NC x 1-1/2"	✓			✓		✓	✓	✓			✓		✓					✓			✓
TS04	1/2"-13NC x 2"	✓												✓								
TS05	7/16"-14NC x 1-3/4"								✓													
TS06	3/8"-16NC x 1"		✓				✓					✓			✓							✓
TS07	M12 x 1"	✓							✓										✓	✓	✓	
TS11	1/2"-13NC x 3/4"*																					
TS12	1/2"-13NC x 1"*										✓						✓	✓				
TS13	1/2"-13NC x 1-1/2"*										✓						✓	✓				
TS14	1/2"-13NC x 2"*																✓	✓				
TS15	M10 x 19/32"														✓							✓
TS16	M12 x 25/32"																		✓	✓		
TS17	M14 x 7/8"																					
TS18	M16 x 25/32"																		✓	✓	✓	
TS19	M12 x 1-1/8"																					
TS20	M10 x 43/64"																					
TS21	M12 x 60mm	✓							✓													
TS21S	M12 x 60mm*										✓						✓	✓				
TS22	1/2"-13NC x 2-11/16"	✓							✓													
TS22S	1/2"-13NC x 2-11/16"*										✓						✓	✓				
TS23	M12 X 15mm																				✓	
TS24	3/8"-16NC x 3/4"						✓															
TS25	3/8"-16NC x 1-1/2"														✓							
TS26	M12-1.75" x 2-1/2"																				✓	
TS27	3/8"-16 x 1-3/4"																					

\*Stainless

\*\*316 Stainless

# MEDCASTER MODEL NUMBERING SYSTEM

Below example is a Nylon Light Grey (NG) caster that has a 5" diameter QuickStart wheel with a dark grey tread, thread guard and Precision Ball bearing. The tread width is 1-1/4" wide. The fork type is swivel. The fitting type is threaded stem (1/2"-13NC x 1-1/2").

**N G - 0 5 Q D P - 1 2 5 - S W - T S 0 3**

<b>AC</b> Autoclave	<b>OP</b> Optimus	<b>Wheel Type</b>	<b>PS</b> Polyurethane Solid	<b>Bearing Type</b>	<b>Fork Type</b>	<b>Fitting Code</b>
<b>CH</b> Chrome Hospital	<b>PC</b> Primacy Cover	<b>AM</b> Anti-Microbial TPR	<b>PW</b> White Polyurethane	<b>A</b> Annular	<b>DL</b> Directional Lock	See page 4-5 for stem codes
<b>CN</b> Chrome Neoteq	<b>PD</b> Plastic Dark Gray	<b>AP</b> Anti-static Polyurethane	<b>PY</b> Polyurethane TPU	<b>B</b> Ball	<b>DT</b> Direction/Total Comb.	<b>Fitting Type</b>
<b>CP</b> Hospital Covered	<b>PG</b> Plastic Light Gray]	<b>AR</b> Anti-static Rubber	<b>QB</b> QuickStart (dark grey tread with black thread guard)	<b>D</b> Delrin	<b>FB</b> Face Brake	<b>GR</b> Grip Ring
<b>CX</b> Chrome Hospital	<b>PP</b> Primacy Cover Precision	<b>AT</b> Anti-Static TPR	<b>QD</b> QuickStart (dark grey tread and thread guard)	<b>N</b> Plain, Nylon	<b>RB</b> Rigid Brake	<b>HK</b> Hollow Kingpin
<b>DL</b> LevelTeq Dual	<b>PS</b> Primacy Single	<b>EP</b> MedEagle	<b>QL</b> QuickStart (light grey tread and thread guard)	<b>O</b> Plain Bore	<b>RG</b> Rigid	<b>OS</b> Octagon Stem
<b>DN</b> Neoteq Dual	<b>PT</b> Primacy Twin Wheel	<b>HR</b> High Temp Rubber	<b>RM</b> Rubber on Metal	<b>P</b> Precision	<b>SB</b> Side Brake	<b>RS</b> Round Stem
<b>DW</b> Dual wheel	<b>RZ</b> Razer	<b>GR</b> Grey rubber	<b>RP</b> Rubber on Plastic	<b>R</b> Roller	<b>SW</b> Swivel	<b>SP</b> Special
<b>GT</b> Grey Tech	<b>SL</b> Streamline	<b>CR</b> Conductive Rubber	<b>RR</b> Rubber on Rubber	<b>S</b> Stainless Roller	<b>TB</b> Top Brake	<b>SQ</b> Square Stem
<b>MB</b> Med-Bed	<b>SS</b> Stainless Steel	<b>NR</b> Neoprene Rubber	<b>TP</b> Thermoplastic Rubber	<b>X</b> Stainless Precision	<b>TL</b> Total Lock	<b>CL</b> System Stem
<b>OP</b> Optimus	<b>SX</b> Stainless Hospital	<b>HS</b> Hytrel on PP				<b>TP</b> Top Plate
<b>MP</b> Marquee	<b>TA</b> Twin-Med Antistatic	<b>NY</b> Nylon		<b>Tread Width</b>		<b>TS</b> Threaded Stem
<b>MU</b> Med-Ultra	<b>TG</b> Twin-Med Grey	<b>PB</b> Polyurethane Black		<b>025</b> .25		<b>XR</b> Expanding Round
<b>NA</b> Nylon Antistatic	<b>TM</b> Twin-Med	<b>PH</b> Phenolic		<b>050</b> .50		<b>XS</b> Expanding Square
<b>ND</b> Nylon Dark Grey	<b>TU</b> Twin-Tech Ultra	<b>PP</b> Polyolefin		<b>075</b> .75		
<b>NG</b> Nylon Light Grey	<b>TW</b> Twin Wheel	<b>PR</b> Performa Rubber		<b>100</b> 1		
<b>NK</b> Nylon Black	<b>WO</b> Misc. Wheel Only			<b>125</b> 1.25		
<b>NM</b> Nylon Non-Magnetic				<b>150</b> 1.5		
<b>NS</b> Nylon Plus Stainless				<b>200</b> 2		

Wheel Diameter			
<b>01</b>	1	<b>06</b>	6
<b>02</b>	2	<b>07</b>	7
<b>03</b>	3	<b>08</b>	8
<b>35</b>	3.5	<b>24</b>	24
<b>04</b>	4		
<b>05</b>	5		

## FORK/RIG NUMBERING SYSTEM

Fork/Rig models are similar to caster models except there is no wheel code. Below is an example of a fork/rig only model for a 5" diameter by 1-1/4" tread width wheel. The fork type is swivel. The fitting type is threaded stem (1/2"-13NC x 1-1/2").

**NG-0 5 - 1 2 5 - S W - T S 0 3**

## WHEEL NUMBERING SYSTEM

Wheel replacement models are similar to caster models except the last 2 digits. Below example is a wheel for a Nylon Light Grey (NG) caster that has a 5" diameter QuickStart wheel with a dark grey tread, thread guard and Precision Ball Bearing. The tread width is 1-1/4" wide. The axle is 5/16".

**NG-0 5 Q D P - 1 2 5 - 0 5**

<b>04</b>	1/4" axle
<b>05</b>	5/16" axle
<b>06</b>	3/8" axle
<b>08</b>	1/2" axle
<b>10</b>	5/8" axle
<b>12</b>	3/4" axle

# DUAL WHEEL (DW) CASTERS

TOP PLATE/  
HOLLOW KINGPIN MODELS  
FREE SWIVEL • TOTAL LOCK



**APPLICATIONS**

- Patient Lifts
- Medical Equipment
- Computer Equipment

**FEATURES**

- Low profile, easy swiveling and smooth rolling.
- Durable zinc plated finish
- Non-marking grey TPR rubber tread
- Foot activated total lock brake
- Integrated thread guards
- Dual ball bearing raceway
- Precision Bearings in Wheels

Our Dual wheel casters provide a low profile, easy swiveling and smooth rolling.

## TOP PLATE SWIVEL MODELS

Wheel Diameter (Inches)	Tread Width (Inches)	Wheel Description	Capacity (Lbs)	Load Height Inches (mm)	Swivel Radius Inches (mm)	Wheel Bearing	Model Number
2	1-21/32	Grey Rubber	200	2-29/32" (74)	2-1/8 (54)	Precision	DW-02GRP-100-SW-___
3	2	Thermoplastic Rubber	220	4-1/16" (103)	2-23/32 (69)	Precision	DW-03TPP-100-SW-___



## TOP PLATE SWIVEL TOTAL LOCK MODELS

(LOCKS WHEEL AND SWIVEL)

Wheel Diameter (Inches)	Tread Width (Inches)	Wheel Description	Capacity (Lbs)	Load Height Inches (mm)	Swivel Radius Inches (mm)	Wheel Bearing	Model Number
2	1-21/32	Grey Rubber	200	2-29/32" (74)	3-3/16 (81)	Precision	DW-02GRP-100-TL-___
3	2	Thermoplastic Rubber	220	4-1/16" (103)	3-1/2 (89)	Precision	DW-03TPP-100-TL-___



## HOLLOW KINGPIN MODELS

Wheel Diameter (Inches)	Tread Width (Inches)	Wheel Description	Capacity (Lbs)	Load Height Inches (mm)	Swivel Radius Inches (mm)	Wheel Bearing	Model Number
2	1-21/32	Grey Rubber	200	2-27/32" (72)	2-1/8 (54)	Precision	DW-02GRP-100-SW-___
3	2	Thermoplastic Rubber	220	3-15/16" (100)	2-23/32 (69)	Precision	DW-03TPP-100-SW-___



## HOLLOW KINGPIN TOTAL LOCK MODELS

(LOCKS WHEEL AND SWIVEL)

Wheel Diameter (Inches)	Tread Width (Inches)	Wheel Description	Capacity (Lbs)	Load Height Inches (mm)	Swivel Radius Inches (mm)	Wheel Bearing	Model Number
2	1-21/32	Grey Rubber	200	2-27/32" (72)	3-3/16 (81)	Precision	DW-02GRP-100-TL-___
3	2	Thermoplastic Rubber	220	3-15/16" (100)	3-1/2 (89)	Precision	DW-03TPP-100-TL-___



## TOP PLATE FITTING

Swivel Top Plate Pattern

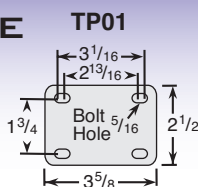

3" models only

## TP04

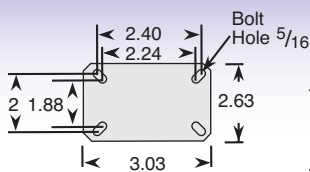

2" models only for TP04 and TP11

## TP11

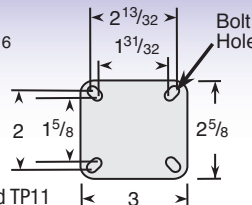

## HOLLOW RIVET

Caster is provided assembled. Change HK01 code to HKU1 for unassembled. 1/2" I.D.

# TWIN WHEEL (TW) CASTERS

GRIP RING & THREADED STEM MODELS  
FREE SWIVEL • BRAKE



**APPLICATIONS**

- Medical Carts
- Furniture
- Concentrator Bases
- Utility Carts

**FEATURES**

- Durable Nylon Construction
- Riveted Axle
- Smooth Finish Design
- Custom colors available

Contemporary design features strong nylon construction.

## GRIP RING/THREADED STEM MODELS

Wheel Diameter (Inches)	Tread Width (Inches)	Wheel Description	Capacity (Lbs)	Load Height (Inches)	Swivel Radius (Inches)	Wheel Bearing	Model Number
2	1-7/8	Nylon Black	90	2-29/64" (62)	2" (51)	Plain	TW-02NYO-200-SW-
3	2-1/4	Thermoplastic Rubber	165	3-1/4" (83)	2-1/2" (64)	Plain	TW-03TPO-200-SW-
3	2-1/4	Nylon Black	165	3-1/4" (83)	2-1/2" (64)	Plain	TW-03NYO-200-SW-
4	2-3/8	Polyurethane Black	175	4-3/8" (111)	3-5/8" (92)	Plain	TW-04PBO-200-SW-
4	2-3/8	Nylon Black	175	4-3/8" (111)	3-5/8" (92)	Plain	TW-04NYO-200-SW-
5	2-3/8	Polyurethane Black	180	5-7/16" (138)	4-1/2" (114)	Plain	TW-05PBO-200-SW-
5	2-3/8	Nylon Black	180	5-7/16" (138)	4-1/2" (114)	Plain	TW-05NYO-200-SW-



## GRIP RING/THREADED STEM BRAKE MODELS

Wheel Diameter (Inches)	Tread Width (Inches)	Wheel Description	Capacity (Lbs)	Load Height (Inches)	Swivel Radius (Inches)	Wheel Bearing	Model Number
2	1-7/8	Nylon Black	90	2-29/64" (62)	2" (51)	Plain	TW-02NYO-200-TB-
3	2-1/4	Thermoplastic Rubber	165	3-1/4" (83)	2-1/2" (64)	Plain	TW-03TPO-200-TB-
3	2-1/4	Nylon Black	165	3-1/4" (83)	2-1/2" (64)	Plain	TW-03NYO-200-TB-
4	2-3/8	Polyurethane Black	175	4-3/8" (111)	3-5/8" (92)	Plain	TW-04PBO-200-TB-
4	2-3/8	Nylon Black	175	4-3/8" (111)	3-5/8" (92)	Plain	TW-04NYO-200-TB-
5	2-3/8	Polyurethane Black	180	5-7/16" (138)	4-1/2" (114)	Plain	TW-05PBO-200-TB-
5	2-3/8	Nylon Black	180	5-7/16" (138)	4-1/2" (114)	Plain	TW-05NYO-200-TB-



Top Plate models are available in some of the above sizes, please consult factory.

Specify Grip Ring Stem (GR) or Threaded Stem (TS) code, see fittings below for dimensions:

### GRIP RING STEM FITTINGS

See fittings page for more options.



### THREADED STEM FITTINGS

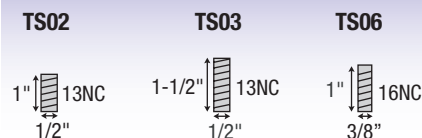



# GREY TECH (GT) CASTERS

GRIP RING STEM, THREADED  
STEM & SWIVEL PLATE MODELS  
FREE SWIVEL • BRAKE

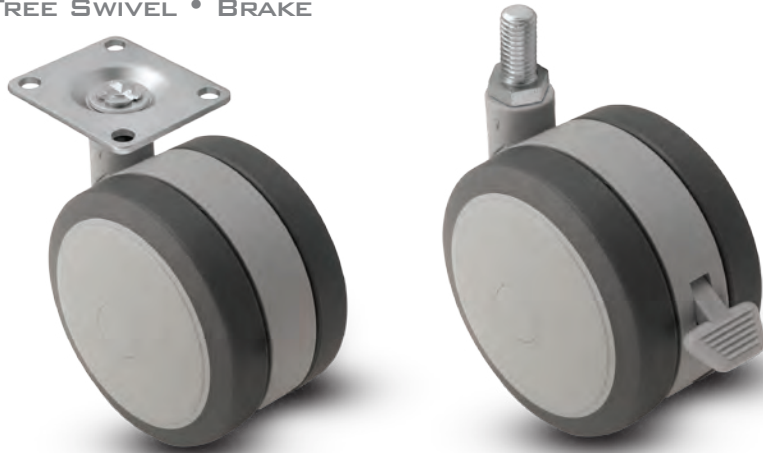

**APPLICATIONS**

- Electronic Equipment
- Medical Equipment
- Audio/Visual Equipment
- Furniture

**FEATURES**

- Soft 70-75/A durometer tread constructed of high-tech thermoplastic elastomer
- High load ratings
- Quite mobility
- Riveted axle for positive wheel retention

Soft tread twin wheel caster for quiet mobility

## GRIP RING/THREADED STEM MODELS

Wheel Diameter Inches (mm)	Tread Width (Inches)	Wheel Description	Capacity (Lbs)	Load Height Inches (mm)	Swivel Radius Inches (mm)	Wheel Bearing	Model Number
2 (50)	2-1/4	Thermoplastic Rubber	75	2-1/4" (57)	1-13/16" (46)	Plain	GT-02TPO-200-SW-___
3 (75)	2-1/4	Thermoplastic Rubber	165	3-1/4" (83)	2-1/2" (64)	Plain	GT-03TPO-200-SW-___
4 (100)	2-1/4	Thermoplastic Rubber	225	4-3/8" (111)	3-5/8" (92)	Plain	GT-04TPO-200-SW-___
5 (125)	2-1/4	Thermoplastic Rubber	225	5-7/16" (138)	4-1/2" (114)	Plain	GT-05TPO-200-SW-___

## GRIP RING/THREADED STEM BRAKE MODELS

2 (50)	2-1/4	Thermoplastic Rubber	75	2-1/4" (57)	2-3/8" (60)	Plain	GT-02TPO-200-TB-___
3 (75)	2-1/4	Thermoplastic Rubber	165	3-1/4" (83)	3-3/16" (81)	Plain	GT-03TPO-200-TB-___
4 (100)	2-1/4	Thermoplastic Rubber	225	4-3/8" (111)	4-1/2" (114)	Plain	GT-04TPO-200-TB-___
5 (125)	2-1/4	Thermoplastic Rubber	225	5-7/16" (138)	5-1/8" (130)	Plain	GT-05TPO-200-TB-___

## TOP PLATE MODELS

2 (50)	2-1/4	Thermoplastic Rubber	75	2-3/8" (60)	1-13/16" (46)	Plain	GT-02TPO-200-SW-___
3 (75)	2-1/4	Thermoplastic Rubber	165	3-1/2" (89)	2-1/2" (64)	Plain	GT-03TPO-200-SW-___
4 (100)	2-1/4	Thermoplastic Rubber	225	4-5/8" (117)	3-5/8" (92)	Plain	GT-04TPO-200-SW-___
5 (125)	2-1/4	Thermoplastic Rubber	225	5-5/8" (143)	4-1/2" (114)	Plain	GT-05TPO-200-SW-___

## TOP PLATE BRAKE MODELS

2 (50)	2-1/4	Thermoplastic Rubber	75	2-3/8" (60)	2-3/8" (60)	Plain	GT-02TPO-200-TB-___
3 (75)	2-1/4	Thermoplastic Rubber	165	3-1/2" (89)	3-3/16" (81)	Plain	GT-03TPO-200-TB-___
4 (100)	2-1/4	Thermoplastic Rubber	225	4-5/8" (117)	4-1/2" (114)	Plain	GT-04TPO-200-TB-___
5 (125)	2-1/4	Thermoplastic Rubber	225	5-5/8" (143)	5-1/8" (130)	Plain	GT-05TPO-200-TB-___



Specify fitting code, see fittings below for dimensions:

### GRIP RING STEM FITTINGS

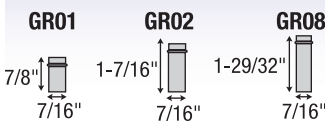

### THREADED STEM FITTINGS

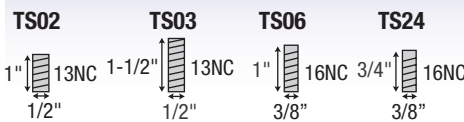

### TOP PLATES

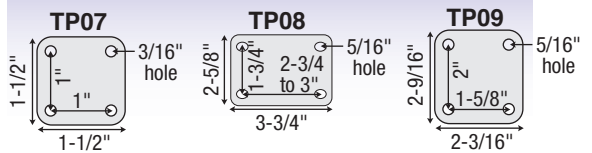

See fittings page for more options.

# NEOTEQ DUAL (DN) COMFORT ROLL

TOP PLATE MODELS  
FREE SWIVEL • BRAKE



**APPLICATIONS**

- Laboratory Equipment
- IV Stands
- Mobile Computer Stands
- Medical Equipment

**FEATURES**

- Bright Chrome Finish
- Dual wheels maneuver easily
- Matching Chrome Thread Guards for wheels
- Non-Marking Soft-Neoprene Rubber wheels
- Dual Ball Swivel Raceways for added strength
- Precision ball bearings in wheels for easier rollability
- Upper dustcap to prevent dirt and dust build-up

Dual Wheel Chrome NeoTeq series are designed to provide your equipment with a smooth and quiet roll with easy turning and maneuverability.

## SWIVEL TOP PLATE MODELS



Wheel Diameter (Inches)	Tread Width Inches (mjm)	Wheel Description	Capacity (Lbs)	Load Height Inches (mm)	Swivel Radius Inches (mm)	Wheel Bearing	Model Number
2	1" (25)	Neoprene Rubber	250	3-3/8" (86)	2-3/8 (60)	Precision Ball	DN-02NRP-100-SW-TP01
2-1/2	1" (25)	Neoprene Rubber	300	3-7/8 (98)	2-1/2" (63)	Precision Ball	DN-25NRP-100-SW-TP01

## RIGID TOP PLATE MODELS



Wheel Diameter (Inches)	Tread Width Inches (mjm)	Wheel Description	Capacity (Lbs)	Load Height Inches (mm)	Swivel Radius Inches (mm)	Wheel Bearing	Model Number
2	1" (25)	Neoprene Rubber	250	3-3/8" (86)	N/A	Precision Ball	DN-02NRP-100-RG-TP01
2-1/2	1" (25)	Neoprene Rubber	300	3-7/8 (98)	N/A	Precision Ball	DN-25NRP-100-RG-TP01

## THREADED STEM MODELS



Wheel Diameter (Inches)	Tread Width Inches (mjm)	Wheel Description	Capacity (Lbs)	Load Height Inches (mm)	Swivel Radius Inches (mm)	Wheel Bearing	Model Number
2	1" (25)	Neoprene Rubber	250	3-1/4" (83)	2-3/8 (60)	Precision Ball	DN-02NRP-100-SW-TS02
2-1/2	1" (25)	Neoprene Rubber	300	3-3/4 (95)	2-1/2" (63)	Precision Ball	DN-25NRP-100-SW-TS02

## HOLLOW KINGPIN MODELS



Wheel Diameter (Inches)	Tread Width Inches (mjm)	Wheel Description	Capacity (Lbs)	Load Height Inches (mm)	Swivel Radius Inches (mm)	Wheel Bearing	Model Number
2	1" (25)	Neoprene Rubber	250	3-1/4" (83)	2-3/8 (60)	Precision Ball	DN-02NRP-100-SW-HK01
2-1/2	1" (25)	Neoprene Rubber	300	3-3/4 (95)	2-1/2" (63)	Precision Ball	DN-25NRP-100-SW-HK01

### FITTINGS

See fittings page for more options.

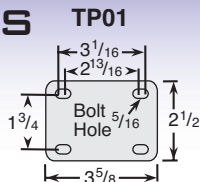

### TS02



### HOLLOW RIVET

Caster is provided assembled. Change HK01 code to HKU1 for unassembled. 1/2" I.D.

# LEVELTEQ DUAL (DL) COMFORT ROLL

TOP PLATE MODELS  
FREE SWIVEL

**NEW**

**APPLICATIONS**

- Laboratory Equipment
- Mobile Computer Stands
- Medical Equipment

**FEATURES**

- Bright Chrome Finish
- Dual wheels maneuver easily
- Matching Chrome Thread Guards for wheels
- Non-Marking Soft-Neoprene Rubber wheels
- Precision ball bearings in wheels for easier rollability
- Upper dustcap to prevent dirt and dust build-up



Dual Wheel LevelTeq series are designed to provide your equipment with a smooth and quiet roll with easy turning and maneuverability with the added ability to level your equipment. Capacities up to 300 lbs.

## SWIVEL TOP PLATE MODELS



Wheel Diameter (Inches)	Tread Width Inches (mm)	Wheel Description	Capacity (lbs)	Load Height Inches (mm)	Swivel Radius Inches (mm)	Wheel Bearing	Model Number
2"	1 (25)	Neoprene Rubber	250	3-3/8" (86)	2-3/8" (60)	Precision Ball	DL-02NRP100-SW-TP01
2.5"	1 (25)	Neoprene Rubber	300	3-7/8" (98)	2-1/2" (64)	Precision Ball	DL-25NRP100-SW-TP01

### FITTINGS TP01

See fittings page for more options.

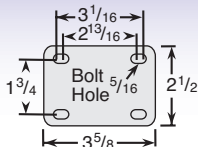

# TWIN-MED (TM)

## THREADED STEM MODELS

FREE SWIVEL • BRAKE



### APPLICATIONS

- Nursing Home Beds
- Medical Carts
- Diagnostic Equipment
- Electronic Equipment
- Patient Aids
- Patient Lifts

### FEATURES

- Ball bearing swivel raceway on 3" and 4" models
- 5" models feature a sealed precision ball bearing in the swivel raceway
- Wheels have easy rollability
- Our design protects axle/bearing areas from hair/water
- Total Lock models lock both the wheel and swivel
- Directional Lock (locks swivel) models are available. Please consult factory.

Special colors available. Consult factory.

New Flexthane softer urethane tread available. To order change PYP to FYP in wheel code (Example: TM-03FYP-281-SW-TS02).



### FREE SWIVEL MODELS

Wheel Diameter (Inches)	Tread Width Inches (mm)	Wheel Description	Capacity (lbs)	Load Height Inches (mm)	Swivel Radius Inches (mm)	Wheel Bearing	Model Number
3	2-5/16" (59)	Polyurethane Gray	165	3-3/4" (95)	2-7/16" (65)	Plain	TM-03PY0-281-SW-____
3	2-5/16" (59)	Polyurethane Gray	165	3-3/4" (95)	2-7/16" (65)	Precision	TM-03PYP-281-SW-____
4	2-39/64" (66)	Polyurethane Gray	220	5" (127)	3-1/8" (79)	Plain	TM-04PY0-281-SW-____
4	2-39/64" (66)	Polyurethane Gray	220	5" (127)	3-1/8" (79)	Precision	TM-04PYP-281-SW-____
4	2-39/64" (66)	Thermoplastic TPP	220	5" (127)	3-1/8" (79)	Plain	TM-04TPO-281-SW-____
5	3" (76)	Polyurethane Gray	246	6" (152)	4" (102)	Precision	TM-05PYP-281-SW-____
5	3" (76)	Thermoplastic TPP	246	6" (152)	4" (102)	Precision	TM-05TPP-281-SW-____

Total Lock (Grey Pedal)



### TOTAL LOCK MODELS (LOCKS WHEEL AND SWIVEL)

Wheel Diameter (Inches)	Tread Width Inches (mm)	Wheel Description	Capacity (lbs)	Load Height Inches (mm)	Swivel Radius Inches (mm)	Wheel Bearing	Model Number
3	2-5/16" (59)	Polyurethane Gray	165	3-3/4" (95)	2-7/16" (65)	Plain	TM-03PY0-281-TL-____
3	2-5/16" (59)	Polyurethane Gray	165	3-3/4" (95)	2-7/16" (65)	Precision	TM-03PYP-281-TL-____
4	2-39/64" (66)	Polyurethane Gray	220	5" (127)	3-1/8" (79)	Plain	TM-04PY0-281-TL-____
4	2-39/64" (66)	Polyurethane Gray	220	5" (127)	3-1/8" (79)	Precision	TM-04PYP-281-TL-____
4	2-39/64" (66)	Thermoplastic TPP	220	5" (127)	3-1/8" (79)	Plain	TM-04TPO-281-TL-____
5	3" (76)	Polyurethane Gray	246	6" (152)	4" (102)	Precision	TM-05PYP-281-TL-____
5	3" (76)	Thermoplastic TPP	246	6" (152)	4" (102)	Precision	TM-05TPP-281-TL-____

### THREADED STEM FITTINGS

See fittings page for more options.

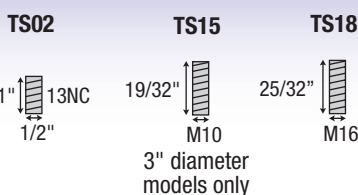

Specify Threaded Stem (TS) code, see fittings below for dimensions:

# TWIN-MED (TM)

## TOP PLATE MODELS

FREE SWIVEL • BRAKE



### APPLICATIONS

- Nursing Home Beds
- Medical Carts
- Diagnostic Equipment
- Electronic Equipment
- Patient Aids
- Patient Lifts

### FEATURES

- Ball bearing swivel raceway on 3" and 4" models
- 5" models feature a sealed precision ball bearing in the swivel raceway
- Wheels have easy rollability
- Our design protects axle/bearing areas from hair/water
- Total Lock models lock both the wheel and swivel
- Directional Lock (locks swivel) models are available. Please consult factory.

Special colors available. Consult factory.

New Flexthane softer urethane tread available. To order change PYP to FYP in wheel code (Example: TM-03FYP-281-SW-TS02).



## FREE SWIVEL MODELS

Wheel Diameter (Inches)	Tread Width Inches (mm)	Wheel Description	Capacity (Lbs)	Load Height Inches (mm)	Swivel Radius Inches (mm)	Wheel Bearing	Model Number
3	2-5/16 (59)	Polyurethane Gray	165	4-1/8" (105)	2-5/16" (59)	Plain	TM-03PYO-281-SW-____
3	2-5/16 (59)	Polyurethane Gray	165	4-1/8" (105)	2-5/16" (59)	Precision	TM-03PYP-281-SW-____
4	2-39/64" (66)	Polyurethane Gray	220	5-3/8" (137)	3-1/8" (79)	Plain	TM-04PYO-281-SW-____
4	2-39/64" (66)	Polyurethane Gray	220	5-3/8" (137)	3-1/8" (79)	Precision	TM-04PYP-281-SW-____
4	2-39/64" (66)	Thermoplastic TPP	220	5-3/8" (137)	3-1/8" (79)	Plain	TM-04TPO-281-SW-____
5	3" (76)	Polyurethane Gray	246	6-3/8" (162)	4" (102)	Precision	TM-05PYP-281-SW-____
5	3" (76)	Thermoplastic TPP	246	6-3/8" (162)	4" (102)	Precision	TM-05TPP-281-SW-____



Total Lock (Grey Pedal)

## TOTAL LOCK MODELS (LOCKS WHEEL AND SWIVEL)

Wheel Diameter (Inches)	Tread Width Inches (mm)	Wheel Description	Capacity (Lbs)	Load Height Inches (mm)	Swivel Radius Inches (mm)	Wheel Bearing	Model Number
3	2-5/16 (59)	Polyurethane Gray	165	4-1/8" (105)	2-5/16" (59)	Plain	TM-03PYO-281-TL-____
3	2-5/16 (59)	Polyurethane Gray	165	4-1/8" (105)	2-5/16" (59)	Precision	TM-03PYP-281-TL-____
4	2-39/64" (66)	Polyurethane Gray	220	5-3/8" (137)	3-1/8" (79)	Plain	TM-04PYO-281-TL-____
4	2-39/64" (66)	Polyurethane Gray	220	5-3/8" (137)	3-1/8" (79)	Precision	TM-04PYP-281-TL-____
4	2-39/64" (66)	Thermoplastic TPP	220	5-3/8" (137)	3-1/8" (79)	Plain	TM-04TPO-281-TL-____
5	3" (76)	Polyurethane Gray	246	6-3/8" (162)	4" (102)	Precision	TM-05PYP-281-TL-____
5	3" (76)	Thermoplastic TPP	246	6-3/8" (162)	4" (102)	Precision	TM-05TPP-281-TL-____

## TOP PLATE FITTINGS

See fittings page for more options.

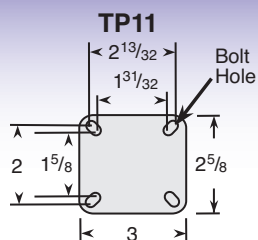
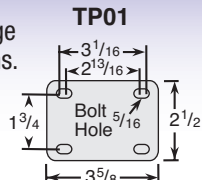

Direction Lock (Black Pedal)



\*Change "TL" to "DL" for Direction Lock models. Available on all precision bearing models. TM-04PYP-281-DL-TP01 shown.

# TWIN-MED GREY (TG)

## THREADED STEM MODELS

FREE SWIVEL • BRAKE

**NEW**



### APPLICATIONS

- Nursing Home Beds
- Medical Carts
- Diagnostic Equipment
- Electronic Equipment
- Patient Aids
- Patient Lifts

### FEATURES

- New Twin-Med Grey come with our new rounded pedal design and bottom undercover
- Wheels feature precision ball bearings for quieter smoother operation
- Softer quieter TPR tread design
- Double ball bearing located in the swivel raceway on 3" and 4" models
- 5" models feature a sealed precision bearing in the swivel raceway
- Wheels have easy rollability
- Designed to protect axle/bearing areas from hair/water
- Total Lock models lock both the wheel and swivel
- Directional Lock (locks swivel) models are available. Please consult factory.



Antistatic available, see page 102-103.

Special colors available. Consult factory.



Undercover shield for ultimate protection.



### FREE SWIVEL MODELS

Wheel Diameter (Inches)	Tread Width Inches (mm)	Wheel Description	Capacity (Lbs)	Load Height Inches (mm)	Swivel Radius Inches (mm)	Wheel Bearing	Model Number
4	2-39/64" (66)	Thermoplastic Rubber	220	5" (127)	3-1/8" (79)	Precision Ball	TG-04TPP-281-SW-____
5	3" (76)	Thermoplastic Rubber	246	6" (152)	4" (102)	Precision Ball	TG-05TPP-281-SW-____

### TOTAL LOCK MODELS (LOCKS WHEEL AND SWIVEL)

Wheel Diameter (Inches)	Tread Width Inches (mm)	Wheel Description	Capacity (Lbs)	Load Height Inches (mm)	Swivel Radius Inches (mm)	Wheel Bearing	Model Number
4	2-39/64" (66)	Thermoplastic Rubber	220	5" (127)	3-1/8" (79)	Precision Ball	TG-04TPP-281-TL-____
5	3" (76)	Thermoplastic Rubber	246	6" (152)	4" (102)	Precision Ball	TG-05TPP-281-TL-____



### THREADED STEM FITTINGS

See fittings page for more options.

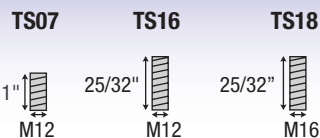

Specify Threaded Stem (TS) code, see fittings below for dimensions:

# TWIN-MED GREY (TG)

## TOP PLATE MODELS

FREE SWIVEL • BRAKE

**NEW**



### APPLICATIONS

- Nursing Home Beds
- Medical Carts
- Diagnostic Equipment
- Electronic Equipment
- Patient Aids
- Patient Lifts

### FEATURES

- New Twin-Med Grey come with our new rounded pedal design and bottom undercover
- Wheels feature precision ball bearings for quieter smoother operation
- 5" now comes with a sealed precision bearing in the swivel raceway
- Softer quieter TPR tread design
- Double ball bearing located in the swivel raceway
- Wheels have easy rollability
- Designed to protect axle/bearing areas from hair/water
- Total Lock models lock both the wheel and swivel
- Directional Lock (locks swivel) models are available. Please consult factory.



Antistatic available, see page 102-103.

Special colors available. Consult factory.



Undercover shield for ultimate protection.



## FREE SWIVEL MODELS

Wheel Diameter (Inches)	Tread Width Inches (mm)	Wheel Description	Capacity (Lbs)	Load Height Inches (mm)	Swivel Radius Inches (mm)	Wheel Bearing	Model Number
4	2-39/64" (66)	Thermoplastic Rubber	220	5-3/8" (137)	3-1/8" (79)	Precision Ball	TG-04TPP-281-SW-____
5	3" (76)	Thermoplastic Rubber	246	6-3/8" (162)	4" (102)	Precision Ball	TG-05TPP-281-SW-____



## TOTAL LOCK MODELS (LOCKS WHEEL AND SWIVEL)

Wheel Diameter (Inches)	Tread Width Inches (mm)	Wheel Description	Capacity (Lbs)	Load Height Inches (mm)	Swivel Radius Inches (mm)	Wheel Bearing	Model Number
4	2-39/64" (66)	Thermoplastic Rubber	220	5-3/8" (137)	3-1/8" (79)	Precision Ball	TG-04TPP-281-TL-____
5	3" (76)	Thermoplastic Rubber	246	6-3/8" (162)	4" (102)	Precision Ball	TG-05TPP-281-TL-____

## TOP PLATE FITTINGS

See fittings page for more options.

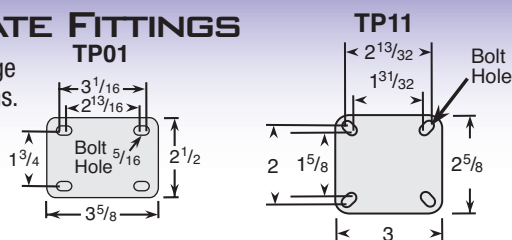

\*Change "TL" to "DL" for Direction Lock models. Available on all precision bearing models. TG-04TPP-281-DL-TP01 shown.

# STREAMLINE (SL)

TOP PLATE/GRIP RING/  
FREE SWIVEL • TOTAL LOCK



## APPLICATIONS

- Laboratory Equipment
- Mobile Computer Stands
- Medical Equipment
- Diagnostic equipment
- Hospital beds

4" and 6" sizes available, consult factory.

## FEATURES

- Dual total lock brake design provides you an on and off option.
- Total locking brake locks both the swivel and wheel
- Double ball swivel raceways provides smooth operation and increased capacity
- Plastic shroud can be molded in a variety of colors to match your equipment



Streamline casters feature dual total lock brake design along with color options for plastic shroud. Wheels feature precision bearings.

## SWIVEL TOP PLATE MODELS

Wheel Diameter (Inches)	Tread Width (Inches)	Wheel Description	Capacity (Lbs)	Load Height Inches (mm)	Swivel Radius Inches (mm)	Wheel Bearing	Model Number
5	1-1/4	Rubber on Plastic	325	6-1/2" (165.5)	4-5/16" (110)	Precision Ball	SL-05RPP-125-SW-TP01

## TOTAL LOCK MODELS

Wheel Diameter (Inches)	Tread Width (Inches)	Wheel Description	Capacity (Lbs)	Load Height Inches (mm)	Swivel Radius Inches (mm)	Wheel Bearing	Model Number
5	1-1/4	Rubber on Plastic	325	6-1/2" (165.5)	4-5/16" (110)	Precision Ball	SL-05RPP-125-TL-TP01



Custom colors available. Consult factory.

## FITTINGS TP01

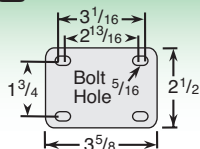



# OPTIMUS (OP)

## GRIP RING/THREADED STEM

FREE SWIVEL • FACE BRAKE

**NEW**



### APPLICATIONS

- Laboratory Equipment
- IV Stands
- Mobile Computer Stands
- Medical Equipment

Color options available, consult factory.

### FEATURES

- Intergrated thread guard on caster body plus additional wheel thread guards
- Nylon body construction
- Riveted axle
- Non marking resilient rounded tread Performa rubber wheels
- Pop in stems

Optimus Casters are designed to roll quiet and easy over different floor conditions within a hospital.

### SWIVEL MODELS

Wheel Diameter (Inches)	Tread Width (Inches)	Wheel Description	Capacity (Lbs)	Load Height Inches (mm)	Swivel Radius Inches (mm)	Wheel Bearing	Model Number
3-1/8	1	Performa Rubber	140	4-9/32 (109)	3-5/16" (84)	Plain Spanner	OP-03PRN-100-SW-___



### FACE BRAKE MODELS

Wheel Diameter (Inches)	Tread Width (Inches)	Wheel Description	Capacity (Lbs)	Load Height Inches (mm)	Swivel Radius Inches (mm)	Wheel Bearing	Model Number
3-1/8	1	Performa Rubber	140	4-9/32 (109)	3-5/16" (84)	Plain Spanner	OP-03PRN-100-FB-___



### GRIP RING STEM



### THREADED STEM



# NEOTEQ (CN) COMFORT ROLL

TOP PLATE/GRIP RING/THREADED/  
HOLLOW KINGPIN

FREE SWIVEL • TOTAL LOCK



## APPLICATIONS

- Laboratory Equipment
- IV Stands
- Mobile Computer Stands
- Medical Equipment

Grey Rubber wheels available, consult factory.

## FEATURES

- Bright Chrome Finish
- Matching Chrome Thread Guards for wheels
- Non-Marking Soft-Neoprene Rubber wheels
- Dual Ball Swivel Raceways for added strength
- **Total Lock Brake** models lock both swivel and wheel
- Precision ball bearings in wheels for easier rollability
- **NEW!** Durable coated metal dust shield

NEOTEQ FAMILY IS GROWING



Our Chrome NeoTeq series are designed to provide your equipment with a smooth and quiet roll.

## SWIVEL TOP PLATE MODELS

Wheel Diameter (Inches)	Tread Width (Inches)	Wheel Description	Capacity (Lbs)	Load Height Inches (mm)	Swivel Radius Inches (mm)	Wheel Bearing	Model Number
2	1	Neoprene Rubber	125	2-15/16" (75)	2" (51)	Precision Ball	CN-02NRP-100-SW-
2-1/2	1	Neoprene Rubber	165	3-1/2" (89)	2-1/2" (54)	Precision Ball	CN-25NRP-100-SW-
3	1	Neoprene Rubber	175	4-5/32" (105)	2-13/16" (71)	Precision Ball	CN-03NRP-100-SW-



## SWIVEL PLATE TOTAL LOCK MODELS

(LOCKS WHEEL AND SWIVEL)

Wheel Diameter (Inches)	Tread Width (Inches)	Wheel Description	Capacity (Lbs)	Load Height Inches (mm)	Swivel Radius Inches (mm)	Wheel Bearing	Model Number
2	1	Neoprene Rubber	125	2-15/16" (75)	2" (51)	Precision Ball	CN-02NRP-100-TL-
2-1/2	1	Neoprene Rubber	165	3-1/2" (89)	2-11/16" (56)	Precision Ball	CN-25NRP-100-TL-
3	1	Neoprene Rubber	175	4-5/32" (105)	2-13/16" (71)	Precision Ball	CN-03NRP-100-TL-



Grey rubber wheels available, consult factory.



Available in powder coated colors. Consult factory for minimum order quantities.



## FITTINGS

2-1/2" and 3" only for TP01.

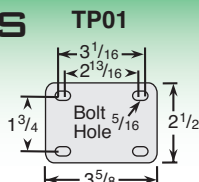

## TP02

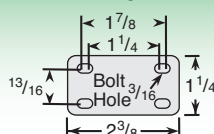

## TP02 Swivel Top Plate Fitting Patterns

2" diameter caster: 13/16" x 1-1/4" through 1-7/8" slotted  
3" diameter caster: 13/16" x 1-7/8" (not slotted)

# NEOTEQ (CN) COMFORT ROLL

## GRIP RING STEM MODELS

Wheel Diameter (Inches)	Tread Width (Inches)	Wheel Description	Capacity (Lbs)	Load Height Inches (mm)	Swivel Radius Inches (mm)	Wheel Bearing	Model Number
2	1	Neoprene Rubber	125	2-11/16" (68)	2" (51)	Precision Ball	CN-02NRP-100-SW-GR01
2-1/2	1	Neoprene Rubber	165	3-3/8" (86)	2-1/2" (54)	Precision Ball	CN-25NRP-100-SW-GR01
3	1	Neoprene Rubber	175	4" (102)	2-13/16" (71)	Precision Ball	CN-03NRP-100-SW-GR01



## GRIP RING STEM TOTAL LOCK MODELS

(LOCKS WHEEL AND SWIVEL)

2	1	Neoprene Rubber	125	2-11/16" (68)	2" (51)	Precision Ball	CN-02NRP-100-TL-GR01
2-1/2	1	Neoprene Rubber	165	3-3/8" (86)	2-11/16" (56)	Precision Ball	CN-25NRP-100-TL-GR01
3	1	Neoprene Rubber	175	4" (102)	2-13/16" (71)	Precision Ball	CN-03NRP-100-TL-GR01



## THREADED STEM MODELS

Wheel Diameter (Inches)	Tread Width (Inches)	Wheel Description	Capacity (Lbs)	Load Height Inches (mm)	Swivel Radius Inches (mm)	Wheel Bearing	Model Number
2	1	Neoprene Rubber	125	2-11/16" (68)	2" (51)	Precision Ball	CN-02NRP-100-SW-TS06
2-1/2	1	Neoprene Rubber	165	3-3/8" (86)	2-1/2" (54)	Precision Ball	CN-25NRP-100-SW-TS06
3	1	Neoprene Rubber	175	4" (102)	2-13/16" (71)	Precision Ball	CN-03NRP-100-SW-TS06



## THREADED STEM TOTAL LOCK MODELS

(LOCKS WHEEL AND SWIVEL)

2-1/2	1	Neoprene Rubber	165	3-3/8" (86)	2-11/16" (56)	Precision Ball	CN-25NRP-100-TL-TS06
3	1	Neoprene Rubber	175	4" (102)	2-13/16" (71)	Precision Ball	CN-03NRP-100-TL-TS06



## HOLLOW KINGPIN MODELS

Wheel Diameter (Inches)	Tread Width (Inches)	Wheel Description	Capacity (Lbs)	Load Height Inches (mm)	Swivel Radius Inches (mm)	Wheel Bearing	Model Number
2	1	Neoprene Rubber	125	2-11/16" (68)	2" (51)	Precision Ball	CN-02NRP-100-SW-HK04
2-1/2	1	Neoprene Rubber	165	3-3/8" (86)	2-1/2" (54)	Precision Ball	CN-25NRP-100-SW-HK04
3	1	Neoprene Rubber	175	4" (102)	2-13/16" (71)	Precision Ball	CN-03NRP-100-SW-HK04



Recommended for use with 3/8" diameter fittings.

## HOLLOW KINGPIN TOTAL LOCK MODELS

(LOCKS WHEEL AND SWIVEL)

2	1	Neoprene Rubber	125	2-11/16" (68)	2" (51)	Precision Ball	CN-02NRP-100-TL-HK04
2-1/2	1	Neoprene Rubber	165	3-3/8" (86)	2-11/16" (56)	Precision Ball	CN-25NRP-100-TL-HK04
3	1	Neoprene Rubber	175	4" (102)	2-13/16" (71)	Precision Ball	CN-03NRP-100-TL-HK04



Recommended for use with 3/8" diameter fittings.

Grey rubber wheels available, consult factory.

**GRIP RING STEM**

GR01      GR02      GR03

**THREADED STEM**

TS06

**HOLLOW RIVET**

Recommended for use with 3/8" diameter fittings.

See fitting chart for additional options.

# RAZER (RZ)

## TOP PLATE MODELS

FREE SWIVEL • TOTAL LOCK



Grey Rubber Wheel (GRP)



Grey TPR Wheel Model (TPP)

- APPLICATIONS**
- Laundry Hampers
  - Mobile Hospital Furniture
  - Bassinets
  - Hospital
  - Chairs/ Recliners
  - Home Healthcare Beds

- FEATURES**
- Economical
  - Polished chrome finish
  - Double ball swivel raceways for added strength
  - **Total Lock Brake** models lock both swivel and wheel
  - Full thread guards for added protection (except 2" diameter models)

Available in powder coated colors. Consult factory for minimum order quantities.



## SWIVEL TOP PLATE MODELS

Wheel Diameter (Inches)	Tread Width (Inches)	Wheel Description	Capacity (Lbs)	Load Height Inches (mm)	Swivel Radius Inches (mm)	Wheel Bearing	Model Number
2	3/4"	Grey Rubber	110	2-13/16" (71)	1.95" (50)	Plain	RZ-02GRN-070-SW-TP06
2	3/4"	Grey Rubber	110	2-13/16" (71)	1.95" (50)	Ball Bearing	RZ-02GRP-070-SW-TP06
2	3/4"	Grey TPR	110	2-13/16" (71)	1.95" (50)	Plain	RZ-02TPN-070-SW-TP06
3	7/8"	Grey Rubber	140	4.07" (103)	2.85" (73)	Ball Bearing	RZ-03GRP-090-SW-TP05
3	7/8"	Grey TPR	140	4.07" (103)	2.85" (73)	Ball Bearing	RZ-03TPP-090-SW-TP05
4	7/8"	Grey Rubber	160	4.92" (125)	3.35" (85)	Ball Bearing	RZ-04GRP-090-SW-TP05
4	7/8"	Grey TPR	160	4.92" (125)	3.35" (85)	Ball Bearing	RZ-04TPP-090-SW-TP05
5	7/8"	Grey Rubber	165	6.04" (153)	3.84" (98)	Ball Bearing	RZ-05GRP-090-SW-TP05
5	7/8"	Grey TPR	165	6.04" (153)	3.84" (98)	Ball Bearing	RZ-05TPP-090-SW-TP05

## SWIVEL TOP PLATE TOTAL LOCK MODELS

(LOCKS WHEEL AND SWIVEL)

Wheel Diameter (Inches)	Tread Width (Inches)	Wheel Description	Capacity (Lbs)	Load Height Inches (mm)	Swivel Radius Inches (mm)	Wheel Bearing	Model Number
2	3/4"	Grey Rubber	110	2-13/16" (71)	3.23" (82)	Plain	RZ-02GRN-070-TL-TP06
2	3/4"	Grey Rubber	110	2-13/16" (71)	3.23" (82)	Ball Bearing	RZ-02GRP-070-TL-TP06
2	3/4"	Grey TPR	110	2-13/16" (71)	3.23" (82)	Plain	RZ-02TPN-070-TL-TP06
3	7/8"	Grey Rubber	140	4.07" (103)	3.90" (104)	Ball Bearing	RZ-03GRP-090-TL-TP05
3	7/8"	Grey TPR	140	4.07" (103)	3.90" (104)	Ball Bearing	RZ-03TPP-090-TL-TP05
4	7/8"	Grey Rubber	160	4.92" (125)	4.19" (107)	Ball Bearing	RZ-04GRP-090-TL-TP05
4	7/8"	Grey TPR	160	4.92" (125)	4.19" (107)	Ball Bearing	RZ-04TPP-090-TL-TP05
5	7/8"	Grey Rubber	165	6.04" (153)	4.19" (107)	Ball Bearing	RZ-05GRP-090-TL-TP05
5	7/8"	Grey TPR	165	6.04" (153)	4.19" (107)	Ball Bearing	RZ-05TPP-090-TL-TP05



## TOP PLATE FITTING

Swivel Top Plate Pattern

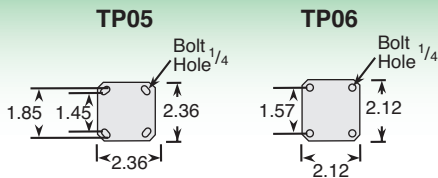

# RAZER (RZ)

## HOLLOW KINGPIN MODELS FREE SWIVEL • TOTAL LOCK



Grey Rubber Wheel (GRP)

Grey TPR Wheel Model (TPP)

### APPLICATIONS

- Laundry Hampers
- Mobile Hospital Furniture
- Bassinets
- Hospital
- Chairs/ Recliners
- Home Healthcare Beds

### FEATURES

- Economical
- Polished chrome finish
- Double ball swivel raceways for added strength
- **Total Lock Brake** models lock both swivel and wheel
- Full thread guards for added protection (except 2" diameter models)

## HOLLOW KINGPIN MODELS

Wheel Diameter (Inches)	Tread Width (Inches)	Wheel Description	Capacity (Lbs)	Load Height inches (mm)	Swivel Radius Inches (mm)	Wheel Bearing	Model Number
2	3/4"	Grey Rubber	110	2.75" (70)	1.95" (50)	Plain	RZ-02GRN-070-SW-HK04
2	3/4"	Grey Rubber	110	2.75" (70)	1.95" (50)	Ball Bearing	RZ-02GRP-070-SW-HK04
2	3/4"	Grey TPR	110	2.75" (70)	1.95" (50)	Plain	RZ-02TPN-070-SW-HK04
3	7/8"	Grey Rubber	140	3.98" (101)	2.85" (73)	Ball Bearing	RZ-03GRP-090-SW-HK04
3	7/8"	Grey TPR	140	3.98" (101)	2.85" (73)	Ball Bearing	RZ-03TPP-090-SW-HK04
4	7/8"	Grey Rubber	160	4.84" (123)	3.35" (85)	Ball Bearing	RZ-04GRP-090-SW-HK04
4	7/8"	Grey TPR	160	4.84" (123)	3.35" (85)	Ball Bearing	RZ-04TPP-090-SW-HK04
5	7/8"	Grey Rubber	165	5.95" (151)	3.84" (98)	Ball Bearing	RZ-05GRP-090-SW-HK04
5	7/8"	Grey TPR	165	5.95" (151)	3.84" (98)	Ball Bearing	RZ-05TPP-090-SW-HK04



## HOLLOW KINGPIN TOTAL LOCK MODELS (LOCKS WHEEL AND SWIVEL)

Wheel Diameter (Inches)	Tread Width (Inches)	Wheel Description	Capacity (Lbs)	Load Height inches (mm)	Swivel Radius Inches (mm)	Wheel Bearing	Model Number
2	3/4"	Grey Rubber	110	2.75" (70)	3.23" (82)	Plain	RZ-02GRN-070-TL-HK04
2	3/4"	Grey Rubber	110	2.75" (70)	3.23" (82)	Ball Bearing	RZ-02GRP-070-TL-HK04
2	3/4"	Grey TPR	110	2.75" (70)	3.23" (82)	Plain	RZ-02TPN-070-TL-HK04
3	7/8"	Grey Rubber	140	3.98" (101)	3.90" (104)	Ball Bearing	RZ-03GRP-090-TL-HK04
3	7/8"	Grey TPR	140	3.98" (101)	3.90" (104)	Ball Bearing	RZ-03TPP-090-TL-HK04
4	7/8"	Grey Rubber	160	4.84" (123)	4.19" (107)	Ball Bearing	RZ-04GRP-090-TL-HK04
4	7/8"	Grey TPR	160	4.84" (123)	4.19" (107)	Ball Bearing	RZ-04TPP-090-TL-HK04
5	7/8"	Grey Rubber	165	5.95" (151)	4.19" (107)	Ball Bearing	RZ-05GRP-090-TL-HK04
5	7/8"	Grey TPR	165	5.95" (151)	4.19" (107)	Ball Bearing	RZ-05TPP-090-TL-HK04



## HOLLOW RIVET

Recommended for use with 3/8" and M10 diameter fittings. Caster comes assembled.

# RAZER (RZ)

## GRIP RING STEM MODELS

FREE SWIVEL • TOTAL LOCK

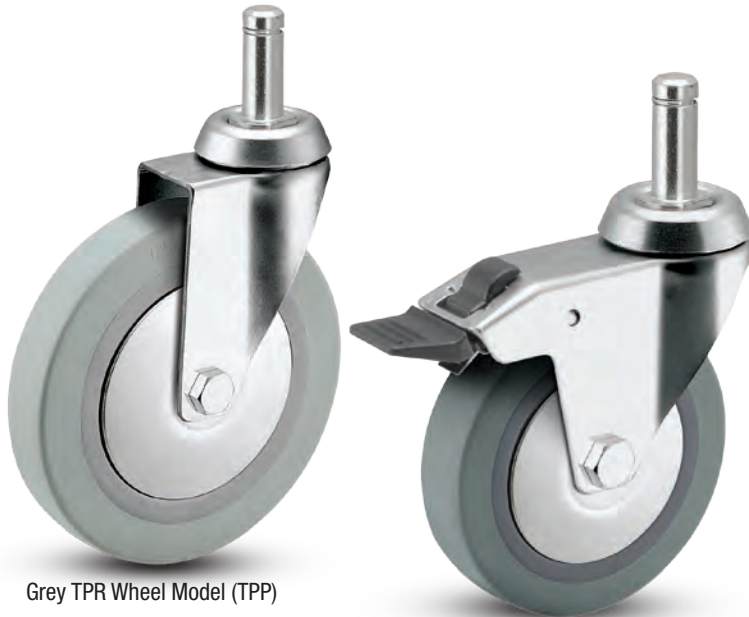

Grey TPR Wheel Model (TPP)

Grey Rubber Wheel (GRP)

### APPLICATIONS

- Laundry Hampers
- Mobile Hospital Furniture
- Bassinets
- Hospital
- Chairs/ Recliners
- Home Healthcare Beds

### FEATURES

- Economical
- Polished chrome finish
- Double ball swivel raceways for added strength
- **Total Lock Brake** models lock both swivel and wheel
- Full thread guards for added protection (except 2" diameter models)

Available in powder coated colors. Consult factory for minimum order quantities.



## GRIP RING STEM MODELS

Wheel Diameter (Inches)	Tread Width (Inches)	Wheel Description	Capacity (Lbs)	Load Height Inches (mm)	Swivel Radius Inches (mm)	Wheel Bearing	Model Number
2	3/4"	Grey Rubber	110	2.75" (70)	1.95" (50)	Plain	RZ-02GRN-070-SW-___
2	3/4"	Grey Rubber	110	2.75" (70)	1.95" (50)	Ball Bearing	RZ-02GRP-070-SW-___
2	3/4"	Grey TPR	110	2.75" (70)	1.95" (50)	Plain	RZ-02TPN-070-SW-___
3	7/8"	Grey Rubber	140	3.98" (101)	2.85" (73)	Ball Bearing	RZ-03GRP-090-SW-___
3	7/8"	Grey TPR	140	3.98" (101)	2.85" (73)	Ball Bearing	RZ-03TPP-090-SW-___
4	7/8"	Grey Rubber	160	4.84" (123)	3.35" (85)	Ball Bearing	RZ-04GRP-090-SW-___
4	7/8"	Grey TPR	160	4.84" (123)	3.35" (85)	Ball Bearing	RZ-04TPP-090-SW-___
5	7/8"	Grey Rubber	165	5.95" (151)	3.84" (98)	Ball Bearing	RZ-05GRP-090-SW-___
5	7/8"	Grey TPR	165	5.95" (151)	3.84" (98)	Ball Bearing	RZ-05TPP-090-SW-___



## GRIP RING STEM TOTAL LOCK MODELS

(LOCKS WHEEL AND SWIVEL)

Wheel Diameter (Inches)	Tread Width (Inches)	Wheel Description	Capacity (Lbs)	Load Height Inches (mm)	Swivel Radius Inches (mm)	Wheel Bearing	Model Number
2	3/4"	Grey Rubber	110	2.75" (70)	3.23" (82)	Plain	RZ-02GRN-070-TL-___
2	3/4"	Grey Rubber	110	2.75" (70)	3.23" (82)	Ball Bearing	RZ-02GRP-070-TL-___
2	3/4"	Grey TPR	110	2.75" (70)	3.23" (82)	Plain	RZ-02TPN-070-TL-___
3	7/8"	Grey Rubber	140	3.98" (101)	3.90" (104)	Ball Bearing	RZ-03GRP-090-TL-___
3	7/8"	Grey TPR	140	3.98" (101)	3.90" (104)	Ball Bearing	RZ-03TPP-090-TL-___
4	7/8"	Grey Rubber	160	4.84" (123)	4.19" (107)	Ball Bearing	RZ-04GRP-090-TL-___
4	7/8"	Grey TPR	160	4.84" (123)	4.19" (107)	Ball Bearing	RZ-04TPP-090-TL-___
5	7/8"	Grey Rubber	165	5.95" (151)	4.19" (107)	Ball Bearing	RZ-05GRP-090-TL-___
5	7/8"	Grey TPR	165	5.95" (151)	4.19" (107)	Ball Bearing	RZ-05TPP-090-TL-___



## GRIP RING STEM FITTINGS

See fittings page for more options.



Specify Grip Ring Stem (GR) code, see fittings at left for dimensions.

# RAZER (RZ)

## THREADED STEM MODELS

FREE SWIVEL • TOTAL LOCK



Grey TPR Wheel Model (TPP)



Grey Rubber Wheel (GRP)

### APPLICATIONS

- Laundry Hampers
- Mobile Hospital Furniture
- Bassinets
- Hospital
- Chairs/ Recliners
- Home Healthcare Beds

### FEATURES

- Economical
- Polished chrome finish
- Double ball swivel raceways for added strength
- **Total Lock Brake** models lock both swivel and wheel
- Full thread guards for added protection (except 2" diameter models)

## THREADED STEM MODELS

Wheel Diameter (Inches)	Tread Width (Inches)	Wheel Description	Capacity (Lbs)	Load Height Inches (mm)	Swivel Radius Inches (mm)	Wheel Bearing	Model Number
2	3/4"	Grey Rubber	110	2.75" (70)	1.95" (50)	Plain	RZ-02GRN-070-SW-_____
2	3/4"	Grey Rubber	110	2.75" (70)	1.95" (50)	Ball Bearing	RZ-02GRP-070-SW-_____
2	3/4"	Grey TPR	110	2.75" (70)	1.95" (50)	Plain	RZ-02TPN-070-SW-_____
3	7/8"	Grey Rubber	140	3.98" (101)	2.85" (73)	Ball Bearing	RZ-03GRP-090-SW-_____
3	7/8"	Grey TPR	140	3.98" (101)	2.85" (73)	Ball Bearing	RZ-03TPP-090-SW-_____
4	7/8"	Grey Rubber	160	4.84" (123)	3.35" (85)	Ball Bearing	RZ-04GRP-090-SW-_____
4	7/8"	Grey TPR	160	4.84" (123)	3.35" (85)	Ball Bearing	RZ-04TPP-090-SW-_____
5	7/8"	Grey Rubber	165	5.95" (151)	3.84" (98)	Ball Bearing	RZ-05GRP-090-SW-_____
5	7/8"	Grey TPR	165	5.95" (151)	3.84" (98)	Ball Bearing	RZ-05TPP-090-SW-_____



## THREADED STEM TOTAL LOCK MODELS

(LOCKS WHEEL AND SWIVEL)

Wheel Diameter (Inches)	Tread Width (Inches)	Wheel Description	Capacity (Lbs)	Load Height Inches (mm)	Swivel Radius Inches (mm)	Wheel Bearing	Model Number
2	3/4"	Grey Rubber	110	2.75" (70)	3.23" (82)	Plain	RZ-02GRN-070-TL-_____
2	3/4"	Grey Rubber	110	2.75" (70)	3.23" (82)	Ball Bearing	RZ-02GRP-070-TL-_____
2	3/4"	Grey TPR	110	2.75" (70)	3.23" (82)	Plain	RZ-02TPN-070-TL-_____
3	7/8"	Grey Rubber	140	3.98" (101)	3.90" (104)	Ball Bearing	RZ-03GRP-090-TL-_____
3	7/8"	Grey TPR	140	3.98" (101)	3.90" (104)	Ball Bearing	RZ-03TPP-090-TL-_____
4	7/8"	Grey Rubber	160	4.84" (123)	4.19" (107)	Ball Bearing	RZ-04GRP-090-TL-_____
4	7/8"	Grey TPR	160	4.84" (123)	4.19" (107)	Ball Bearing	RZ-04TPP-090-TL-_____
5	7/8"	Grey Rubber	165	5.95" (151)	4.19" (107)	Ball Bearing	RZ-05GRP-090-TL-_____
5	7/8"	Grey TPR	165	5.95" (151)	4.19" (107)	Ball Bearing	RZ-05TPP-090-TL-_____



## THREADED STEM FITTINGS

See fittings page for more options.

TS06

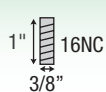

TS15

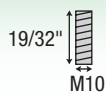

TS25



Specify Threaded Stem (TS) code, see fittings at left for dimensions:

# CHROME HOSPITAL (CH)

## TOP PLATE MODELS

FREE SWIVEL • TOTAL LOCK • DIRECTION LOCK



### APPLICATIONS

- Food Service
- Case Carts
- Utility Carts
- Hospital Equipment
- Institutional Equipment
- Store Fixtures
- Medical equipment

New chrome thread guards now available!

### FEATURES

- Chrome Plated Finish
- Dual Ball Swivel Raceways for added strength
- **Total Lock Brake** models lock both swivel and wheel
- Directional lock models lock swivel only (helps with steering)
- Precision ball bearings in wheels for easier rollability
- Wheels have full thread guards for added protection

The CH series brings you Chrome Hospital casters at an affordable price.

## SWIVEL TOP PLATE MODELS

Wheel Diameter (Inches)	Tread Width (Inches)	Wheel Description	Capacity (Lbs)	Load Height Inches (mm)	Swivel Radius Inches (mm)	Wheel Bearing	Model Number
3	1-1/4	Conductive Rubber	190	4-7/16" (113)	2-29/32" (74)	Annular Ball	CH-03CRB-125-SW-___
3	1-1/4	Thermoplastic Rubber	190	4-7/16" (113)	2-29/32" (74)	Precision Ball	CH-03TPP-125-SW-___
3	1-1/4	Anti-Microbial TPR	190	4-7/16" (113)	2-29/32" (74)	Precision Ball	CH-03AMP-125-SW-___
3	1-1/4	Polyurethane TPU	190	4-7/16" (113)	2-29/32" (74)	Precision Ball	CH-03PYP-125-SW-___
4	1-1/4	Conductive Rubber	240	5-7/16" (138)	3-37/64" (91)	Annular Ball	CH-04CRB-125-SW-___
4	1-1/4	Thermoplastic Rubber	240	5-7/16" (138)	3-37/64" (91)	Precision Ball	CH-04TPP-125-SW-___
4	1-1/4	Anti-Microbial TPR	240	5-7/16" (138)	3-37/64" (91)	Precision Ball	CH-04AMP-125-SW-___
4	1-1/4	Polyurethane TPU	240	5-7/16" (138)	3-37/64" (91)	Precision Ball	CH-04PYP-125-SW-___
5	1-1/4	Conductive Rubber	260	6-7/16" (163)	4-7/32" (108)	Annular Ball	CH-05CRB-125-SW-___
5	1-1/4	Thermoplastic Rubber	260	6-7/16" (163)	4-7/32" (108)	Precision Ball	CH-05TPP-125-SW-___
5	1-1/4	Anti-Microbial TPR	260	6-7/16" (163)	4-7/32" (108)	Precision Ball	CH-05AMP-125-SW-___
5	1-1/4	Polyurethane TPU	260	6-7/16" (163)	4-7/32" (108)	Precision Ball	CH-05PYP-125-SW-___
6	1-1/4	Conductive Rubber	260	7-13/32" (188)	4-39/64 (117)	Annular Ball	CH-06CRB-125-SW-___
6	1-1/4	Thermoplastic Rubber	260	7-13/32" (188)	4-39/64 (117)	Precision Ball	CH-06TPP-125-SW-___
6	1-1/4	Anti-Microbial TPR	260	7-13/32" (188)	4-39/64 (117)	Precision Ball	CH-06AMP-125-SW-___
6	1-1/4	Polyurethane TPU	260	7-13/32" (188)	4-39/64 (117)	Precision Ball	CH-06PYP-125-SW-___



Anti-Microbial wheels have light green tread.



To order chrome thread guard add "CTG" to end of model (Example: CH05TPP-125-SW-TP01-CTG).



Rigid Models available change "SW" to "RG"

## TOP PLATE FITTING

Swivel Top Plate Pattern

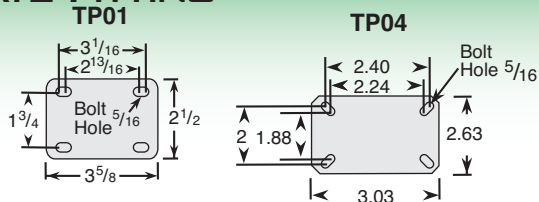

Specify Top Plate (TP) code, see fittings at left for dimensions.



# CHROME HOSPITAL (CH)

## SWIVEL TOP PLATE TOTAL LOCK MODELS (LOCKS WHEEL AND SWIVEL)

Wheel Diameter (Inches)	Tread Width (Inches)	Wheel Description	Capacity (Lbs)	Load Height Inches (mm)	Swivel Radius Inches (mm)	Wheel Bearing	Model Number
3	1-1/4	Conductive Rubber	190	4-7/16" (113)	4-1/4" (108)	Annular Ball	CH-03CRB-125-TL-__
3	1-1/4	Thermoplastic Rubber	190	4-7/16" (113)	4-1/4" (108)	Precision Ball	CH-03TPP-125-TL-__
3	1-1/4	Anti-Microbial TPR	190	4-7/16" (113)	4-1/4" (108)	Precision Ball	CH-03AMP-125-TL-__
3	1-1/4	Polyurethane TPU	190	4-7/16" (113)	4-1/4" (108)	Precision Ball	CH-03PYP-125-TL-__
4	1-1/4	Conductive Rubber	240	5-7/16" (138)	4-35/64" (115)	Annular Ball	CH-04CRB-125-TL-__
4	1-1/4	Thermoplastic Rubber	240	5-7/16" (138)	4-35/64" (115)	Precision Ball	CH-04TPP-125-TL-__
4	1-1/4	Anti-Microbial TPR	240	5-7/16" (138)	4-35/64" (115)	Precision Ball	CH-04AMP-125-TL-__
4	1-1/4	Polyurethane TPU	240	5-7/16" (138)	4-35/64" (115)	Precision Ball	CH-04PYP-125-TL-__
5	1-1/4	Conductive Rubber	260	6-7/16" (163)	4-55/64" (123)	Annular Ball	CH-05CRB-125-TL-__
5	1-1/4	Thermoplastic Rubber	260	6-7/16" (163)	4-55/64" (123)	Precision Ball	CH-05TPP-125-TL-__
5	1-1/4	Anti-Microbial TPR	260	6-7/16" (163)	4-55/64" (123)	Precision Ball	CH-05AMP-125-TL-__
5	1-1/4	Polyurethane TPU	260	6-7/16" (163)	4-55/64" (123)	Precision Ball	CH-05PYP-125-TL-__
6	1-1/4	Conductive Rubber	260	7-13/32" (188)	4-55/64" (123)	Annular Ball	CH-06CRB-125-TL-__
6	1-1/4	Thermoplastic Rubber	260	7-13/32" (188)	4-55/64" (123)	Precision Ball	CH-06TPP-125-TL-__
6	1-1/4	Anti-Microbial TPR	260	7-13/32" (188)	4-55/64" (123)	Precision Ball	CH-06AMP-125-TL-__
6	1-1/4	Polyurethane TPU	260	7-13/32" (188)	4-55/64" (123)	Precision Ball	CH-06PYP-125-TL-__



**Total Lock**  
Change "SW" to "TL". **Red** sticker on pedal.

## SWIVEL TOP PLATE DIRECTION LOCK MODELS (LOCKS SWIVEL ONLY)

Wheel Diameter (Inches)	Tread Width (Inches)	Wheel Description	Capacity (Lbs)	Load Height Inches (mm)	Swivel Radius Inches (mm)	Wheel Bearing	Model Number
3	1-1/4	Conductive Rubber	190	4-7/16" (113)	4-1/4" (108)	Annular Ball	CH-03CRB-125-DL-__
3	1-1/4	Thermoplastic Rubber	190	4-7/16" (113)	4-1/4" (108)	Precision Ball	CH-03TPP-125-DL-__
3	1-1/4	Anti-Microbial TPR	190	4-7/16" (113)	4-1/4" (108)	Precision Ball	CH-03AMP-125-DL-__
3	1-1/4	Polyurethane TPU	190	4-7/16" (113)	4-1/4" (108)	Precision Ball	CH-03PYP-125-DL-__
4	1-1/4	Conductive Rubber	240	5-7/16" (138)	4-35/64" (115)	Annular Ball	CH-04CRB-125-DL-__
4	1-1/4	Thermoplastic Rubber	240	5-7/16" (138)	4-35/64" (115)	Precision Ball	CH-04TPP-125-DL-__
4	1-1/4	Anti-Microbial TPR	240	5-7/16" (138)	4-35/64" (115)	Precision Ball	CH-04AMP-125-DL-__
4	1-1/4	Polyurethane TPU	240	5-7/16" (138)	4-35/64" (115)	Precision Ball	CH-04PYP-125-DL-__
5	1-1/4	Conductive Rubber	260	6-7/16" (163)	4-55/64" (123)	Annular Ball	CH-05CRB-125-DL-__
5	1-1/4	Thermoplastic Rubber	260	6-7/16" (163)	4-55/64" (123)	Precision Ball	CH-05TPP-125-DL-__
5	1-1/4	Anti-Microbial TPR	260	6-7/16" (163)	4-55/64" (123)	Precision Ball	CH-05AMP-125-DL-__
5	1-1/4	Polyurethane TPU	260	6-7/16" (163)	4-55/64" (123)	Precision Ball	CH-05PYP-125-DL-__
6	1-1/4	Conductive Rubber	260	7-13/32" (188)	4-55/64" (123)	Annular Ball	CH-06CRB-125-DL-__
6	1-1/4	Thermoplastic Rubber	260	7-13/32" (188)	4-55/64" (123)	Precision Ball	CH-06TPP-125-DL-__
6	1-1/4	Anti-Microbial TPR	260	7-13/32" (188)	4-55/64" (123)	Precision Ball	CH-06AMP-125-DL-__
6	1-1/4	Polyurethane TPU	260	7-13/32" (188)	4-55/64" (123)	Precision Ball	CH-06PYP-125-DL-__



**Direction Lock**  
Change "SW" to "DL". **Green** sticker on pedal.

### TOP PLATE FITTING

Swivel Top Plate Pattern

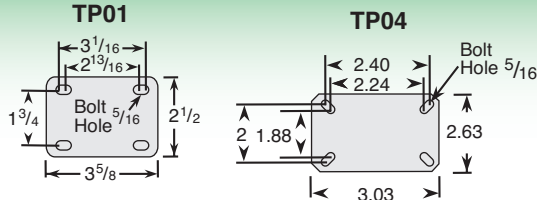

Specify Top Plate (TP) code, see fittings at left for dimensions.

# CHROME HOSPITAL (CH)

HOLLOW KINGPIN MODELS  
 FREE SWIVEL • TOTAL LOCK • DIRECTION LOCK



- APPLICATIONS**
- Food Service
  - Case Carts
  - Utility Carts
  - Hospital Equipment
  - Institutional Equipment
  - Store Fixtures
  - Medical equipment

New chrome thread guards now available!

- FEATURES**
- Chrome Plated Finish
  - Dual Ball Swivel Raceways for added strength
  - **Total Lock Brake** models lock both swivel and wheel
  - Directional lock models lock swivel only (helps with steering)
  - Precision ball bearings in wheels for easier rollability
  - Wheels have full thread guards for added protection

The CH series brings you Chrome Hospital casters at an affordable price.

## HOLLOW KINGPIN MODELS

Wheel Diameter (Inches)	Tread Width (Inches)	Wheel Description	Capacity (lbs)	Load Height Inches (mm)	Swivel Radius Inches (mm)	Wheel Bearing	Model Number
3	1-1/4	Conductive Rubber	190	4-5/16" (109)	2-29/32" (74)	Annular Ball	CH-03CRB-125-SW-HKU1
3	1-1/4	Thermoplastic Rubber	190	4-5/16" (109)	2-29/32" (74)	Precision Ball	CH-03TPP-125-SW-HKU1
3	1-1/4	Anti-Microbial TPR	190	4-5/16" (109)	2-29/32" (74)	Precision Ball	CH-03AMP-125-SW-HKU1
3	1-1/4	Polyurethane TPU	190	4-5/16" (109)	2-29/32" (74)	Precision Ball	CH-03PYP-125-SW-HKU1
4	1-1/4	Conductive Rubber	240	5-5/16" (135)	3-37/64" (91)	Annular Ball	CH-04CRB-125-SW-HKU1
4	1-1/4	Thermoplastic Rubber	240	5-5/16" (135)	3-37/64" (91)	Precision Ball	CH-04TPP-125-SW-HKU1
4	1-1/4	Anti-Microbial TPR	240	5-5/16" (135)	3-37/64" (91)	Precision Ball	CH-04AMP-125-SW-HKU1
4	1-1/4	Polyurethane TPU	240	5-5/16" (135)	3-37/64" (91)	Precision Ball	CH-04PYP-125-SW-HKU1
5	1-1/4	Conductive Rubber	260	6-5/16" (160)	4-7/32" (108)	Annular Ball	CH-05CRB-125-SW-HKU1
5	1-1/4	Thermoplastic Rubber	260	6-5/16" (160)	4-7/32" (108)	Precision Ball	CH-05TPP-125-SW-HKU1
5	1-1/4	Anti-Microbial TPR	260	6-5/16" (160)	4-7/32" (108)	Precision Ball	CH-05AMP-125-SW-HKU1
5	1-1/4	Polyurethane TPU	260	6-5/16" (160)	4-7/32" (108)	Precision Ball	CH-05PYP-125-SW-HKU1
6	1-1/4	Conductive Rubber	260	7-9/32" (185)	4-39/64" (117)	Annular Ball	CH-06CRB-125-SW-HKU1
6	1-1/4	Thermoplastic Rubber	260	7-9/32" (185)	4-39/64" (117)	Precision Ball	CH-06TPP-125-SW-HKU1
6	1-1/4	Anti-Microbial TPR	260	7-9/32" (185)	4-39/64" (117)	Precision Ball	CH-06AMP-125-SW-HKU1
6	1-1/4	Polyurethane TPU	260	7-9/32" (185)	4-39/64" (117)	Precision Ball	CH-06PYP-125-SW-HKU1



Anti-Microbial wheels have light green tread.



To order chrome thread guard add "CTG" to end of model (Example: CH05TPP-125-SW-HK01-CTG).

## HOLLOW KINGPIN

Caster is **provided unassembled** to make it easy to add your choice of fitting. If you would like these assembled change **HKU1** to **HK01**. 1/2 I.D.



# CHROME HOSPITAL (CH)

## HOLLOW KINGPIN MODELS

FREE SWIVEL • TOTAL LOCK • DIRECTION LOCK

### HOLLOW KINGPIN TOTAL LOCK MODELS

(LOCKS WHEEL AND SWIVEL)

Wheel Diameter (Inches)	Tread Width (Inches)	Wheel Description	Capacity (Lbs)	Load Height Inches (mm)	Swivel Radius Inches (mm)	Wheel Bearing	Model Number
3	1-1/4	Conductive Rubber	190	4-5/16" (109)	4-1/4" (108)	Annular Ball	CH-03CRB-125-TL-HKU1
3	1-1/4	Thermoplastic Rubber	190	4-5/16" (109)	4-1/4" (108)	Precision Ball	CH-03TPP-125-TL-HKU1
3	1-1/4	Anti-Microbial TPR	190	4-5/16" (109)	4-1/4" (108)	Precision Ball	CH-03AMP-125-TL-HKU1
3	1-1/4	Polyurethane TPU	190	4-5/16" (109)	4-1/4" (108)	Precision Ball	CH-03PYP-125-TL-HKU1
4	1-1/4	Conductive Rubber	240	5-5/16" (135)	4-35/64" (115)	Annular Ball	CH-04CRB-125-TL-HKU1
4	1-1/4	Thermoplastic Rubber	240	5-5/16" (135)	4-35/64" (115)	Precision Ball	CH-04TPP-125-TL-HKU1
4	1-1/4	Anti-Microbial TPR	240	5-5/16" (135)	4-35/64" (115)	Precision Ball	CH-04AMP-125-TL-HKU1
4	1-1/4	Polyurethane TPU	240	5-5/16" (135)	4-35/64" (115)	Precision Ball	CH-04PYP-125-TL-HKU1
5	1-1/4	Conductive Rubber	260	6-5/16" (160)	4-55/64" (123)	Annular Ball	CH-05CRB-125-TL-HKU1
5	1-1/4	Thermoplastic Rubber	260	6-5/16" (160)	4-55/64" (123)	Precision Ball	CH-05TPP-125-TL-HKU1
5	1-1/4	Anti-Microbial TPR	260	6-5/16" (160)	4-55/64" (123)	Precision Ball	CH-05AMP-125-TL-HKU1
5	1-1/4	Polyurethane TPU	260	6-5/16" (160)	4-55/64" (123)	Precision Ball	CH-05PYP-125-TL-HKU1
6	1-1/4	Conductive Rubber	260	7-9/32" (185)	4-55/64" (123)	Annular Ball	CH-06CRB-125-TL-HKU1
6	1-1/4	Thermoplastic Rubber	260	7-9/32" (185)	4-55/64" (123)	Precision Ball	CH-06TPP-125-TL-HKU1
6	1-1/4	Anti-Microbial TPR	260	7-9/32" (185)	4-55/64" (123)	Precision Ball	CH-06AMP-125-TL-HKU1
6	1-1/4	Polyurethane TPU	260	7-9/32" (185)	4-55/64" (123)	Precision Ball	CH-06PYP-125-TL-HKU1



**Total Lock**  
Change "SW"  
to "TL". Red  
sticker on pedal.

### HOLLOW KINGPIN DIRECTION LOCK MODELS

(LOCKS SWIVEL ONLY)

Wheel Diameter (Inches)	Tread Width (Inches)	Wheel Description	Capacity (Lbs)	Load Height Inches (mm)	Swivel Radius Inches (mm)	Wheel Bearing	Model Number
3	1-1/4	Conductive Rubber	190	4-5/16" (109)	4-1/4" (108)	Annular Ball	CH-03CRB-125-DL-HKU1
3	1-1/4	Thermoplastic Rubber	190	4-5/16" (109)	4-1/4" (108)	Precision Ball	CH-03TPP-125-DL-HKU1
3	1-1/4	Anti-Microbial TPR	190	4-5/16" (109)	4-1/4" (108)	Precision Ball	CH-03AMP-125-DL-HKU1
3	1-1/4	Polyurethane TPU	190	4-5/16" (109)	4-1/4" (108)	Precision Ball	CH-03PYP-125-DL-HKU1
4	1-1/4	Conductive Rubber	240	5-5/16" (135)	4-35/64" (115)	Annular Ball	CH-04CRB-125-DL-HKU1
4	1-1/4	Thermoplastic Rubber	240	5-5/16" (135)	4-35/64" (115)	Precision Ball	CH-04TPP-125-DL-HKU1
4	1-1/4	Anti-Microbial TPR	240	5-5/16" (135)	4-35/64" (115)	Precision Ball	CH-04AMP-125-DL-HKU1
4	1-1/4	Polyurethane TPU	240	5-5/16" (135)	4-35/64" (115)	Precision Ball	CH-04PYP-125-DL-HKU1
5	1-1/4	Conductive Rubber	260	6-5/16" (160)	4-55/64" (123)	Annular Ball	CH-05CRB-125-DL-HKU1
5	1-1/4	Thermoplastic Rubber	260	6-5/16" (160)	4-55/64" (123)	Precision Ball	CH-05TPP-125-DL-HKU1
5	1-1/4	Anti-Microbial TPR	260	6-5/16" (160)	4-55/64" (123)	Precision Ball	CH-05AMP-125-DL-HKU1
5	1-1/4	Polyurethane TPU	260	6-5/16" (160)	4-55/64" (123)	Precision Ball	CH-05PYP-125-DL-HKU1
6	1-1/4	Conductive Rubber	260	7-9/32" (185)	4-55/64" (123)	Annular Ball	CH-06CRB-125-DL-HKU1
6	1-1/4	Thermoplastic Rubber	260	7-9/32" (185)	4-55/64" (123)	Precision Ball	CH-06TPP-125-DL-HKU1
6	1-1/4	Anti-Microbial TPR	260	7-9/32" (185)	4-55/64" (123)	Precision Ball	CH-06AMP-125-DL-HKU1
6	1-1/4	Polyurethane TPU	260	7-9/32" (185)	4-55/64" (123)	Precision Ball	CH-06PYP-125-DL-HKU1



**Direction Lock**  
Change "SW"  
to "DL". Green  
sticker on pedal.

### HOLLOW KINGPIN

Caster is **provided unassembled** to make it easy to add your choice of fitting. If you would like these assembled change **HKU1** to **HK01**. 1/2 I.D.



# CHROME HOSPITAL (CH)

## GRIP RING STEM MODELS

FREE SWIVEL • TOTAL LOCK • DIRECTION LOCK



### APPLICATIONS

- Food Service
- Case Carts
- Utility Carts
- Hospital Equipment
- Institutional Equipment
- Store Fixtures
- Medical equipment

New chrome thread guards now available!

### FEATURES

- Chrome Plated Finish
- Dual Ball Swivel Raceways for added strength
- **Total Lock Brake** models lock both swivel and wheel
- Directional lock models lock swivel only (helps with steering)
- Precision ball bearings in wheels for easier rollability
- Wheels have full thread guards for added protection

The CH series brings you Chrome Hospital casters at an affordable price.

## GRIP RING STEM MODELS

Wheel Diameter (Inches)	Tread Width (Inches)	Wheel Description	Capacity (lbs)	Load Height Inches (mm)	Swivel Radius Inches (mm)	Wheel Bearing	Model Number
3	1-1/4	Conductive Rubber	190	4-5/16" (109)	2-29/32" (74)	Annular Ball	CH-03CRB-125-SW-____
3	1-1/4	Thermoplastic Rubber	190	4-5/16" (109)	2-29/32" (74)	Precision Ball	CH-03TPP-125-SW-____
3	1-1/4	Anti-Microbial TPR	190	4-5/16" (109)	2-29/32" (74)	Precision Ball	CH-03AMP-125-SW-____
3	1-1/4	Polyurethane TPU	190	4-5/16" (109)	2-29/32" (74)	Precision Ball	CH-03PYP-125-SW-____
4	1-1/4	Conductive Rubber	240	5-5/16" (135)	3-37/64" (91)	Annular Ball	CH-04CRB-125-SW-____
4	1-1/4	Thermoplastic Rubber	240	5-5/16" (135)	3-37/64" (91)	Precision Ball	CH-04TPP-125-SW-____
4	1-1/4	Anti-Microbial TPR	240	5-5/16" (135)	3-37/64" (91)	Precision Ball	CH-04AMP-125-SW-____
4	1-1/4	Polyurethane TPU	240	5-5/16" (135)	3-37/64" (91)	Precision Ball	CH-04PYP-125-SW-____
5	1-1/4	Conductive Rubber	260	6-5/16" (160)	4-7/32" (108)	Annular Ball	CH-05CRB-125-SW-____
5	1-1/4	Thermoplastic Rubber	260	6-5/16" (160)	4-7/32" (108)	Precision Ball	CH-05TPP-125-SW-____
5	1-1/4	Anti-Microbial TPR	260	6-5/16" (160)	4-7/32" (108)	Precision Ball	CH-05AMP-125-SW-____
5	1-1/4	Polyurethane TPU	260	6-5/16" (160)	4-7/32" (108)	Precision Ball	CH-05PYP-125-SW-____
6	1-1/4	Conductive Rubber	260	7-9/32" (185)	4-39/64" (117)	Annular Ball	CH-06CRB-125-SW-____
6	1-1/4	Thermoplastic Rubber	260	7-9/32" (185)	4-39/64" (117)	Precision Ball	CH-06TPP-125-SW-____
6	1-1/4	Anti-Microbial TPR	260	7-9/32" (185)	4-39/64" (117)	Precision Ball	CH-06AMP-125-SW-____
6	1-1/4	Polyurethane TPU	260	7-9/32" (185)	4-39/64" (117)	Precision Ball	CH-06PYP-125-SW-____



Anti-Microbial wheels have light green tread.



To order chrome thread guard add "CTG" to end of model (Example: CH05TPP-125-SW-GR02-CTG).

## GRIP RING STEM FITTINGS

See fittings page for more options.

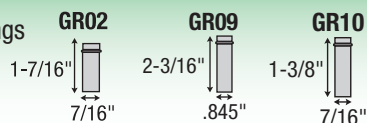

Specify Grip Ring Stem (GR) code, see fittings at left for dimensions.

# CHROME HOSPITAL (CH)

## GRIP RING STEM TOTAL LOCK MODELS (LOCKS WHEEL AND SWIVEL)

Wheel Diameter (Inches)	Tread Width (Inches)	Wheel Description	Capacity (Lbs)	Load Height Inches (mm)	Swivel Radius Inches (mm)	Wheel Bearing	Model Number
3	1-1/4	Conductive Rubber	190	4-5/16" (109)	4-1/4" (108)	Annular Ball	CH-03CRB-125-TL-____
3	1-1/4	Thermoplastic Rubber	190	4-5/16" (109)	4-1/4" (108)	Precision Ball	CH-03TPP-125-TL-____
3	1-1/4	Anti-Microbial TPR	190	4-5/16" (109)	4-1/4" (108)	Precision Ball	CH-03AMP-125-TL-____
3	1-1/4	Polyurethane TPU	190	4-5/16" (109)	4-1/4" (108)	Precision Ball	CH-03PYP-125-TL-____
4	1-1/4	Conductive Rubber	240	5-5/16" (135)	4-35/64" (115)	Annular Ball	CH-04CRB-125-TL-____
4	1-1/4	Thermoplastic Rubber	240	5-5/16" (135)	4-35/64" (115)	Precision Ball	CH-04TPP-125-TL-____
4	1-1/4	Anti-Microbial TPR	240	5-5/16" (135)	4-35/64" (115)	Precision Ball	CH-04AMP-125-TL-____
4	1-1/4	Polyurethane TPU	240	5-5/16" (135)	4-35/64" (115)	Precision Ball	CH-04PYP-125-TL-____
5	1-1/4	Conductive Rubber	260	6-5/16" (160)	4-55/64" (123)	Annular Ball	CH-05CRB-125-TL-____
5	1-1/4	Thermoplastic Rubber	260	6-5/16" (160)	4-55/64" (123)	Precision Ball	CH-05TPP-125-TL-____
5	1-1/4	Anti-Microbial TPR	260	6-5/16" (160)	4-55/64" (123)	Precision Ball	CH-05AMP-125-TL-____
5	1-1/4	Polyurethane TPU	260	6-5/16" (160)	4-55/64" (123)	Precision Ball	CH-05PYP-125-TL-____
6	1-1/4	Conductive Rubber	260	7-9/32" (185)	4-55/64" (123)	Annular Ball	CH-06CRB-125-TL-____
6	1-1/4	Thermoplastic Rubber	260	7-9/32" (185)	4-55/64" (123)	Precision Ball	CH-06TPP-125-TL-____
6	1-1/4	Anti-Microbial TPR	260	7-9/32" (185)	4-55/64" (123)	Precision Ball	CH-06AMP-125-TL-____
6	1-1/4	Polyurethane TPU	260	7-9/32" (185)	4-55/64" (123)	Precision Ball	CH-06PYP-125-TL-____



**Total Lock**  
Change "SW"  
to "TL". Red  
sticker on pedal.

## GRIP RING STEM DIRECTION LOCK MODELS (LOCKS SWIVEL ONLY)

Wheel Diameter (Inches)	Tread Width (Inches)	Wheel Description	Capacity (Lbs)	Load Height Inches (mm)	Swivel Radius Inches (mm)	Wheel Bearing	Model Number
3	1-1/4	Conductive Rubber	190	4-5/16" (109)	4-1/4" (108)	Annular Ball	CH-03CRB-125-DL-____
3	1-1/4	Thermoplastic Rubber	190	4-5/16" (109)	4-1/4" (108)	Precision Ball	CH-03TPP-125-DL-____
3	1-1/4	Anti-Microbial TPR	190	4-5/16" (109)	4-1/4" (108)	Precision Ball	CH-03AMP-125-DL-____
3	1-1/4	Polyurethane TPU	190	4-5/16" (109)	4-1/4" (108)	Precision Ball	CH-03PYP-125-DL-____
4	1-1/4	Conductive Rubber	240	5-5/16" (135)	4-35/64" (115)	Annular Ball	CH-04CRB-125-DL-____
4	1-1/4	Thermoplastic Rubber	240	5-5/16" (135)	4-35/64" (115)	Precision Ball	CH-04TPP-125-DL-____
4	1-1/4	Anti-Microbial TPR	240	5-5/16" (135)	4-35/64" (115)	Precision Ball	CH-04AMP-125-DL-____
4	1-1/4	Polyurethane TPU	240	5-5/16" (135)	4-35/64" (115)	Precision Ball	CH-04PYP-125-DL-____
5	1-1/4	Conductive Rubber	260	6-5/16" (160)	4-55/64" (123)	Annular Ball	CH-05CRB-125-DL-____
5	1-1/4	Thermoplastic Rubber	260	6-5/16" (160)	4-55/64" (123)	Precision Ball	CH-05TPP-125-DL-____
5	1-1/4	Anti-Microbial TPR	260	6-5/16" (160)	4-55/64" (123)	Precision Ball	CH-05AMP-125-DL-____
5	1-1/4	Polyurethane TPU	260	6-5/16" (160)	4-55/64" (123)	Precision Ball	CH-05PYP-125-DL-____
6	1-1/4	Conductive Rubber	260	7-9/32" (185)	4-55/64" (123)	Annular Ball	CH-06CRB-125-DL-____
6	1-1/4	Thermoplastic Rubber	260	7-9/32" (185)	4-55/64" (123)	Precision Ball	CH-06TPP-125-DL-____
6	1-1/4	Anti-Microbial TPR	260	7-9/32" (185)	4-55/64" (123)	Precision Ball	CH-06AMP-125-DL-____
6	1-1/4	Polyurethane TPU	260	7-9/32" (185)	4-55/64" (123)	Precision Ball	CH-06PYP-125-DL-____



**Direction Lock**  
Change "SW"  
to "DL". Green  
sticker on pedal.

Stems ship with a loose bolt for easier alignment of the directional lock. The direction lock caster will not remain in a fixed position when used with a grip ring stem.

Specify Grip Ring Stem (GR) code, see fittings at left for dimensions.

## GRIP RING STEM FITTINGS

See fittings page for more options.

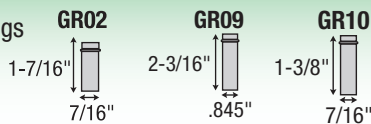

# CHROME HOSPITAL (CH)

EXPANDING ADAPTER STEM MODELS  
 FREE SWIVEL • TOTAL LOCK • DIRECTION LOCK



XRR3 Shown

XRN1 Shown

- APPLICATIONS**
- Food Service
  - Case Carts
  - Utility Carts
  - Hospital Equipment
  - Institutional Equipment
  - Store Fixtures
  - Medical equipment

New chrome thread guards now available!

- FEATURES**
- Chrome Plated Finish
  - Dual Ball Swivel Raceways for added strength
  - **Total Lock Brake** models lock both swivel and wheel
  - Directional lock models lock swivel only (helps with steering)
  - Precision ball bearings in wheels for easier rollability
  - Wheels have full thread guards for added protection

The CH series brings you Chrome Hospital casters at an affordable price.

## EXPANDING ADAPTER STEM MODELS

Wheel Diameter (Inches)	Tread Width (Inches)	Wheel Description	Capacity (Lbs)	Load Height Inches (mm)	Swivel Radius Inches (mm)	Wheel Bearing	Model Number
3	1-1/4	Conductive Rubber	190	4-5/16" (109)	2-29/32" (74)	Annular Ball	CH-03CRB-125-SW-____
3	1-1/4	Thermoplastic Rubber	190	4-5/16" (109)	2-29/32" (74)	Precision Ball	CH-03TPP-125-SW-____
3	1-1/4	Anti-Microbial TPR	190	4-5/16" (109)	2-29/32" (74)	Precision Ball	CH-03AMP-125-SW-____
3	1-1/4	Polyurethane TPU	190	4-5/16" (109)	2-29/32" (74)	Precision Ball	CH-03PYP-125-SW-____
4	1-1/4	Conductive Rubber	240	5-5/16" (135)	3-37/64" (91)	Annular Ball	CH-04CRB-125-SW-____
4	1-1/4	Thermoplastic Rubber	240	5-5/16" (135)	3-37/64" (91)	Precision Ball	CH-04TPP-125-SW-____
4	1-1/4	Anti-Microbial TPR	240	5-5/16" (135)	3-37/64" (91)	Precision Ball	CH-04AMP-125-SW-____
4	1-1/4	Polyurethane TPU	240	5-5/16" (135)	3-37/64" (91)	Precision Ball	CH-04PYP-125-SW-____
5	1-1/4	Conductive Rubber	260	6-5/16" (160)	4-7/32" (108)	Annular Ball	CH-05CRB-125-SW-____
5	1-1/4	Thermoplastic Rubber	260	6-5/16" (160)	4-7/32" (108)	Precision Ball	CH-05TPP-125-SW-____
5	1-1/4	Anti-Microbial TPR	260	6-5/16" (160)	4-7/32" (108)	Precision Ball	CH-05AMP-125-SW-____
5	1-1/4	Polyurethane TPU	260	6-5/16" (160)	4-7/32" (108)	Precision Ball	CH-05PYP-125-SW-____
6	1-1/4	Conductive Rubber	260	7-9/32" (185)	4-39/64" (117)	Annular Ball	CH-06CRB-125-SW-____
6	1-1/4	Thermoplastic Rubber	260	7-9/32" (185)	4-39/64" (117)	Precision Ball	CH-06TPP-125-SW-____
6	1-1/4	Anti-Microbial TPR	260	7-9/32" (185)	4-39/64" (117)	Precision Ball	CH-06AMP-125-SW-____
6	1-1/4	Polyurethane TPU	260	7-9/32" (185)	4-39/64" (117)	Precision Ball	CH-06PYP-125-SW-____



Anti-Microbial wheels have light green tread.



To order chrome thread guard add "CTG" to end of model  
 (Example: CH05TPP-125-SW-XRN1-CTG).

Specify Expanding Adapter Stem (XR) code, see fittings at left for dimensions.

## EXPANDING ADAPTER STEM FITTINGS

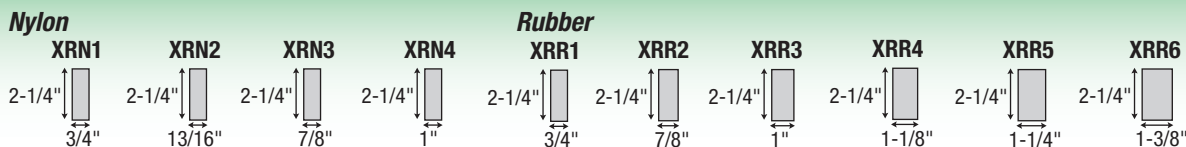

See fittings page for descriptions and more options.

# CHROME HOSPITAL (CH)

## EXPANDING ADAPTER STEM TOTAL LOCK MODELS (LOCKS WHEEL AND SWIVEL)

Wheel Diameter (Inches)	Tread Width (Inches)	Wheel Description	Capacity (Lbs)	Load Height Inches (mm)	Swivel Radius Inches (mm)	Wheel Bearing	Model Number
3	1-1/4	Conductive Rubber	190	4-5/16" (109)	4-1/4" (108)	Annular Ball	CH-03CRB-125-TL-_____
3	1-1/4	Thermoplastic Rubber	190	4-5/16" (109)	4-1/4" (108)	Precision Ball	CH-03TPP-125-TL-_____
3	1-1/4	Anti-Microbial TPR	190	4-5/16" (109)	4-1/4" (108)	Precision Ball	CH-03AMP-125-TL-_____
3	1-1/4	Polyurethane TPU	190	4-5/16" (109)	4-1/4" (108)	Precision Ball	CH-03PYP-125-TL-_____
4	1-1/4	Conductive Rubber	240	5-5/16" (135)	4-35/64" (115)	Annular Ball	CH-04CRB-125-TL-_____
4	1-1/4	Thermoplastic Rubber	240	5-5/16" (135)	4-35/64" (115)	Precision Ball	CH-04TPP-125-TL-_____
4	1-1/4	Anti-Microbial TPR	240	5-5/16" (135)	4-35/64" (115)	Precision Ball	CH-04AMP-125-TL-_____
4	1-1/4	Polyurethane TPU	240	5-5/16" (135)	4-35/64" (115)	Precision Ball	CH-04PYP-125-TL-_____
5	1-1/4	Conductive Rubber	260	6-5/16" (160)	4-55/64" (123)	Annular Ball	CH-05CRB-125-TL-_____
5	1-1/4	Thermoplastic Rubber	260	6-5/16" (160)	4-55/64" (123)	Precision Ball	CH-05TPP-125-TL-_____
5	1-1/4	Anti-Microbial TPR	260	6-5/16" (160)	4-55/64" (123)	Precision Ball	CH-05AMP-125-TL-_____
5	1-1/4	Polyurethane TPU	260	6-5/16" (160)	4-55/64" (123)	Precision Ball	CH-05PYP-125-TL-_____
6	1-1/4	Conductive Rubber	260	7-9/32" (185)	4-55/64" (123)	Annular Ball	CH-06CRB-125-TL-_____
6	1-1/4	Thermoplastic Rubber	260	7-9/32" (185)	4-55/64" (123)	Precision Ball	CH-06TPP-125-TL-_____
6	1-1/4	Anti-Microbial TPR	260	7-9/32" (185)	4-55/64" (123)	Precision Ball	CH-06AMP-125-TL-_____
6	1-1/4	Polyurethane TPU	260	7-9/32" (185)	4-55/64" (123)	Precision Ball	CH-06PYP-125-TL-_____



**Total Lock**  
Change "SW" to "TL". **Red** sticker on pedal.

## EXPANDING ADAPTER STEM DIRECTION LOCK MODELS (LOCKS SWIVEL ONLY)

Wheel Diameter (Inches)	Tread Width (Inches)	Wheel Description	Capacity (Lbs)	Load Height Inches (mm)	Swivel Radius Inches (mm)	Wheel Bearing	Model Number
3	1-1/4	Conductive Rubber	190	4-5/16" (109)	4-1/4" (108)	Annular Ball	CH-03CRB-125-DL-_____
3	1-1/4	Thermoplastic Rubber	190	4-5/16" (109)	4-1/4" (108)	Precision Ball	CH-03TPP-125-DL-_____
3	1-1/4	Anti-Microbial TPR	190	4-5/16" (109)	4-1/4" (108)	Precision Ball	CH-03AMP-125-DL-_____
3	1-1/4	Polyurethane TPU	190	4-5/16" (109)	4-1/4" (108)	Precision Ball	CH-03PYP-125-DL-_____
4	1-1/4	Conductive Rubber	240	5-5/16" (135)	4-35/64" (115)	Annular Ball	CH-04CRB-125-DL-_____
4	1-1/4	Thermoplastic Rubber	240	5-5/16" (135)	4-35/64" (115)	Precision Ball	CH-04TPP-125-DL-_____
4	1-1/4	Anti-Microbial TPR	240	5-5/16" (135)	4-35/64" (115)	Precision Ball	CH-04AMP-125-DL-_____
4	1-1/4	Polyurethane TPU	240	5-5/16" (135)	4-35/64" (115)	Precision Ball	CH-04PYP-125-DL-_____
5	1-1/4	Conductive Rubber	260	6-5/16" (160)	4-55/64" (123)	Annular Ball	CH-05CRB-125-DL-_____
5	1-1/4	Thermoplastic Rubber	260	6-5/16" (160)	4-55/64" (123)	Precision Ball	CH-05TPP-125-DL-_____
5	1-1/4	Anti-Microbial TPR	260	6-5/16" (160)	4-55/64" (123)	Precision Ball	CH-05AMP-125-DL-_____
5	1-1/4	Polyurethane TPU	260	6-5/16" (160)	4-55/64" (123)	Precision Ball	CH-05PYP-125-DL-_____
6	1-1/4	Conductive Rubber	260	7-9/32" (185)	4-55/64" (123)	Annular Ball	CH-06CRB-125-DL-_____
6	1-1/4	Thermoplastic Rubber	260	7-9/32" (185)	4-55/64" (123)	Precision Ball	CH-06TPP-125-DL-_____
6	1-1/4	Anti-Microbial TPR	260	7-9/32" (185)	4-55/64" (123)	Precision Ball	CH-06AMP-125-DL-_____
6	1-1/4	Polyurethane TPU	260	7-9/32" (185)	4-55/64" (123)	Precision Ball	CH-06PYP-125-DL-_____



**Direction Lock**  
Change "SW" to "DL". **Green** sticker on pedal.

Stems ship with a loose bolt for easier alignment of the directional lock.

Specify Expanding Adapter Stem (XR) code, see fittings at left for dimensions.

## EXPANDING ADAPTER STEM FITTINGS

<b>Nylon</b>				<b>Rubber</b>					
<b>XRN1</b>	<b>XRN2</b>	<b>XRN3</b>	<b>XRN4</b>	<b>XRR1</b>	<b>XRR2</b>	<b>XRR3</b>	<b>XRR4</b>	<b>XRR5</b>	<b>XRR6</b>
2-1/4" ↑ 3/4"	2-1/4" ↑ 13/16"	2-1/4" ↑ 7/8"	2-1/4" ↑ 1"	2-1/4" ↑ 3/4"	2-1/4" ↑ 7/8"	2-1/4" ↑ 1"	2-1/4" ↑ 1-1/8"	2-1/4" ↑ 1-1/4"	2-1/4" ↑ 1-3/8"

# CHROME HOSPITAL (CH)

THREADED STEM MODELS  
 FREE SWIVEL • TOTAL LOCK • DIRECTION LOCK



- APPLICATIONS**
- Food Service
  - Case Carts
  - Utility Carts
  - Hospital Equipment
  - Institutional Equipment
  - Store Fixtures
  - Medical equipment

New chrome thread guards now available!

- FEATURES**
- Chrome Plated Finish
  - Dual Ball Swivel Raceways for added strength
  - **Total Lock Brake** models lock both swivel and wheel
  - Directional lock models lock swivel only (helps with Steering)
  - Precision ball bearings in wheels for easier rollability
  - Wheels have full thread guards for added protection

The CH series brings you Chrome Hospital casters at an affordable price.

## THREADED STEM MODELS

Wheel Diameter (Inches)	Tread Width (Inches)	Wheel Description	Capacity (Lbs)	Load Height Inches (mm)	Swivel Radius Inches (mm)	Wheel Bearing	Model Number
3	1-1/4	Conductive Rubber	190	4-5/16" (109)	2-29/32" (74)	Annular Ball	CH-03CRB-125-SW-____
3	1-1/4	Thermoplastic Rubber	190	4-5/16" (109)	2-29/32" (74)	Precision Ball	CH-03TPP-125-SW-____
3	1-1/4	Anti-Microbial TPR	190	4-5/16" (109)	2-29/32" (74)	Precision Ball	CH-03AMP-125-SW-____
3	1-1/4	Polyurethane TPU	190	4-5/16" (109)	2-29/32" (74)	Precision Ball	CH-03PYP-125-SW-____
4	1-1/4	Conductive Rubber	240	5-5/16" (135)	3-37/64" (91)	Annular Ball	CH-04CRB-125-SW-____
4	1-1/4	Thermoplastic Rubber	240	5-5/16" (135)	3-37/64" (91)	Precision Ball	CH-04TPP-125-SW-____
4	1-1/4	Anti-Microbial TPR	240	5-5/16" (135)	3-37/64" (91)	Precision Ball	CH-04AMP-125-SW-____
4	1-1/4	Polyurethane TPU	240	5-5/16" (135)	3-37/64" (91)	Precision Ball	CH-04PYP-125-SW-____
5	1-1/4	Conductive Rubber	260	6-5/16" (160)	4-7/32" (108)	Annular Ball	CH-05CRB-125-SW-____
5	1-1/4	Thermoplastic Rubber	260	6-5/16" (160)	4-7/32" (108)	Precision Ball	CH-05TPP-125-SW-____
5	1-1/4	Anti-Microbial TPR	260	6-5/16" (160)	4-7/32" (108)	Precision Ball	CH-05AMP-125-SW-____
5	1-1/4	Polyurethane TPU	260	6-5/16" (160)	4-7/32" (108)	Precision Ball	CH-05PYP-125-SW-____
6	1-1/4	Conductive Rubber	260	7-9/32" (185)	4-39/64" (117)	Annular Ball	CH-06CRB-125-SW-____
6	1-1/4	Thermoplastic Rubber	260	7-9/32" (185)	4-39/64" (117)	Precision Ball	CH-06TPP-125-SW-____
6	1-1/4	Anti-Microbial TPR	260	7-9/32" (185)	4-39/64" (117)	Precision Ball	CH-06AMP-125-SW-____
6	1-1/4	Polyurethane TPU	260	7-9/32" (185)	4-39/64" (117)	Precision Ball	CH-06PYP-125-SW-____



Anti-Microbial wheels have light green tread.



To order chrome thread guard add "CTG" to end of model  
 (Example: CH05TPP-125-SW-TS02-CTG).

## THREADED STEM FITTINGS

See fittings page for more easy to install stem options.

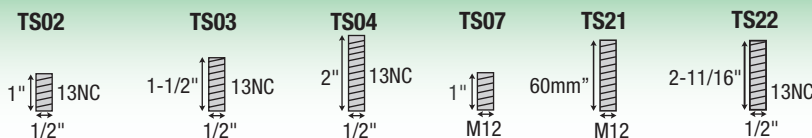

Specify Threaded Stem (TS) code, see fittings at left for dimensions:



# CHROME HOSPITAL (CH)

## THREADED STEM TOTAL LOCK MODELS (LOCKS WHEEL AND SWIVEL)

Wheel Diameter (Inches)	Tread Width (Inches)	Wheel Description	Capacity (Lbs)	Load Height Inches (mm)	Swivel Radius Inches (mm)	Wheel Bearing	Model Number
3	1-1/4	Conductive Rubber	190	4-5/16" (109)	4-1/4" (108)	Annular Ball	CH-03CRB-125-TL-_____
3	1-1/4	Thermoplastic Rubber	190	4-5/16" (109)	4-1/4" (108)	Precision Ball	CH-03TPP-125-TL-_____
3	1-1/4	Anti-Microbial TPR	190	4-5/16" (109)	4-1/4" (108)	Precision Ball	CH-03AMP-125-TL-_____
3	1-1/4	Polyurethane TPU	190	4-5/16" (109)	4-1/4" (108)	Precision Ball	CH-03PYP-125-TL-_____
4	1-1/4	Conductive Rubber	240	5-5/16" (135)	4-35/64" (115)	Annular Ball	CH-04CRB-125-TL-_____
4	1-1/4	Thermoplastic Rubber	240	5-5/16" (135)	4-35/64" (115)	Precision Ball	CH-04TPP-125-TL-_____
4	1-1/4	Anti-Microbial TPR	240	5-5/16" (135)	4-35/64" (115)	Precision Ball	CH-04AMP-125-TL-_____
4	1-1/4	Polyurethane TPU	240	5-5/16" (135)	4-35/64" (115)	Precision Ball	CH-04PYP-125-TL-_____
5	1-1/4	Conductive Rubber	260	6-5/16" (160)	4-55/64" (123)	Annular Ball	CH-05CRB-125-TL-_____
5	1-1/4	Thermoplastic Rubber	260	6-5/16" (160)	4-55/64" (123)	Precision Ball	CH-05TPP-125-TL-_____
5	1-1/4	Anti-Microbial TPR	260	6-5/16" (160)	4-55/64" (123)	Precision Ball	CH-05AMP-125-TL-_____
5	1-1/4	Polyurethane TPU	260	6-5/16" (160)	4-55/64" (123)	Precision Ball	CH-05PYP-125-TL-_____
6	1-1/4	Conductive Rubber	260	7-9/32" (185)	4-55/64" (123)	Annular Ball	CH-06CRB-125-TL-_____
6	1-1/4	Thermoplastic Rubber	260	7-9/32" (185)	4-55/64" (123)	Precision Ball	CH-06TPP-125-TL-_____
6	1-1/4	Anti-Microbial TPR	260	7-9/32" (185)	4-55/64" (123)	Precision Ball	CH-06AMP-125-TL-_____
6	1-1/4	Polyurethane TPU	260	7-9/32" (185)	4-55/64" (123)	Precision Ball	CH-06PYP-125-TL-_____



**Total Lock**  
Change "SW" to "TL". Red sticker on pedal.

## THREADED STEM DIRECTION LOCK MODELS (LOCKS SWIVEL ONLY)

Wheel Diameter (Inches)	Tread Width (Inches)	Wheel Description	Capacity (Lbs)	Load Height Inches (mm)	Swivel Radius Inches (mm)	Wheel Bearing	Model Number
3	1-1/4	Conductive Rubber	190	4-5/16" (109)	4-1/4" (108)	Annular Ball	CH-03CRB-125-DL-_____
3	1-1/4	Thermoplastic Rubber	190	4-5/16" (109)	4-1/4" (108)	Precision Ball	CH-03TPP-125-DL-_____
3	1-1/4	Anti-Microbial TPR	190	4-5/16" (109)	4-1/4" (108)	Precision Ball	CH-03AMP-125-DL-_____
3	1-1/4	Polyurethane TPU	190	4-5/16" (109)	4-1/4" (108)	Precision Ball	CH-03PYP-125-DL-_____
4	1-1/4	Conductive Rubber	240	5-5/16" (135)	4-35/64" (115)	Annular Ball	CH-04CRB-125-DL-_____
4	1-1/4	Thermoplastic Rubber	240	5-5/16" (135)	4-35/64" (115)	Precision Ball	CH-04TPP-125-DL-_____
4	1-1/4	Anti-Microbial TPR	240	5-5/16" (135)	4-35/64" (115)	Precision Ball	CH-04AMP-125-DL-_____
4	1-1/4	Polyurethane TPU	240	5-5/16" (135)	4-35/64" (115)	Precision Ball	CH-04PYP-125-DL-_____
5	1-1/4	Conductive Rubber	260	6-5/16" (160)	4-55/64" (123)	Annular Ball	CH-05CRB-125-DL-_____
5	1-1/4	Thermoplastic Rubber	260	6-5/16" (160)	4-55/64" (123)	Precision Ball	CH-05TPP-125-DL-_____
5	1-1/4	Anti-Microbial TPR	260	6-5/16" (160)	4-55/64" (123)	Precision Ball	CH-05AMP-125-DL-_____
5	1-1/4	Polyurethane TPU	260	6-5/16" (160)	4-55/64" (123)	Precision Ball	CH-05PYP-125-DL-_____
6	1-1/4	Conductive Rubber	260	7-9/32" (185)	4-55/64" (123)	Annular Ball	CH-06CRB-125-DL-_____
6	1-1/4	Thermoplastic Rubber	260	7-9/32" (185)	4-55/64" (123)	Precision Ball	CH-06TPP-125-DL-_____
6	1-1/4	Anti-Microbial TPR	260	7-9/32" (185)	4-55/64" (123)	Precision Ball	CH-06AMP-125-DL-_____
6	1-1/4	Polyurethane TPU	260	7-9/32" (185)	4-55/64" (123)	Precision Ball	CH-06PYP-125-DL-_____



**Direction Lock**  
Change "SW" to "DL". Green sticker on pedal.

Stems ship with a loose bolt for easier alignment of the directional lock.

Specify Threaded Stem (TS) code, see fittings at left for dimensions:

### THREADED STEM FITTINGS

See fittings page for more easy to install stem options.

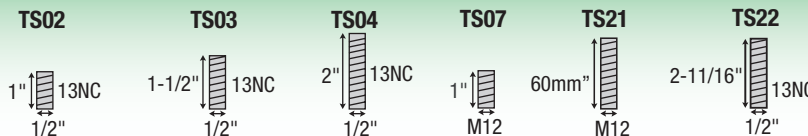

# CHROME HOSPITAL (CH)

ROUND/SQUARE STEM MODELS  
FREE SWIVEL • TOTAL LOCK • DIRECTION LOCK



## APPLICATIONS

- Food Service
- Case Carts
- Utility Carts
- Hospital Equipment
- Institutional Equipment
- Store Fixtures
- Medical equipment

New chrome thread guards now available!

## FEATURES

- Chrome Plated Finish
- Dual Ball Swivel Raceways for added strength
- **Total Lock Brake** models lock both swivel and wheel
- Directional lock models lock swivel only (helps with steering)
- Precision ball bearings in wheels for easier rollability
- Wheels have full thread guards for added protection

The CH series brings you Chrome Hospital casters at an affordable price.

## SQUARE/ROUND STEM FREE SWIVEL MODELS

Wheel Diameter (Inches)	Tread Width (Inches)	Wheel Description	Capacity (Lbs)	Load Height Inches (mm)	Swivel Radius Inches (mm)	Wheel Bearing	Model Number
3	1-1/4	Conductive Rubber	190	4-5/16" (109)	2-29/32" (74)	Annular Ball	CH-03CRB-125-SW-____
3	1-1/4	Thermoplastic Rubber	190	4-5/16" (109)	2-29/32" (74)	Precision Ball	CH-03TPP-125-SW-____
3	1-1/4	Anti-Microbial TPR	190	4-5/16" (109)	2-29/32" (74)	Precision Ball	CH-03AMP-125-SW-____
3	1-1/4	Polyurethane TPU	190	4-5/16" (109)	2-29/32" (74)	Precision Ball	CH-03PYP-125-SW-____
4	1-1/4	Conductive Rubber	240	5-5/16" (135)	3-37/64" (91)	Annular Ball	CH-04CRB-125-SW-____
4	1-1/4	Thermoplastic Rubber	240	5-5/16" (135)	3-37/64" (91)	Precision Ball	CH-04TPP-125-SW-____
4	1-1/4	Anti-Microbial TPR	240	5-5/16" (135)	3-37/64" (91)	Precision Ball	CH-04AMP-125-SW-____
4	1-1/4	Polyurethane TPU	240	5-5/16" (135)	3-37/64" (91)	Precision Ball	CH-04PYP-125-SW-____
5	1-1/4	Conductive Rubber	260	6-5/16" (160)	4-7/32" (108)	Annular Ball	CH-05CRB-125-SW-____
5	1-1/4	Thermoplastic Rubber	260	6-5/16" (160)	4-7/32" (108)	Precision Ball	CH-05TPP-125-SW-____
5	1-1/4	Anti-Microbial TPR	260	6-5/16" (160)	4-7/32" (108)	Precision Ball	CH-05AMP-125-SW-____
5	1-1/4	Polyurethane TPU	260	6-5/16" (160)	4-7/32" (108)	Precision Ball	CH-05PYP-125-SW-____
6	1-1/4	Conductive Rubber	260	7-9/32" (185)	4-39/64" (117)	Annular Ball	CH-06CRB-125-SW-____
6	1-1/4	Thermoplastic Rubber	260	7-9/32" (185)	4-39/64" (117)	Precision Ball	CH-06TPP-125-SW-____
6	1-1/4	Anti-Microbial TPR	260	7-9/32" (185)	4-39/64" (117)	Precision Ball	CH-06AMP-125-SW-____
6	1-1/4	Polyurethane TPU	260	7-9/32" (185)	4-39/64" (117)	Precision Ball	CH-06PYP-125-SW-____



Rigid models available. Consult factory.

Anti-Microbial wheels have light green tread.



To order chrome thread guard add "CTG" to end of model (Example: CH05TPP-125-SW-RS01-CTG).

Specify Round Stem (RS) code, Square stem specify (SQ) code. See fittings at left for dimensions..

### ROUND STEM FITTINGS

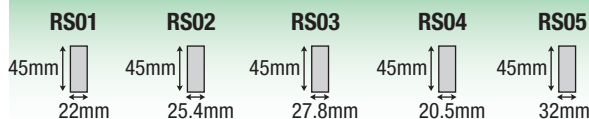

See fittings page for more options.

### SQUARE STEM FITTINGS

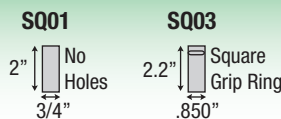

# CHROME HOSPITAL (CH)

## SQUARE/ROUND STEM TOTAL LOCK MODELS (LOCKS WHEEL AND SWIVEL)

Wheel Diameter (Inches)	Tread Width (Inches)	Wheel Description	Capacity (Lbs)	Load Height Inches (mm)	Swivel Radius Inches (mm)	Wheel Bearing	Model Number
3	1-1/4	Conductive Rubber	190	4-5/16" (109)	4-1/4" (108)	Annular Ball	CH-03CRB-125-TL-_____
3	1-1/4	Thermoplastic Rubber	190	4-5/16" (109)	4-1/4" (108)	Precision Ball	CH-03TPP-125-TL-_____
3	1-1/4	Anti-Microbial TPR	190	4-5/16" (109)	4-1/4" (108)	Precision Ball	CH-03AMP-125-TL-_____
3	1-1/4	Polyurethane TPU	190	4-5/16" (109)	4-1/4" (108)	Precision Ball	CH-03PYP-125-TL-_____
4	1-1/4	Conductive Rubber	240	5-5/16" (135)	4-35/64" (115)	Annular Ball	CH-04CRB-125-TL-_____
4	1-1/4	Thermoplastic Rubber	240	5-5/16" (135)	4-35/64" (115)	Precision Ball	CH-04TPP-125-TL-_____
4	1-1/4	Anti-Microbial TPR	240	5-5/16" (135)	4-35/64" (115)	Precision Ball	CH-04AMP-125-TL-_____
4	1-1/4	Polyurethane TPU	240	5-5/16" (135)	4-35/64" (115)	Precision Ball	CH-04PYP-125-TL-_____
5	1-1/4	Conductive Rubber	260	6-5/16" (160)	4-55/64" (123)	Annular Ball	CH-05CRB-125-TL-_____
5	1-1/4	Thermoplastic Rubber	260	6-5/16" (160)	4-55/64" (123)	Precision Ball	CH-05TPP-125-TL-_____
5	1-1/4	Anti-Microbial TPR	260	6-5/16" (160)	4-55/64" (123)	Precision Ball	CH-05AMP-125-TL-_____
5	1-1/4	Polyurethane TPU	260	6-5/16" (160)	4-55/64" (123)	Precision Ball	CH-05PYP-125-TL-_____
6	1-1/4	Conductive Rubber	260	7-9/32" (185)	4-55/64" (123)	Annular Ball	CH-06CRB-125-TL-_____
6	1-1/4	Thermoplastic Rubber	260	7-9/32" (185)	4-55/64" (123)	Precision Ball	CH-06TPP-125-TL-_____
6	1-1/4	Anti-Microbial TPR	260	7-9/32" (185)	4-55/64" (123)	Precision Ball	CH-06AMP-125-TL-_____
6	1-1/4	Polyurethane TPU	260	7-9/32" (185)	4-55/64" (123)	Precision Ball	CH-06PYP-125-TL-_____



**Total Lock**  
Change "SW" to "TL". **Red** sticker on pedal.

## SQUARE/ROUND STEM DIRECTION LOCK MODELS (LOCKS SWIVEL ONLY)

Wheel Diameter (Inches)	Tread Width (Inches)	Wheel Description	Capacity (Lbs)	Load Height Inches (mm)	Swivel Radius Inches (mm)	Wheel Bearing	Model Number
3	1-1/4	Conductive Rubber	190	4-5/16" (109)	4-1/4" (108)	Annular Ball	CH-03CRB-125-DL-_____
3	1-1/4	Thermoplastic Rubber	190	4-5/16" (109)	4-1/4" (108)	Precision Ball	CH-03TPP-125-DL-_____
3	1-1/4	Anti-Microbial TPR	190	4-5/16" (109)	4-1/4" (108)	Precision Ball	CH-03AMP-125-DL-_____
3	1-1/4	Polyurethane TPU	190	4-5/16" (109)	4-1/4" (108)	Precision Ball	CH-03PYP-125-DL-_____
4	1-1/4	Conductive Rubber	240	5-5/16" (135)	4-35/64" (115)	Annular Ball	CH-04CRB-125-DL-_____
4	1-1/4	Thermoplastic Rubber	240	5-5/16" (135)	4-35/64" (115)	Precision Ball	CH-04TPP-125-DL-_____
4	1-1/4	Anti-Microbial TPR	240	5-5/16" (135)	4-35/64" (115)	Precision Ball	CH-04AMP-125-DL-_____
4	1-1/4	Polyurethane TPU	240	5-5/16" (135)	4-35/64" (115)	Precision Ball	CH-04PYP-125-DL-_____
5	1-1/4	Conductive Rubber	260	6-5/16" (160)	4-55/64" (123)	Annular Ball	CH-05CRB-125-DL-_____
5	1-1/4	Thermoplastic Rubber	260	6-5/16" (160)	4-55/64" (123)	Precision Ball	CH-05TPP-125-DL-_____
5	1-1/4	Anti-Microbial TPR	260	6-5/16" (160)	4-55/64" (123)	Precision Ball	CH-05AMP-125-DL-_____
5	1-1/4	Polyurethane TPU	260	6-5/16" (160)	4-55/64" (123)	Precision Ball	CH-05PYP-125-DL-_____
6	1-1/4	Conductive Rubber	260	7-9/32" (185)	4-55/64" (123)	Annular Ball	CH-06CRB-125-DL-_____
6	1-1/4	Thermoplastic Rubber	260	7-9/32" (185)	4-55/64" (123)	Precision Ball	CH-06TPP-125-DL-_____
6	1-1/4	Anti-Microbial TPR	260	7-9/32" (185)	4-55/64" (123)	Precision Ball	CH-06AMP-125-DL-_____
6	1-1/4	Polyurethane TPU	260	7-9/32" (185)	4-55/64" (123)	Precision Ball	CH-06PYP-125-DL-_____



**Direction Lock**  
Change "SW" to "DL". **Green** sticker on pedal.

Stems ship with a loose bolt for easier alignment of the directional lock.

### ROUND STEM FITTINGS

<b>RS01</b>	<b>RS02</b>	<b>RS03</b>	<b>RS04</b>	<b>RS05</b>

### SQUARE STEM FITTINGS

<b>SQ01</b>	<b>SQ03</b>

Specify Round Stem (RS) code, Square stem specify (SQ) code. see fittings at left for dimensions..

# CHROME HOSPITAL (CX)

## TOP PLATE MODELS

FREE SWIVEL • TOTAL LOCK • DIRECTION LOCK

**NEW**



Thermoplastic rubber with chrome plated thread guard  
CX-05TPP-125-SW-TP13-CTG

Anti-microbial TPR wheel with total lock brake  
CX-05AMP-125-TL-TP13

- APPLICATIONS**
- Food Service
  - Case Carts
  - Utility Carts
  - Hospital Equipment
  - Institutional Equipment
  - Store Fixtures
  - Medical equipment

- FEATURES**
- Short swivel radius
  - Chrome plated finish
  - **NEW** double pedal brake design for easy on/off function for both total lock and direction lock casters
  - Dual ball heat treated raceways for added strength
  - **Total Lock Brake** models lock both swivel and wheel
  - Directional lock models lock swivel only (helps with steering)
  - Precision ball bearings in wheels for easier rollability
  - Wheels have full thread guards for added protection

The CX series brings you Chrome plated institutional casters at an affordable price.

## SWIVEL TOP PLATE MODELS

Wheel Diameter (Inches)	Tread Width (Inches)	Wheel Description	Capacity (Lbs)	Load Height Inches (mm)	Swivel Radius Inches (mm)	Wheel Bearing	Model Number
3	1-1/4	Thermoplastic Rubber	220	4-7/16" (113)	3-1/4" (83)	Precision Ball	CX-03TPP-125-SW-TP13
3	1-1/4	Anti-Microbial TPR	190	4-7/16" (113)	3-1/4" (83)	Precision Ball	CX-03AMP-125-SW-TP13
3	1-1/4	Polyurethane TPU	220	4-7/16" (113)	3-1/4" (83)	Precision Ball	CX-03PYP-125-SW-TP13
4	1-1/4	Thermoplastic Rubber	240	5-7/16" (138)	3-3/4" (95)	Precision Ball	CX-04TPP-125-SW-TP13
4	1-1/4	Anti-Microbial TPR	240	5-7/16" (138)	3-3/4" (95)	Precision Ball	CX-04AMP-125-SW-TP13
4	1-1/4	Polyurethane TPU	240	5-7/16" (138)	3-3/4" (95)	Precision Ball	CX-04PYP-125-SW-TP13
5	1-1/4	Thermoplastic Rubber	275	6-7/16" (163)	4-1/4" (108)	Precision Ball	CX-05TPP-125-SW-TP13
5	1-1/4	Anti-Microbial TPR	260	6-7/16" (163)	4-1/4" (108)	Precision Ball	CX-05AMP-125-SW-TP13
5	1-1/4	Polyurethane TPU	275	6-7/16" (163)	4-1/4" (108)	Precision Ball	CX-05PYP-125-SW-TP13
6	1-1/4	Thermoplastic Rubber	300	7-7/16" (188)	4-5/8" (117)	Precision Ball	CX-06TPP-125-SW-TP13
6	1-1/4	Anti-Microbial TPR	260	7-7/16" (188)	4-5/8" (117)	Precision Ball	CX-06AMP-125-SW-TP13
6	1-1/4	Polyurethane TPU	300	7-7/16" (188)	4-5/8" (117)	Precision Ball	CX-06PYP-125-SW-TP13



To order chrome thread guard add "CTG" to end of model (Example: CX05TPP-125-SW-TP01-CTG)

## TOP PLATE FITTING TP13

TP13 is standard plate. Other plate sizes available with minimum order quantities. Consult MedCaster.

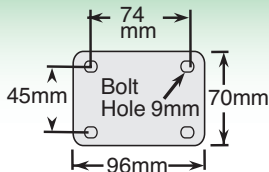

See CP Series for casters with protective covers to match your equipment (4" and 5" wheel diameter models).

# CHROME HOSPITAL (CX)

## SWIVEL TOP PLATE TOTAL LOCK MODELS

(LOCKS WHEEL AND SWIVEL)

Wheel Diameter (Inches)	Tread Width (Inches)	Wheel Description	Capacity (Lbs)	Load Height Inches (mm)	Swivel Radius Inches (mm)	Wheel Bearing	Model Number
3	1-1/4	Thermoplastic Rubber	220	4-7/16" (113)	4-1/4" (107)	Precision Ball	CX-03TPP-125-TL-TP13
3	1-1/4	Anti-Microbial TPR	190	4-7/16" (113)	4-1/4" (107)	Precision Ball	CX-03AMP-125-TL-TP13
3	1-1/4	Polyurethane TPU	220	4-7/16" (113)	4-1/4" (107)	Precision Ball	CX-03PYP-125-TL-TP13
4	1-1/4	Thermoplastic Rubber	240	5-7/16" (138)	4-3/16" (106)	Precision Ball	CX-04TPP-125-TL-TP13
4	1-1/4	Anti-Microbial TPR	240	5-7/16" (138)	4-3/16" (106)	Precision Ball	CX-04AMP-125-TL-TP13
4	1-1/4	Polyurethane TPU	240	5-7/16" (138)	4-3/16" (106)	Precision Ball	CX-04PYP-125-TL-TP13
5	1-1/4	Thermoplastic Rubber	275	6-7/16" (163)	4-5/16" (109)	Precision Ball	CX-05TPP-125-TL-TP13
5	1-1/4	Anti-Microbial TPR	260	6-7/16" (163)	4-5/16" (109)	Precision Ball	CX-05AMP-125-TL-TP13
5	1-1/4	Polyurethane TPU	275	6-7/16" (163)	4-5/16" (109)	Precision Ball	CX-05PYP-125-TL-TP13
6	1-1/4	Thermoplastic Rubber	300	7-7/16" (188)	4-3/4" (119)	Precision Ball	CX-06TPP-125-TL-TP13
6	1-1/4	Anti-Microbial TPR	260	7-7/16" (188)	4-3/4" (119)	Precision Ball	CX-06AMP-125-TL-TP13
6	1-1/4	Polyurethane TPU	300	7-7/16" (188)	4-3/4" (119)	Precision Ball	CX-06PYP-125-TL-TP13



**Total Lock**  
Red pedal.

## SWIVEL TOP PLATE DIRECTION LOCK MODELS

(LOCKS SWIVEL ONLY)

Wheel Diameter (Inches)	Tread Width (Inches)	Wheel Description	Capacity (Lbs)	Load Height Inches (mm)	Swivel Radius Inches (mm)	Wheel Bearing	Model Number
3	1-1/4	Thermoplastic Rubber	220	4-7/16" (113)	4-1/4" (107)	Precision Ball	CX-03TPP-125-DL-TP13
3	1-1/4	Anti-Microbial TPR	190	4-7/16" (113)	4-1/4" (107)	Precision Ball	CX-03AMP-125-DL-TP13
3	1-1/4	Polyurethane TPU	220	4-7/16" (113)	4-1/4" (107)	Precision Ball	CX-03PYP-125-DL-TP13
4	1-1/4	Thermoplastic Rubber	240	5-7/16" (138)	4-3/16" (106)	Precision Ball	CX-04TPP-125-DL-TP13
4	1-1/4	Anti-Microbial TPR	240	5-7/16" (138)	4-3/16" (106)	Precision Ball	CX-04AMP-125-DL-TP13
4	1-1/4	Polyurethane TPU	240	5-7/16" (138)	4-3/16" (106)	Precision Ball	CX-04PYP-125-DL-TP13
5	1-1/4	Thermoplastic Rubber	275	6-7/16" (163)	4-5/16" (109)	Precision Ball	CX-05TPP-125-DL-TP13
5	1-1/4	Anti-Microbial TPR	260	6-7/16" (163)	4-5/16" (109)	Precision Ball	CX-05AMP-125-DL-TP13
5	1-1/4	Polyurethane TPU	275	6-7/16" (163)	4-5/16" (109)	Precision Ball	CX-05PYP-125-DL-TP13
6	1-1/4	Thermoplastic Rubber	300	7-7/16" (188)	4-3/4" (119)	Precision Ball	CX-06TPP-125-DL-TP13
6	1-1/4	Anti-Microbial TPR	260	7-7/16" (188)	4-3/4" (119)	Precision Ball	CX-06AMP-125-DL-TP13
6	1-1/4	Polyurethane TPU	300	7-7/16" (188)	4-3/4" (119)	Precision Ball	CX-06PYP-125-DL-TP13



**Direction Lock**  
Green pedal.

## TOP PLATE FITTING TP13

TP13 is standard plate. Other plate sizes available with minimum order quantities. Consult MedCaster.

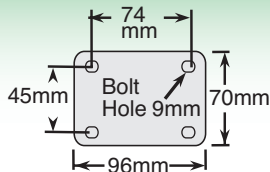

# CHROME HOSPITAL (CX)

## SWIVEL HOLLOW KINGPIN MODELS

FREE SWIVEL • TOTAL LOCK • DIRECTION LOCK

**NEW**



Thermoplastic rubber wheel  
CX-05TPP-125-SW-HK01



Polyurethane TPU wheel with direction lock  
CX-05PYP-125-DL-HK01

### APPLICATIONS

- Food Service
- Case Carts
- Utility Carts
- Hospital Equipment
- Institutional Equipment
- Store Fixtures
- Medical equipment

### FEATURES

- Short swivel radius
- Chrome plated finish
- **NEW** double pedal brake design for easy on/off function for both total lock and direction lock casters
- Dual ball heat treated raceways for added strength
- **Total Lock Brake** models lock both swivel and wheel
- Directional lock models lock swivel only (helps with steering)
- Precision ball bearings in wheels for easier rollability
- Wheels have full thread guards for added protection

The CX series brings you chrome plated institutional casters at an affordable price.

## SWIVEL HOLLOW KINGPIN MODELS

Wheel Diameter (Inches)	Tread Width (Inches)	Wheel Description	Capacity (Lbs)	Load Height Inches (mm)	Swivel Radius Inches (mm)	Wheel Bearing	Model Number
3	1-1/4	Thermoplastic Rubber	220	4-5/16" (109)	3-1/4" (83)	Precision Ball	CX-03TPP-125-SW-HK01
3	1-1/4	Anti-Microbial TPR	190	4-5/16" (109)	3-1/4" (83)	Precision Ball	CX-03AMP-125-SW-HK01
3	1-1/4	Polyurethane TPU	220	4-5/16" (109)	3-1/4" (83)	Precision Ball	CX-03PYP-125-SW-HK01
4	1-1/4	Thermoplastic Rubber	240	5-5/16" (135)	3-3/4" (95)	Precision Ball	CX-04TPP-125-SW-HK01
4	1-1/4	Anti-Microbial TPR	240	5-5/16" (135)	3-3/4" (95)	Precision Ball	CX-04AMP-125-SW-HK01
4	1-1/4	Polyurethane TPU	240	5-5/16" (135)	3-3/4" (95)	Precision Ball	CX-04PYP-125-SW-HK01
5	1-1/4	Thermoplastic Rubber	275	6-5/16" (160)	4-1/4" (108)	Precision Ball	CX-05TPP-125-SW-HK01
5	1-1/4	Anti-Microbial TPR	260	6-5/16" (160)	4-1/4" (108)	Precision Ball	CX-05AMP-125-SW-HK01
5	1-1/4	Polyurethane TPU	275	6-5/16" (160)	4-1/4" (108)	Precision Ball	CX-05PYP-125-SW-HK01
6	1-1/4	Thermoplastic Rubber	300	7-9/32" (185)	4-5/8 (117)	Precision Ball	CX-06TPP-125-SW-HK01
6	1-1/4	Anti-Microbial TPR	260	7-9/32" (185)	4-5/8 (117)	Precision Ball	CX-06AMP-125-SW-HK01
6	1-1/4	Polyurethane TPU	300	7-9/32" (185)	4-5/8 (117)	Precision Ball	CX-06PYP-125-SW-HK01



To order chrome thread guard add "CTG" to end of model (Example: CX05TPP-125-SW-HK01-CTG)

## HOLLOW KINGPIN

Caster is **provided assembled**. If you will be using your choice of fitting and would like these casters unassembled, change suffix to **HKU1**. 1/2 I.D.



# CHROME HOSPITAL (CX)

## SWIVEL HOLLOW KINGPIN TOTAL LOCK MODELS (LOCKS WHEEL AND SWIVEL)

Wheel Diameter (Inches)	Tread Width (Inches)	Wheel Description	Capacity (Lbs)	Load Height Inches (mm)	Swivel Radius Inches (mm)	Wheel Bearing	Model Number
3	1-1/4	Thermoplastic Rubber	220	4-5/16" (109)	4-1/4" (107)	Precision Ball	CX-03TPP-125-TL-HK01
3	1-1/4	Anti-Microbial TPR	190	4-5/16" (109)	4-1/4" (107)	Precision Ball	CX-03AMP-125-TL-HK01
3	1-1/4	Polyurethane TPU	220	4-5/16" (109)	4-1/4" (107)	Precision Ball	CX-03PYP-125-TL-HK01
4	1-1/4	Thermoplastic Rubber	240	5-5/16" (135)	4-3/16" (106)	Precision Ball	CX-04TPP-125-TL-HK01
4	1-1/4	Anti-Microbial TPR	240	5-5/16" (135)	4-3/16" (106)	Precision Ball	CX-04AMP-125-TL-HK01
4	1-1/4	Polyurethane TPU	240	5-5/16" (135)	4-3/16" (106)	Precision Ball	CX-04PYP-125-TL-HK01
5	1-1/4	Thermoplastic Rubber	275	6-5/16" (160)	4-5/16" (109)	Precision Ball	CX-05TPP-125-TL-HK01
5	1-1/4	Anti-Microbial TPR	260	6-5/16" (160)	4-5/16" (109)	Precision Ball	CX-05AMP-125-TL-HK01
5	1-1/4	Polyurethane TPU	275	6-5/16" (160)	4-5/16" (109)	Precision Ball	CX-05PYP-125-TL-HK01
6	1-1/4	Thermoplastic Rubber	300	7-9/32" (185)	4-3/4" (119)	Precision Ball	CX-06TPP-125-TL-HK01
6	1-1/4	Anti-Microbial TPR	260	7-9/32" (185)	4-3/4" (119)	Precision Ball	CX-06AMP-125-TL-HK01
6	1-1/4	Polyurethane TPU	300	7-9/32" (185)	4-3/4" (119)	Precision Ball	CX-06PYP-125-TL-HK01



**Total Lock**  
Red pedal.

## SWIVEL HOLLOW KINGPIN DIRECTION LOCK MODELS (LOCKS SWIVEL ONLY)

Wheel Diameter (Inches)	Tread Width (Inches)	Wheel Description	Capacity (Lbs)	Load Height Inches (mm)	Swivel Radius Inches (mm)	Wheel Bearing	Model Number
3	1-1/4	Thermoplastic Rubber	220	4-5/16" (109)	4-1/4" (107)	Precision Ball	CX-03TPP-125-DL-HK01
3	1-1/4	Anti-Microbial TPR	190	4-5/16" (109)	4-1/4" (107)	Precision Ball	CX-03AMP-125-DL-HK01
3	1-1/4	Polyurethane TPU	220	4-5/16" (109)	4-1/4" (107)	Precision Ball	CX-03PYP-125-DL-HK01
4	1-1/4	Thermoplastic Rubber	240	5-5/16" (135)	4-3/16" (106)	Precision Ball	CX-04TPP-125-DL-HK01
4	1-1/4	Anti-Microbial TPR	240	5-5/16" (135)	4-3/16" (106)	Precision Ball	CX-04AMP-125-DL-HK01
4	1-1/4	Polyurethane TPU	240	5-5/16" (135)	4-3/16" (106)	Precision Ball	CX-04PYP-125-DL-HK01
5	1-1/4	Thermoplastic Rubber	275	6-5/16" (160)	4-5/16" (109)	Precision Ball	CX-05TPP-125-DL-HK01
5	1-1/4	Anti-Microbial TPR	260	6-5/16" (160)	4-5/16" (109)	Precision Ball	CX-05AMP-125-DL-HK01
5	1-1/4	Polyurethane TPU	275	6-5/16" (160)	4-5/16" (109)	Precision Ball	CX-05PYP-125-DL-HK01
6	1-1/4	Thermoplastic Rubber	300	7-9/32" (185)	4-3/4" (119)	Precision Ball	CX-06TPP-125-DL-HK01
6	1-1/4	Anti-Microbial TPR	260	7-9/32" (185)	4-3/4" (119)	Precision Ball	CX-06AMP-125-DL-HK01
6	1-1/4	Polyurethane TPU	300	7-9/32" (185)	4-3/4" (119)	Precision Ball	CX-06PYP-125-DL-HK01



**Direction Lock**  
Green pedal.

### HOLLOW KINGPIN

Caster is **provided assembled**. If you will be using your choice of fitting and would like these casters unassembled, change suffix to **HKU1**. 1/2 I.D.



# CHROME HOSPITAL (CX)

## THREADED STEM MODELS

FREE SWIVEL • TOTAL LOCK • DIRECTION LOCK

**NEW**



Polyurethane TPU wheel  
CX-05PYP-125-SW-TS02



Anti-microbial TPR wheel with total lock  
CX-05AMP-125-TL-TS02

### APPLICATIONS

- Food Service
- Case Carts
- Utility Carts
- Hospital Equipment
- Institutional Equipment
- Store Fixtures
- Medical equipment

### FEATURES

- Short swivel radius
- Chrome plated finish
- **NEW** double pedal brake design for easy on/off function for both total lock and direction lock casters
- Dual ball heat treated raceways for added strength
- **Total Lock Brake** models lock both swivel and wheel
- Directional lock models lock swivel only (helps with steering)
- Precision ball bearings in wheels for easier rollability
- Wheels have full thread guards for added protection

The CX series brings you chrome plated institutional casters at an affordable price.

## THREADED STEM MODELS

Wheel Diameter (Inches)	Tread Width (Inches)	Wheel Description	Capacity (Lbs)	Load Height Inches (mm)	Swivel Radius Inches (mm)	Wheel Bearing	Model Number
3	1-1/4	Thermoplastic Rubber	220	4-5/16" (109)	3-1/4" (83)	Precision Ball	CX-03TPP-125-SW-TS02
3	1-1/4	Anti-Microbial TPR	190	4-5/16" (109)	3-1/4" (83)	Precision Ball	CX-03AMP-125-SW-TS02
3	1-1/4	Polyurethane TPU	220	4-5/16" (109)	3-1/4" (83)	Precision Ball	CX-03PYP-125-SW-TS02
4	1-1/4	Thermoplastic Rubber	240	5-5/16" (135)	3-3/4" (95)	Precision Ball	CX-04TPP-125-SW-TS02
4	1-1/4	Anti-Microbial TPR	240	5-5/16" (135)	3-3/4" (95)	Precision Ball	CX-04AMP-125-SW-TS02
4	1-1/4	Polyurethane TPU	240	5-5/16" (135)	3-3/4" (95)	Precision Ball	CX-04PYP-125-SW-TS02
5	1-1/4	Thermoplastic Rubber	275	6-5/16" (160)	4-1/4" (108)	Precision Ball	CX-05TPP-125-SW-TS02
5	1-1/4	Anti-Microbial TPR	260	6-5/16" (160)	4-1/4" (108)	Precision Ball	CX-05AMP-125-SW-TS02
5	1-1/4	Polyurethane TPU	275	6-5/16" (160)	4-1/4" (108)	Precision Ball	CX-05PYP-125-SW-TS02
6	1-1/4	Thermoplastic Rubber	300	7-9/32" (185)	4-5/8 (117)	Precision Ball	CX-06TPP-125-SW-TS02
6	1-1/4	Anti-Microbial TPR	260	7-9/32" (185)	4-5/8 (117)	Precision Ball	CX-06AMP-125-SW-TS02
6	1-1/4	Polyurethane TPU	300	7-9/32" (185)	4-5/8 (117)	Precision Ball	CX-06PYP-125-SW-TS02



To order chrome thread guard add "CTG" to end of model  
(Example:  
CX05TPP-125-SW-TS02-CTG)

## THREADED STEM FITTINGS

TS02



See CP Series for casters with protective covers to match your equipment (4" and 5" wheel diameter models).



# CHROME HOSPITAL (CX)

## THREADED STEM TOTAL LOCK MODELS (LOCKS WHEEL AND SWIVEL)

Wheel Diameter (Inches)	Tread Width (Inches)	Wheel Description	Capacity (Lbs)	Load Height Inches (mm)	Swivel Radius Inches (mm)	Wheel Bearing	Model Number
3	1-1/4	Thermoplastic Rubber	220	4-5/16" (109)	4-1/4" (107)	Precision Ball	CX-03TPP-125-TL-TS02
3	1-1/4	Anti-Microbial TPR	190	4-5/16" (109)	4-1/4" (107)	Precision Ball	CX-03AMP-125-TL-TS02
3	1-1/4	Polyurethane TPU	220	4-5/16" (109)	4-1/4" (107)	Precision Ball	CX-03PYP-125-TL-TS02
4	1-1/4	Thermoplastic Rubber	240	5-5/16" (135)	4-3/16" (106)	Precision Ball	CX-04TPP-125-TL-TS02
4	1-1/4	Anti-Microbial TPR	240	5-5/16" (135)	4-3/16" (106)	Precision Ball	CX-04AMP-125-TL-TS02
4	1-1/4	Polyurethane TPU	240	5-5/16" (135)	4-3/16" (106)	Precision Ball	CX-04PYP-125-TL-TS02
5	1-1/4	Thermoplastic Rubber	275	6-5/16" (160)	4-5/16" (109)	Precision Ball	CX-05TPP-125-TL-TS02
5	1-1/4	Anti-Microbial TPR	260	6-5/16" (160)	4-5/16" (109)	Precision Ball	CX-05AMP-125-TL-TS02
5	1-1/4	Polyurethane TPU	275	6-5/16" (160)	4-5/16" (109)	Precision Ball	CX-05PYP-125-TL-TS02
6	1-1/4	Thermoplastic Rubber	300	7-9/32" (185)	4-3/4" (119)	Precision Ball	CX-06TPP-125-TL-TS02
6	1-1/4	Anti-Microbial TPR	260	7-9/32" (185)	4-3/4" (119)	Precision Ball	CX-06AMP-125-TL-TS02
6	1-1/4	Polyurethane TPU	300	7-9/32" (185)	4-3/4" (119)	Precision Ball	CX-06PYP-125-TL-TS02



**Total Lock**  
Red pedal.

## THREADED STEM DIRECTION LOCK MODELS (LOCKS SWIVEL ONLY)

Wheel Diameter (Inches)	Tread Width (Inches)	Wheel Description	Capacity (Lbs)	Load Height Inches (mm)	Swivel Radius Inches (mm)	Wheel Bearing	Model Number
3	1-1/4	Thermoplastic Rubber	220	4-5/16" (109)	4-1/4" (107)	Precision Ball	CX-03TPP-125-DL-TS02
3	1-1/4	Anti-Microbial TPR	190	4-5/16" (109)	4-1/4" (107)	Precision Ball	CX-03AMP-125-DL-TS02
3	1-1/4	Polyurethane TPU	220	4-5/16" (109)	4-1/4" (107)	Precision Ball	CX-03PYP-125-DL-TS02
4	1-1/4	Thermoplastic Rubber	240	5-5/16" (135)	4-3/16" (106)	Precision Ball	CX-04TPP-125-DL-TS02
4	1-1/4	Anti-Microbial TPR	240	5-5/16" (135)	4-3/16" (106)	Precision Ball	CX-04AMP-125-DL-TS02
4	1-1/4	Polyurethane TPU	240	5-5/16" (135)	4-3/16" (106)	Precision Ball	CX-04PYP-125-DL-TS02
5	1-1/4	Thermoplastic Rubber	275	6-5/16" (160)	4-5/16" (109)	Precision Ball	CX-05TPP-125-DL-TS02
5	1-1/4	Anti-Microbial TPR	260	6-5/16" (160)	4-5/16" (109)	Precision Ball	CX-05AMP-125-DL-TS02
5	1-1/4	Polyurethane TPU	275	6-5/16" (160)	4-5/16" (109)	Precision Ball	CX-05PYP-125-DL-TS02
6	1-1/4	Thermoplastic Rubber	300	7-9/32" (185)	4-3/4" (119)	Precision Ball	CX-06TPP-125-DL-TS02
6	1-1/4	Anti-Microbial TPR	260	7-9/32" (185)	4-3/4" (119)	Precision Ball	CX-06AMP-125-DL-TS02
6	1-1/4	Polyurethane TPU	300	7-9/32" (185)	4-3/4" (119)	Precision Ball	CX-06PYP-125-DL-TS02



**Direction Lock**  
Green pedal.

Stems ship with a loose bolt for easier alignment of the directional lock.

## THREADED STEM FITTINGS

TS02



# NYLON COVERED HOSPITAL (CP)

## TOP PLATE MODELS

FREE SWIVEL • TOTAL LOCK • DIRECTION LOCK



Free swivel model  
CP-05PYP-125-SW-TP13G



Total lock model  
CP-05PYP-125-TL-TP13W

- APPLICATIONS**
- Food Service
  - Case Carts
  - Utility Carts
  - Hospital Equipment
  - Institutional Equipment
  - Store Fixtures
  - Medical equipment

- FEATURES**
- Nylon covered hospital casters
  - **NEW** double pedal brake design for easy on/off function for both total lock and direction lock casters
  - Dual ball heat treated raceways for added strength
  - **Total Lock Brake** models lock both swivel and wheel
  - Directional lock models lock swivel only (helps with steering)
  - Precision ball bearings in wheels for easier rollability
  - Wheels have full thread guards for added protection

The CP series feature nylon covered casters.

## SWIVEL TOP PLATE MODELS

WHITE NYLON COVER

Wheel Diameter (Inches)	Tread Width (Inches)	Wheel Description	Capacity (Lbs)	Load Height Inches (mm)	Swivel Radius Inches (mm)	Wheel Bearing	Model Number
4	1-1/4	Thermoplastic Rubber	240	5-7/16" (138)	3-3/4" (95)	Precision Ball	CP-04TPP-125-SW-TP13W
4	1-1/4	Anti-Microbial TPR	240	5-7/16" (138)	3-3/4" (95)	Precision Ball	CP-04AMP-125-SW-TP13W
4	1-1/4	Polyurethane TPU	240	5-7/16" (138)	3-3/4" (95)	Precision Ball	CP-04PYP-125-SW-TP13W
5	1-1/4	Thermoplastic Rubber	275	6-7/16" (163)	4-1/4" (108)	Precision Ball	CP-05TPP-125-SW-TP13W
5	1-1/4	Anti-Microbial TPR	260	6-7/16" (163)	4-1/4" (108)	Precision Ball	CP-05AMP-125-SW-TP13W
5	1-1/4	Polyurethane TPU	275	6-7/16" (163)	4-1/4" (108)	Precision Ball	CP-05PYP-125-SW-TP13W



GREY NYLON COVER

4	1-1/4	Thermoplastic Rubber	240	5-7/16" (138)	3-3/4" (95)	Precision Ball	CP-04TPP-125-SW-TP13G
4	1-1/4	Anti-Microbial TPR	240	5-7/16" (138)	3-3/4" (95)	Precision Ball	CP-04AMP-125-SW-TP13G
4	1-1/4	Polyurethane TPU	240	5-7/16" (138)	3-3/4" (95)	Precision Ball	CP-04PYP-125-SW-TP13G
5	1-1/4	Thermoplastic Rubber	275	6-7/16" (163)	4-1/4" (108)	Precision Ball	CP-05TPP-125-SW-TP13G
5	1-1/4	Anti-Microbial TPR	260	6-7/16" (163)	4-1/4" (108)	Precision Ball	CP-05AMP-125-SW-TP13G
5	1-1/4	Polyurethane TPU	275	6-7/16" (163)	4-1/4" (108)	Precision Ball	CP-05PYP-125-SW-TP13G



## TOP PLATE FITTING TP13

Swivel Top Plate Pattern

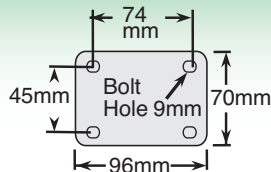

Custom colors available.  
Consult MedCaster.

# NYLON COVERED HOSPITAL (CP)

## SWIVEL TOP PLATE TOTAL LOCK MODELS (LOCKS WHEEL AND SWIVEL)

### WHITE NYLON COVER

Wheel Diameter (Inches)	Tread Width (Inches)	Wheel Description	Capacity (Lbs)	Load Height Inches (mm)	Swivel Radius Inches (mm)	Wheel Bearing	Model Number
4	1-1/4	Thermoplastic Rubber	240	5-7/16" (138)	4-3/16" (106)	Precision Ball	CP-04TPP-125-TL-TP13W
4	1-1/4	Anti-Microbial TPR	240	5-7/16" (138)	4-3/16" (106)	Precision Ball	CP-04AMP-125-TL-TP13W
4	1-1/4	Polyurethane TPU	240	5-7/16" (138)	4-3/16" (106)	Precision Ball	CP-04PYP-125-TL-TP13W
5	1-1/4	Thermoplastic Rubber	275	6-7/16" (163)	4-5/16" (109)	Precision Ball	CP-05TPP-125-TL-TP13W
5	1-1/4	Anti-Microbial TPR	260	6-7/16" (163)	4-5/16" (109)	Precision Ball	CP-05AMP-125-TL-TP13W
5	1-1/4	Polyurethane TPU	275	6-7/16" (163)	4-5/16" (109)	Precision Ball	CP-05PYP-125-TL-TP13W



Total Lock Red pedal.

### GREY NYLON COVER

4	1-1/4	Thermoplastic Rubber	240	5-7/16" (138)	4-3/16" (106)	Precision Ball	CP-04TPP-125-TL-TP13G
4	1-1/4	Anti-Microbial TPR	240	5-7/16" (138)	4-3/16" (106)	Precision Ball	CP-04AMP-125-TL-TP13G
4	1-1/4	Polyurethane TPU	242	5-7/16" (138)	4-3/16" (106)	Precision Ball	CP-04PYP-125-TL-TP13G
5	1-1/4	Thermoplastic Rubber	275	6-7/16" (163)	4-5/16" (109)	Precision Ball	CP-05TPP-125-TL-TP13G
5	1-1/4	Anti-Microbial TPR	260	6-7/16" (163)	4-5/16" (109)	Precision Ball	CP-05AMP-125-TL-TP13G
5	1-1/4	Polyurethane TPU	275	6-7/16" (163)	4-5/16" (109)	Precision Ball	CP-05PYP-125-TL-TP13G



Total Lock Red pedal.

## SWIVEL TOP PLATE DIRECTION LOCK MODELS (LOCKS SWIVEL ONLY)

### WHITE NYLON COVER

Wheel Diameter (Inches)	Tread Width (Inches)	Wheel Description	Capacity (Lbs)	Load Height Inches (mm)	Swivel Radius Inches (mm)	Wheel Bearing	Model Number
4	1-1/4	Thermoplastic Rubber	240	5-7/16" (138)	4-3/16" (106)	Precision Ball	CP-04TPP-125-DL-TP13W
4	1-1/4	Anti-Microbial TPR	240	5-7/16" (138)	4-3/16" (106)	Precision Ball	CP-04AMP-125-DL-TP13W
4	1-1/4	Polyurethane TPU	240	5-7/16" (138)	4-3/16" (106)	Precision Ball	CP-04PYP-125-DL-TP13W
5	1-1/4	Thermoplastic Rubber	275	6-7/16" (163)	4-5/16" (109)	Precision Ball	CP-05TPP-125-DL-TP13W
5	1-1/4	Anti-Microbial TPR	260	6-7/16" (163)	4-5/16" (109)	Precision Ball	CP-05AMP-125-DL-TP13W
5	1-1/4	Polyurethane TPU	275	6-7/16" (163)	4-5/16" (109)	Precision Ball	CP-05PYP-125-DL-TP13W



Direction Lock Green pedal.

### GREY NYLON COVER

4	1-1/4	Thermoplastic Rubber	240	5-7/16" (138)	4-3/16" (106)	Precision Ball	CP-04TPP-125-DL-TP13G
4	1-1/4	Anti-Microbial TPR	240	5-7/16" (138)	4-3/16" (106)	Precision Ball	CP-04AMP-125-DL-TP13G
4	1-1/4	Polyurethane TPU	240	5-7/16" (138)	4-3/16" (106)	Precision Ball	CP-04PYP-125-DL-TP13G
5	1-1/4	Thermoplastic Rubber	275	6-7/16" (163)	4-5/16" (109)	Precision Ball	CP-05TPP-125-DL-TP13G
5	1-1/4	Anti-Microbial TPR	260	6-7/16" (163)	4-5/16" (109)	Precision Ball	CP-05AMP-125-DL-TP13G
5	1-1/4	Polyurethane TPU	275	6-7/16" (163)	4-5/16" (109)	Precision Ball	CP-05PYP-125-DL-TP13G



Direction Lock Green pedal.

## TOP PLATE FITTING TP13

Swivel Top Plate Pattern

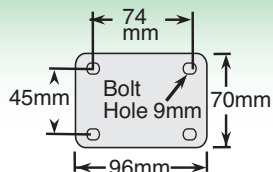

# NYLON COVERED HOSPITAL (CP)

HOLLOW KINGPIN MODELS  
FREE SWIVEL • TOTAL LOCK • DIRECTION LOCK



Free swivel model  
CP-05PYP-125-SW-TS02G



Total lock model  
CP-05PYP-125-TL-TS02W

- APPLICATIONS**
- Food Service
  - Case Carts
  - Utility Carts
  - Hospital Equipment
  - Institutional Equipment
  - Store Fixtures
  - Medical equipment

- FEATURES**
- Nylon covered hospital casters
  - **NEW** double pedal brake design for easy on/off function for both total lock and direction lock casters
  - Dual ball heat treated raceways for added strength
  - **Total Lock Brake** models lock both swivel and wheel
  - Directional lock models lock swivel only (helps with steering)
  - Precision ball bearings in wheels for easier rollability
  - Wheels have full thread guards for added protection

The CP series feature nylon covered casters.

## THREADED STEM MODELS

WHITE NYLON COVER

Wheel Diameter (Inches)	Tread Width (Inches)	Wheel Description	Capacity (Lbs)	Load Height Inches (mm)	Swivel Radius Inches (mm)	Wheel Bearing	Model Number
4	1-1/4	Thermoplastic Rubber	240	5-5/16" (135)	3-3/4" (95)	Precision Ball	CP-04TPP-125-SW-TS02W
4	1-1/4	Anti-Microbial TPR	240	5-5/16" (135)	3-3/4" (95)	Precision Ball	CP-04AMP-125-SW-TS02W
4	1-1/4	Polyurethane TPU	240	5-5/16" (135)	3-3/4" (95)	Precision Ball	CP-04PYP-125-SW-TS02W
5	1-1/4	Thermoplastic Rubber	275	6-5/16" (160)	4-1/4" (108)	Precision Ball	CP-05TPP-125-SW-TS02W
5	1-1/4	Anti-Microbial TPR	260	6-5/16" (160)	4-1/4" (108)	Precision Ball	CP-05AMP-125-SW-TS02W
5	1-1/4	Polyurethane TPU	275	6-5/16" (160)	4-1/4" (108)	Precision Ball	CP-05PYP-125-SW-TS02W



GREY NYLON COVER

4	1-1/4	Thermoplastic Rubber	240	5-5/16" (135)	3-3/4" (95)	Precision Ball	CP-04TPP-125-SW-TS02G
4	1-1/4	Anti-Microbial TPR	240	5-5/16" (135)	3-3/4" (95)	Precision Ball	CP-04AMP-125-SW-TS02G
4	1-1/4	Polyurethane TPU	240	5-5/16" (135)	3-3/4" (95)	Precision Ball	CP-04PYP-125-SW-TS02G
5	1-1/4	Thermoplastic Rubber	275	6-5/16" (160)	4-1/4" (108)	Precision Ball	CP-05TPP-125-SW-TS02G
5	1-1/4	Anti-Microbial TPR	260	6-5/16" (160)	4-1/4" (108)	Precision Ball	CP-05AMP-125-SW-TS02G
5	1-1/4	Polyurethane TPU	275	6-5/16" (160)	4-1/4" (108)	Precision Ball	CP-05PYP-125-SW-TS02G



## THREADED STEM FITTINGS

TS02



# NYLON COVERED HOSPITAL (CP)

## THREADED STEM TOTAL LOCK MODELS (LOCKS WHEEL AND SWIVEL)

### WHITE NYLON COVER

Wheel Diameter (Inches)	Tread Width (Inches)	Wheel Description	Capacity (Lbs)	Load Height Inches (mm)	Swivel Radius Inches (mm)	Wheel Bearing	Model Number
4	1-1/4	Thermoplastic Rubber	240	5-5/16" (135)	4-3/16" (106)	Precision Ball	CP-04TPP-125-TL-TS02W
4	1-1/4	Anti-Microbial TPR	240	5-5/16" (135)	4-3/16" (106)	Precision Ball	CP-04AMP-125-TL-TS02W
4	1-1/4	Polyurethane TPU	240	5-5/16" (135)	4-3/16" (106)	Precision Ball	CP-04PYP-125-TL-TS02W
5	1-1/4	Thermoplastic Rubber	275	6-5/16" (160)	4-5/16" (109)	Precision Ball	CP-05TPP-125-TL-TS02W
5	1-1/4	Anti-Microbial TPR	260	6-5/16" (160)	4-5/16" (109)	Precision Ball	CP-05AMP-125-TL-TS02W
5	1-1/4	Polyurethane TPU	275	6-5/16" (160)	4-5/16" (109)	Precision Ball	CP-05PYP-125-TL-TS02W



**Total Lock**  
Red pedal.

### GREY NYLON COVER

4	1-1/4	Thermoplastic Rubber	240	5-5/16" (135)	4-3/16" (106)	Precision Ball	CP-04TPP-125-TL-TS02G
4	1-1/4	Anti-Microbial TPR	240	5-5/16" (135)	4-3/16" (106)	Precision Ball	CP-04AMP-125-TL-TS02G
4	1-1/4	Polyurethane TPU	240	5-5/16" (135)	4-3/16" (106)	Precision Ball	CP-04PYP-125-TL-TS02G
5	1-1/4	Thermoplastic Rubber	275	6-5/16" (160)	4-5/16" (109)	Precision Ball	CP-05TPP-125-TL-TS02G
5	1-1/4	Anti-Microbial TPR	260	6-5/16" (160)	4-5/16" (109)	Precision Ball	CP-05AMP-125-TL-TS02G
5	1-1/4	Polyurethane TPU	275	6-5/16" (160)	4-5/16" (109)	Precision Ball	CP-05PYP-125-TL-TS02G



**Total Lock**  
Red pedal.

## THREADED STEM DIRECTION LOCK MODELS (LOCKS SWIVEL ONLY)

### WHITE NYLON COVER

Wheel Diameter (Inches)	Tread Width (Inches)	Wheel Description	Capacity (Lbs)	Load Height Inches (mm)	Swivel Radius Inches (mm)	Wheel Bearing	Model Number
4	1-1/4	Thermoplastic Rubber	240	5-5/16" (135)	4-3/16" (106)	Precision Ball	CP-04TPP-125-DL-TS02W
4	1-1/4	Anti-Microbial TPR	240	5-5/16" (135)	4-3/16" (106)	Precision Ball	CP-04AMP-125-DL-TS02W
4	1-1/4	Polyurethane TPU	240	5-5/16" (135)	4-3/16" (106)	Precision Ball	CP-04PYP-125-DL-TS02W
5	1-1/4	Thermoplastic Rubber	275	6-5/16" (160)	4-5/16" (109)	Precision Ball	CP-05TPP-125-DL-TS02W
5	1-1/4	Anti-Microbial TPR	260	6-5/16" (160)	4-5/16" (109)	Precision Ball	CP-05AMP-125-DL-TS02W
5	1-1/4	Polyurethane TPU	275	6-5/16" (160)	4-5/16" (109)	Precision Ball	CP-05PYP-125-DL-TS02W



**Direction Lock**  
Green pedal.

### GREY NYLON COVER

4	1-1/4	Thermoplastic Rubber	240	5-5/16" (135)	4-3/16" (106)	Precision Ball	CP-04TPP-125-DL-TS02G
4	1-1/4	Anti-Microbial TPR	240	5-5/16" (135)	4-3/16" (106)	Precision Ball	CP-04AMP-125-DL-TS02G
4	1-1/4	Polyurethane TPU	240	5-5/16" (135)	4-3/16" (106)	Precision Ball	CP-04PYP-125-DL-TS02G
5	1-1/4	Thermoplastic Rubber	275	6-5/16" (160)	4-5/16" (109)	Precision Ball	CP-05TPP-125-DL-TS02G
5	1-1/4	Anti-Microbial TPR	260	6-5/16" (160)	4-5/16" (109)	Precision Ball	CP-05AMP-125-DL-TS02G
5	1-1/4	Polyurethane TPU	275	6-5/16" (160)	4-5/16" (109)	Precision Ball	CP-05PYP-125-DL-TS02G



**Direction Lock**  
Green pedal.

Stems ship with a loose bolt for easier alignment of the directional lock.

## THREADED STEM FITTINGS

TS02



# STAINLESS STEEL (SS)

## TOP PLATE MODELS

FREE SWIVEL • TOTAL LOCK • DIRECTION LOCK  
1-1/4 TREAD WIDTH



- APPLICATIONS**
- Food Service
  - Case Carts
  - Utility Carts
  - Medical Equipment
  - Institutional Equipment
  - Laboratory Equipment
  - Animal Cages
  - Pharmaceutical Equipment

- FEATURES**
- 304 Stainless Steel, Polished
  - Dual Ball Swivel Raceways for added strength
  - **Total Lock Brake** models lock both swivel and wheel
  - Directional lock models lock swivel only (helps with Steering)
  - Precision ball bearings in wheels for easier rollability
  - Wheels have full plastic thread guards for added protection
  - TPP and AMP wheels are crowned for easy rolling and turning

Our SS series design is constructed of stainless steel. This design gives you the quality necessary for most medical and pharmaceutical applications at an affordable price.

## SWIVEL TOP PLATE MODELS

Wheel Diameter (Inches)	Tread Width (Inches)	Wheel Description	Capacity (Lbs)	Load Height Inches (mm)	Swivel Radius Inches (mm)	Wheel Bearing	Model Number
3	1-1/4	Conductive Rubber	165	4-7/16" (113)	2-29/32" (74)	Annular Ball	SS-03CRB-125-SW-TP01
3	1-1/4	Thermoplastic Rubber	165	4-7/16" (113)	2-29/32" (74)	Precision Ball	SS-03TPP-125-SW-TP01
3	1-1/4	Anti-Microbial TPR	165	4-7/16" (113)	2-29/32" (74)	Precision Ball	SS-03AMP-125-SW-TP01
3	1-1/4	Polyurethane TPU	165	4-7/16" (113)	2-29/32" (74)	Precision Ball	SS-03PYP-125-SW-TP01
4	1-1/4	Conductive Rubber	190	5-7/16" (138)	3-37/64" (91)	Annular Ball	SS-04CRB-125-SW-TP01
4	1-1/4	Thermoplastic Rubber	190	5-7/16" (138)	3-37/64" (91)	Precision Ball	SS-04TPP-125-SW-TP01
4	1-1/4	Anti-Microbial TPR	190	5-7/16" (138)	3-37/64" (91)	Precision Ball	SS-04AMP-125-SW-TP01
4	1-1/4	Polyurethane TPU	190	5-7/16" (138)	3-37/64" (91)	Precision Ball	SS-04PYP-125-SW-TP01
5	1-1/4	Conductive Rubber	220	6-7/16" (163)	4-7/32" (108)	Annular Ball	SS-05CRB-125-SW-TP01
5	1-1/4	Thermoplastic Rubber	220	6-7/16" (163)	4-7/32" (108)	Precision Ball	SS-05TPP-125-SW-TP01
5	1-1/4	Anti-Microbial TPR	220	6-7/16" (163)	4-7/32" (108)	Precision Ball	SS-05AMP-125-SW-TP01
5	1-1/4	Polyurethane TPU	220	6-7/16" (163)	4-7/32" (108)	Precision Ball	SS-05PYP-125-SW-TP01
6	1-1/4	Conductive Rubber	240	7-13/32" (188)	4-39/64 (117)	Annular Ball	SS-06CRB-125-SW-TP01
6	1-1/4	Thermoplastic Rubber	240	7-13/32" (188)	4-39/64 (117)	Precision Ball	SS-06TPP-125-SW-TP01
6	1-1/4	Anti-Microbial TPR	240	7-13/32" (188)	4-39/64 (117)	Precision Ball	SS-06AMP-125-SW-TP01
6	1-1/4	Polyurethane TPU	240	7-13/32" (188)	4-39/64 (117)	Precision Ball	SS-06PYP-125-SW-TP01



Rigid models available change "SW to "RG"

## TOP PLATE FITTING

Swivel Top Plate Pattern

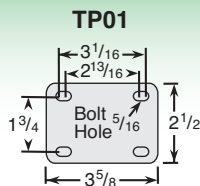

Anti-Microbial wheels have light green tread.



### Other Wheel Bearing Options

**Stainless steel:** Change bearing code to "X"  
(Example : SS-03PYX-125-SW-TP01)

**NEW Delrin:** Change bearing code to "N"  
(Example : SS-03TPN-125-SW-TP01)

# STAINLESS STEEL (SS)

## SWIVEL TOP PLATE TOTAL LOCK MODELS (LOCKS WHEEL AND SWIVEL)

Wheel Diameter (Inches)	Tread Width (Inches)	Wheel Description	Capacity (Lbs)	Load Height Inches (mm)	Swivel Radius Inches (mm)	Wheel Bearing	Model Number
3	1-1/4	Conductive Rubber	165	4-7/16" (113)	4-1/4" (108)	Annular Ball	SS-03CRB-125-TL-TP01
3	1-1/4	Thermoplastic Rubber	165	4-7/16" (113)	4-1/4" (108)	Precision Ball	SS-03TPP-125-TL-TP01
3	1-1/4	Anti-Microbial TPR	165	4-7/16" (113)	4-1/4" (108)	Precision Ball	SS-03AMP-125-TL-TP01
3	1-1/4	Polyurethane TPU	165	4-7/16" (113)	4-1/4" (108)	Precision Ball	SS-03PYP-125-TL-TP01
4	1-1/4	Conductive Rubber	190	5-7/16" (138)	4-35/64" (115)	Annular Ball	SS-04CRB-125-TL-TP01
4	1-1/4	Thermoplastic Rubber	190	5-7/16" (138)	4-35/64" (115)	Precision Ball	SS-04TPP-125-TL-TP01
4	1-1/4	Anti-Microbial TPR	190	5-7/16" (138)	4-35/64" (115)	Precision Ball	SS-04AMP-125-TL-TP01
4	1-1/4	Polyurethane TPU	190	5-7/16" (138)	4-35/64" (115)	Precision Ball	SS-04PYP-125-TL-TP01
5	1-1/4	Conductive Rubber	220	6-7/16" (163)	4-55/64" (123)	Annular Ball	SS-05CRB-125-TL-TP01
5	1-1/4	Thermoplastic Rubber	220	6-7/16" (163)	4-55/64" (123)	Precision Ball	SS-05TPP-125-TL-TP01
5	1-1/4	Anti-Microbial TPR	220	6-7/16" (163)	4-55/64" (123)	Precision Ball	SS-05AMP-125-TL-TP01
5	1-1/4	Polyurethane TPU	220	6-7/16" (163)	4-55/64" (123)	Precision Ball	SS-05PYP-125-TL-TP01
6	1-1/4	Conductive Rubber	240	7-13/32" (188)	4-55/64" (123)	Annular Ball	SS-06CRB-125-TL-TP01
6	1-1/4	Thermoplastic Rubber	240	7-13/32" (188)	4-55/64" (123)	Precision Ball	SS-06TPP-125-TL-TP01
6	1-1/4	Anti-Microbial TPR	240	7-13/32" (188)	4-55/64" (123)	Precision Ball	SS-06AMP-125-TL-TP01
6	1-1/4	Polyurethane TPU	240	7-13/32" (188)	4-55/64" (123)	Precision Ball	SS-06PYP-125-TL-TP01



**Total Lock**  
Change "SW" to "TL". **Red** sticker on pedal.

## SWIVEL TOP PLATE DIRECTION LOCK MODELS (LOCKS SWIVEL ONLY)

Wheel Diameter (Inches)	Tread Width (Inches)	Wheel Description	Capacity (Lbs)	Load Height Inches (mm)	Swivel Radius Inches (mm)	Wheel Bearing	Model Number
3	1-1/4	Conductive Rubber	165	4-7/16" (113)	4-1/4" (108)	Annular Ball	SS-03CRB-125-DL-TP01
3	1-1/4	Thermoplastic Rubber	165	4-7/16" (113)	4-1/4" (108)	Precision Ball	SS-03TPP-125-DL-TP01
3	1-1/4	Anti-Microbial TPR	165	4-7/16" (113)	4-1/4" (108)	Precision Ball	SS-03AMP-125-DL-TP01
3	1-1/4	Polyurethane TPU	165	4-7/16" (113)	4-1/4" (108)	Precision Ball	SS-03PYP-125-DL-TP01
4	1-1/4	Conductive Rubber	190	5-7/16" (138)	4-35/64" (115)	Annular Ball	SS-04CRB-125-DL-TP01
4	1-1/4	Thermoplastic Rubber	190	5-7/16" (138)	4-35/64" (115)	Precision Ball	SS-04TPP-125-DL-TP01
4	1-1/4	Anti-Microbial TPR	190	5-7/16" (138)	4-35/64" (115)	Precision Ball	SS-04AMP-125-DL-TP01
4	1-1/4	Polyurethane TPU	190	5-7/16" (138)	4-35/64" (115)	Precision Ball	SS-04PYP-125-DL-TP01
5	1-1/4	Conductive Rubber	220	6-7/16" (163)	4-55/64" (123)	Annular Ball	SS-05CRB-125-DL-TP01
5	1-1/4	Thermoplastic Rubber	220	6-7/16" (163)	4-55/64" (123)	Precision Ball	SS-05TPP-125-DL-TP01
5	1-1/4	Anti-Microbial TPR	220	6-7/16" (163)	4-55/64" (123)	Precision Ball	SS-05AMP-125-DL-TP01
5	1-1/4	Polyurethane TPU	220	6-7/16" (163)	4-55/64" (123)	Precision Ball	SS-05PYP-125-DL-TP01
6	1-1/4	Conductive Rubber	240	7-13/32" (188)	4-55/64" (123)	Annular Ball	SS-06CRB-125-DL-TP01
6	1-1/4	Thermoplastic Rubber	240	7-13/32" (188)	4-55/64" (123)	Precision Ball	SS-06TPP-125-DL-TP01
6	1-1/4	Anti-Microbial TPR	240	7-13/32" (188)	4-55/64" (123)	Precision Ball	SS-06AMP-125-DL-TP01
6	1-1/4	Polyurethane TPU	240	7-13/32" (188)	4-55/64" (123)	Precision Ball	SS-06PYP-125-DL-TP01



**Direction Lock**  
Change "SW" to "DL". **Green** sticker on pedal.

### TOP PLATE FITTING

Swivel Top Plate Pattern

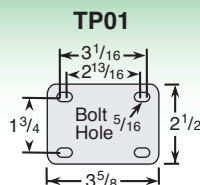

#### Other Wheel Bearing Options

**Stainless steel:** Change bearing code to "X"  
(Example : SS-03PYX-125-SW-TP01)

**NEW Delrin:** Change bearing code to "N"  
(Example : SS-03TPN-125-SW-TP01)

# STAINLESS STEEL (SS)

**HOLLOW KINGPIN MODELS**  
 FREE SWIVEL • TOTAL LOCK • DIRECTION LOCK  
 1-1/4 TREAD WIDTH



- APPLICATIONS**
- Food Service
  - Case Carts
  - Utility Carts
  - Medical Equipment
  - Institutional Equipment
  - Laboratory Equipment
  - Animal Cages
  - Pharmaceutical Equipment

- FEATURES**
- 304 Stainless Steel, Polished
  - Dual Ball Swivel Raceways for added strength
  - **Total Lock Brake** models lock both swivel and wheel
  - Directional lock models lock swivel only (helps with Steering)
  - Precision ball bearings in wheels for easier rollability
  - Wheels have full plastic thread guards for added protection
  - TPP and AMP wheels are crowned for easy rolling and turning

Our SS series design is constructed of stainless steel. This design gives you the quality necessary for most medical and pharmaceutical applications at an affordable price.

## HOLLOW KINGPIN MODELS

Wheel Diameter (Inches)	Tread Width (Inches)	Wheel Description	Capacity (Lbs)	Load Height Inches (mm)	Swivel Radius Inches (mm)	Wheel Bearing	Model Number
3	1-1/4	Conductive Rubber	165	4-5/16" (109)	2-29/32" (74)	Annular Ball	SS-03CRB-125-SW-HKU1
3	1-1/4	Thermoplastic Rubber	165	4-5/16" (109)	2-29/32" (74)	Precision Ball	SS-03TPP-125-SW-HKU1
3	1-1/4	Anti-Microbial TPR	165	4-5/16" (109)	2-29/32" (74)	Precision Ball	SS-03AMP-125-SW-HKU1
3	1-1/4	Polyurethane TPU	165	4-5/16" (109)	2-29/32" (74)	Precision Ball	SS-03PYP-125-SW-HKU1
4	1-1/4	Conductive Rubber	190	5-5/16" (135)	3-37/64" (91)	Annular Ball	SS-04CRB-125-SW-HKU1
4	1-1/4	Thermoplastic Rubber	190	5-5/16" (135)	3-37/64" (91)	Precision Ball	SS-04TPP-125-SW-HKU1
4	1-1/4	Anti-Microbial TPR	190	5-5/16" (135)	3-37/64" (91)	Precision Ball	SS-04AMP-125-SW-HKU1
4	1-1/4	Polyurethane TPU	190	5-5/16" (135)	3-37/64" (91)	Precision Ball	SS-04PYP-125-SW-HKU1
5	1-1/4	Conductive Rubber	220	6-5/16" (160)	4-7/32" (108)	Annular Ball	SS-05CRB-125-SW-HKU1
5	1-1/4	Thermoplastic Rubber	220	6-5/16" (160)	4-7/32" (108)	Precision Ball	SS-05TPP-125-SW-HKU1
5	1-1/4	Anti-Microbial TPR	220	6-5/16" (160)	4-7/32" (108)	Precision Ball	SS-05AMP-125-SW-HKU1
5	1-1/4	Polyurethane TPU	220	6-5/16" (160)	4-7/32" (108)	Precision Ball	SS-05PYP-125-SW-HKU1
6	1-1/4	Conductive Rubber	240	7-9/32" (185)	4-39/64 (117)	Annular Ball	SS-06CRB-125-SW-HKU1
6	1-1/4	Thermoplastic Rubber	240	7-9/32" (185)	4-39/64 (117)	Precision Ball	SS-06TPP-125-SW-HKU1
6	1-1/4	Anti-Microbial TPR	240	7-9/32" (185)	4-39/64 (117)	Precision Ball	SS-06AMP-125-SW-HKU1
6	1-1/4	Polyurethane TPU	240	7-9/32" (185)	4-39/64 (117)	Precision Ball	SS-06PYP-125-SW-HKU1



*Anti-Microbial wheels have light green tread.*



## HOLLOW KINGPIN

Caster is **provided unassembled** to make it easy to add your choice of fitting. If you would like these assembled change **HKU1** to **HK01**. 1/2 I.D.



**Other Wheel Bearing Options**  
**Stainless steel:** Change bearing code to "X"  
 (Example : SS-03PYX-125-SW-HKU1)  
**NEW Delrin:** Change bearing code to "N"  
 (Example : SS-03TPN-125-SW-HKU1)



# STAINLESS STEEL (SS)

## HOLLOW KINGPIN TOTAL LOCK MODELS (LOCKS WHEEL AND SWIVEL)

Wheel Diameter (Inches)	Tread Width (Inches)	Wheel Description	Capacity (Lbs)	Load Height Inches (mm)	Swivel Radius Inches (mm)	Wheel Bearing	Model Number
3	1-1/4	Conductive Rubber	165	4-5/16" (109)	4-1/4" (108)	Annular Ball	SS-03CRB-125-TL-HKU1
3	1-1/4	Thermoplastic Rubber	165	4-5/16" (109)	4-1/4" (108)	Precision Ball	SS-03TPP-125-TL-HKU1
3	1-1/4	Anti-Microbial TPR	165	4-5/16" (109)	4-1/4" (108)	Precision Ball	SS-03AMP-125-TL-HKU1
3	1-1/4	Polyurethane TPU	165	4-5/16" (109)	4-1/4" (108)	Precision Ball	SS-03PYP-125-TL-HKU1
4	1-1/4	Conductive Rubber	190	5-5/16" (135)	4-35/64" (115)	Annular Ball	SS-04CRB-125-TL-HKU1
4	1-1/4	Thermoplastic Rubber	190	5-5/16" (135)	4-35/64" (115)	Precision Ball	SS-04TPP-125-TL-HKU1
4	1-1/4	Anti-Microbial TPR	190	5-5/16" (135)	4-35/64" (115)	Precision Ball	SS-04AMP-125-TL-HKU1
4	1-1/4	Polyurethane TPU	190	5-5/16" (135)	4-35/64" (115)	Precision Ball	SS-04PYP-125-TL-HKU1
5	1-1/4	Conductive Rubber	220	6-5/16" (160)	4-55/64" (123)	Annular Ball	SS-05CRB-125-TL-HKU1
5	1-1/4	Thermoplastic Rubber	220	6-5/16" (160)	4-55/64" (123)	Precision Ball	SS-05TPP-125-TL-HKU1
5	1-1/4	Anti-Microbial TPR	220	6-5/16" (160)	4-55/64" (123)	Precision Ball	SS-05AMP-125-TL-HKU1
5	1-1/4	Polyurethane TPU	220	6-5/16" (160)	4-55/64" (123)	Precision Ball	SS-05PYP-125-TL-HKU1
6	1-1/4	Conductive Rubber	240	7-9/32" (185)	4-55/64" (123)	Annular Ball	SS-06CRB-125-TL-HKU1
6	1-1/4	Thermoplastic Rubber	240	7-9/32" (185)	4-55/64" (123)	Precision Ball	SS-06TPP-125-TL-HKU1
6	1-1/4	Anti-Microbial TPR	240	7-9/32" (185)	4-55/64" (123)	Precision Ball	SS-06AMP-125-TL-HKU1
6	1-1/4	Polyurethane TPU	240	7-9/32" (185)	4-55/64" (123)	Precision Ball	SS-06PYP-125-TL-HKU1



**Total Lock**  
Change "SW"  
to "TL". **Red**  
sticker on pedal.

## HOLLOW KINGPIN DIRECTION LOCK MODELS (LOCKS SWIVEL ONLY)

Wheel Diameter (Inches)	Tread Width (Inches)	Wheel Description	Capacity (Lbs)	Load Height Inches (mm)	Swivel Radius Inches (mm)	Wheel Bearing	Model Number
3	1-1/4	Conductive Rubber	165	4-5/16" (109)	4-1/4" (108)	Annular Ball	SS-03CRB-125-DL-HKU1
3	1-1/4	Thermoplastic Rubber	165	4-5/16" (109)	4-1/4" (108)	Precision Ball	SS-03TPP-125-DL-HKU1
3	1-1/4	Anti-Microbial TPR	165	4-5/16" (109)	4-1/4" (108)	Precision Ball	SS-03AMP-125-DL-HKU1
3	1-1/4	Polyurethane TPU	165	4-5/16" (109)	4-1/4" (108)	Precision Ball	SS-03PYP-125-DL-HKU1
4	1-1/4	Conductive Rubber	190	5-5/16" (135)	4-35/64" (115)	Annular Ball	SS-04CRB-125-DL-HKU1
4	1-1/4	Thermoplastic Rubber	190	5-5/16" (135)	4-35/64" (115)	Precision Ball	SS-04TPP-125-DL-HKU1
4	1-1/4	Anti-Microbial TPR	190	5-5/16" (135)	4-35/64" (115)	Precision Ball	SS-04AMP-125-DL-HKU1
4	1-1/4	Polyurethane TPU	190	5-5/16" (135)	4-35/64" (115)	Precision Ball	SS-04PYP-125-DL-HKU1
5	1-1/4	Conductive Rubber	220	6-5/16" (160)	4-55/64" (123)	Annular Ball	SS-05CRB-125-DL-HKU1
5	1-1/4	Thermoplastic Rubber	220	6-5/16" (160)	4-55/64" (123)	Precision Ball	SS-05TPP-125-DL-HKU1
5	1-1/4	Anti-Microbial TPR	220	6-5/16" (160)	4-55/64" (123)	Precision Ball	SS-05AMP-125-DL-HKU1
5	1-1/4	Polyurethane TPU	220	6-5/16" (160)	4-55/64" (123)	Precision Ball	SS-05PYP-125-DL-HKU1
6	1-1/4	Conductive Rubber	240	7-9/32" (185)	4-55/64" (123)	Annular Ball	SS-06CRB-125-DL-HKU1
6	1-1/4	Thermoplastic Rubber	240	7-9/32" (185)	4-55/64" (123)	Precision Ball	SS-06TPP-125-DL-HKU1
6	1-1/4	Anti-Microbial TPR	240	7-9/32" (185)	4-55/64" (123)	Precision Ball	SS-06AMP-125-DL-HKU1
6	1-1/4	Polyurethane TPU	240	7-9/32" (185)	4-55/64" (123)	Precision Ball	SS-06PYP-125-DL-HKU1



**Direction Lock**  
Change "SW"  
to "DL". **Green**  
sticker on pedal.

## HOLLOW KINGPIN

Caster is **provided unassembled** to make it easy to add your choice of fitting. If you would like these assembled change **HKU1** to **HK01**. 1/2 I.D.



### Other Wheel Bearing Options

**Stainless steel:** Change bearing code to "X"  
(Example : SS-03PYX-125-SW-HKU1)

**NEW Delrin:** Change bearing code to "N"  
(Example : SS-03TPN-125-SW-HKU1)

# STAINLESS STEEL (SS)

## STEM MODELS

FREE SWIVEL • TOTAL LOCK • DIRECTION LOCK  
1-1/4 TREAD WIDTH



- APPLICATIONS**
- Food Service
  - Case Carts
  - Utility Carts
  - Medical Equipment
  - Institutional Equipment
  - Laboratory Equipment
  - Animal Cages
  - Pharmaceutical Equipment

- FEATURES**
- 304 Stainless Steel, Polished
  - Dual Ball Swivel Raceways for added strength
  - **Total Lock Brake** models lock both swivel and wheel
  - Directional lock models lock swivel only (helps with Steering)
  - Precision ball bearings in wheels for easier rollability
  - Wheels have full plastic thread guards for added protection
  - TPP and AMP wheels are crowned for easy rolling and turning

Our SS series design is constructed of stainless steel. This design gives you the quality necessary for most medical and pharmaceutical applications at an affordable price.

## STEM MODELS

Wheel Diameter (Inches)	Tread Width (Inches)	Wheel Description	Capacity (lbs)	Load Height Inches (mm)	Swivel Radius Inches (mm)	Wheel Bearing	Model Number
3	1-1/4	Conductive Rubber	165	4-5/16" (109)	2-29/32" (74)	Annular Ball	SS-03CRB-125-SW-____
3	1-1/4	Thermoplastic Rubber	165	4-5/16" (109)	2-29/32" (74)	Precision Ball	SS-03TPP-125-SW-____
3	1-1/4	Anti-Microbial TPR	165	4-5/16" (109)	2-29/32" (74)	Precision Ball	SS-03AMP-125-SW-____
3	1-1/4	Polyurethane TPU	165	4-5/16" (109)	2-29/32" (74)	Precision Ball	SS-03PYP-125-SW-____
4	1-1/4	Conductive Rubber	190	5-5/16" (135)	3-37/64" (91)	Annular Ball	SS-04CRB-125-SW-____
4	1-1/4	Thermoplastic Rubber	190	5-5/16" (135)	3-37/64" (91)	Precision Ball	SS-04TPP-125-SW-____
4	1-1/4	Anti-Microbial TPR	190	5-5/16" (135)	3-37/64" (91)	Precision Ball	SS-04AMP-125-SW-____
4	1-1/4	Polyurethane TPU	190	5-5/16" (135)	3-37/64" (91)	Precision Ball	SS-04PYP-125-SW-____
5	1-1/4	Conductive Rubber	220	6-5/16" (160)	4-7/32" (108)	Annular Ball	SS-05CRB-125-SW-____
5	1-1/4	Thermoplastic Rubber	220	6-5/16" (160)	4-7/32" (108)	Precision Ball	SS-05TPP-125-SW-____
5	1-1/4	Anti-Microbial TPR	220	6-5/16" (160)	4-7/32" (108)	Precision Ball	SS-05AMP-125-SW-____
5	1-1/4	Polyurethane TPU	220	6-5/16" (160)	4-7/32" (108)	Precision Ball	SS-05PYP-125-SW-____
6	1-1/4	Conductive Rubber	240	7-9/32" (185)	4-39/64 (117)	Annular Ball	SS-06CRB-125-SW-____
6	1-1/4	Thermoplastic Rubber	240	7-9/32" (185)	4-39/64 (117)	Precision Ball	SS-06TPP-125-SW-____
6	1-1/4	Anti-Microbial TPR	240	7-9/32" (185)	4-39/64 (117)	Precision Ball	SS-06AMP-125-SW-____
6	1-1/4	Polyurethane TPU	240	7-9/32" (185)	4-39/64 (117)	Precision Ball	SS-06PYP-125-SW-____



Anti-Microbial wheels have light green tread.



## STEM FITTINGS

See fittings page for more options.

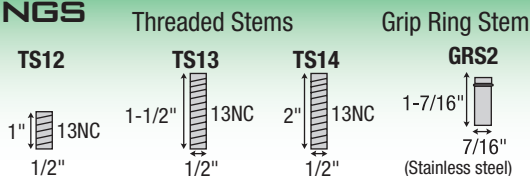

Round and square stems available, please consult factory.

### Other Wheel Bearing Options

**Stainless steel:** Change bearing code to "X"  
(Example : SS-03PYX-125-SW-TS12)

**NEW Delrin:** Change bearing code to "N"  
(Example : SS-03TPN-125-SW-TS12)

# STAINLESS STEEL (SS)

## STEM TOTAL LOCK MODELS (LOCKS WHEEL AND SWIVEL)

Wheel Diameter (Inches)	Tread Width (Inches)	Wheel Description	Capacity (Lbs)	Load Height Inches (mm)	Swivel Radius Inches (mm)	Wheel Bearing	Model Number
3	1-1/4	Conductive Rubber	165	4-5/16" (109)	4-1/4" (108)	Annular Ball	SS-03CRB-125-TL-____
3	1-1/4	Thermoplastic Rubber	165	4-5/16" (109)	4-1/4" (108)	Precision Ball	SS-03TPP-125-TL-____
3	1-1/4	Anti-Microbial TPR	165	4-5/16" (109)	4-1/4" (108)	Precision Ball	SS-03AMP-125-TL-____
3	1-1/4	Polyurethane TPU	165	4-5/16" (109)	4-1/4" (108)	Precision Ball	SS-03PYP-125-TL-____
4	1-1/4	Conductive Rubber	190	5-5/16" (135)	4-35/64" (115)	Annular Ball	SS-04CRB-125-TL-____
4	1-1/4	Thermoplastic Rubber	190	5-5/16" (135)	4-35/64" (115)	Precision Ball	SS-04TPP-125-TL-____
4	1-1/4	Anti-Microbial TPR	190	5-5/16" (135)	4-35/64" (115)	Precision Ball	SS-04AMP-125-TL-____
4	1-1/4	Polyurethane TPU	190	5-5/16" (135)	4-35/64" (115)	Precision Ball	SS-04PYP-125-TL-____
5	1-1/4	Conductive Rubber	220	6-5/16" (160)	4-55/64" (123)	Annular Ball	SS-05CRB-125-TL-____
5	1-1/4	Thermoplastic Rubber	220	6-5/16" (160)	4-55/64" (123)	Precision Ball	SS-05TPP-125-TL-____
5	1-1/4	Anti-Microbial TPR	220	6-5/16" (160)	4-55/64" (123)	Precision Ball	SS-05AMP-125-TL-____
5	1-1/4	Polyurethane TPU	220	6-5/16" (160)	4-55/64" (123)	Precision Ball	SS-05PYP-125-TL-____
6	1-1/4	Conductive Rubber	240	7-9/32" (185)	4-55/64" (123)	Annular Ball	SS-06CRB-125-TL-____
6	1-1/4	Thermoplastic Rubber	240	7-9/32" (185)	4-55/64" (123)	Precision Ball	SS-06TPP-125-TL-____
6	1-1/4	Anti-Microbial TPR	240	7-9/32" (185)	4-55/64" (123)	Precision Ball	SS-06AMP-125-TL-____
6	1-1/4	Polyurethane TPU	240	7-9/32" (185)	4-55/64" (123)	Precision Ball	SS-06PYP-125-TL-____



**Total Lock**  
Change "SW" to "TL". **Red** sticker on pedal.

## STEM DIRECTION LOCK MODELS (LOCKS SWIVEL ONLY)

Wheel Diameter (Inches)	Tread Width (Inches)	Wheel Description	Capacity (Lbs)	Load Height Inches (mm)	Swivel Radius Inches (mm)	Wheel Bearing	Model Number
3	1-1/4	Conductive Rubber	165	4-5/16" (109)	4-1/4" (108)	Annular Ball	SS-03CRB-125-DL-____
3	1-1/4	Thermoplastic Rubber	165	4-5/16" (109)	4-1/4" (108)	Precision Ball	SS-03TPP-125-DL-____
3	1-1/4	Anti-Microbial TPR	165	4-5/16" (109)	4-1/4" (108)	Precision Ball	SS-03AMP-125-DL-____
3	1-1/4	Polyurethane TPU	165	4-5/16" (109)	4-1/4" (108)	Precision Ball	SS-03PYP-125-DL-____
4	1-1/4	Conductive Rubber	190	5-5/16" (135)	4-35/64" (115)	Annular Ball	SS-04CRB-125-DL-____
4	1-1/4	Thermoplastic Rubber	190	5-5/16" (135)	4-35/64" (115)	Precision Ball	SS-04TPP-125-DL-____
4	1-1/4	Anti-Microbial TPR	190	5-5/16" (135)	4-35/64" (115)	Precision Ball	SS-04AMP-125-DL-____
4	1-1/4	Polyurethane TPU	190	5-5/16" (135)	4-35/64" (115)	Precision Ball	SS-04PYP-125-DL-____
5	1-1/4	Conductive Rubber	220	6-5/16" (160)	4-55/64" (123)	Annular Ball	SS-05CRB-125-DL-____
5	1-1/4	Thermoplastic Rubber	220	6-5/16" (160)	4-55/64" (123)	Precision Ball	SS-05TPP-125-DL-____
5	1-1/4	Anti-Microbial TPR	220	6-5/16" (160)	4-55/64" (123)	Precision Ball	SS-05AMP-125-DL-____
5	1-1/4	Polyurethane TPU	220	6-5/16" (160)	4-55/64" (123)	Precision Ball	SS-05PYP-125-DL-____
6	1-1/4	Conductive Rubber	240	7-9/32" (185)	4-55/64" (123)	Annular Ball	SS-06CRB-125-DL-____
6	1-1/4	Thermoplastic Rubber	240	7-9/32" (185)	4-55/64" (123)	Precision Ball	SS-06TPP-125-DL-____
6	1-1/4	Anti-Microbial TPR	240	7-9/32" (185)	4-55/64" (123)	Precision Ball	SS-06AMP-125-DL-____
6	1-1/4	Polyurethane TPU	240	7-9/32" (185)	4-55/64" (123)	Precision Ball	SS-06PYP-125-DL-____



**Direction Lock**  
Change "SW" to "DL". **Green** sticker on pedal.

Stems ship with a loose bolt for easier alignment of the directional lock. The direction lock caster will not remain in a fixed position when used with a grip ring stem.

Specify code, see fittings at left for dimensions.

### STEM FITTINGS

See fittings page for more options.

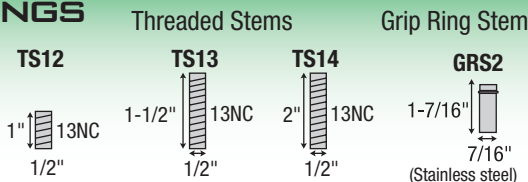

Round and square stems available, please consult factory.

### Other Wheel Bearing Options

**Stainless steel:** Change bearing code to "X"  
(Example : SS-03PYX-125-SW-TS12)

**NEW Delrin:** Change bearing code to "N"  
(Example : SS-03TPN-125-SW-TS12)

# STAINLESS STEEL (SS)

**TOP PLATE MODELS**  
 FREE SWIVEL • TOTAL LOCK  
 2" TREAD WIDTH



New Total Lock brake design – locks both brake and swivel.

Eagle Polyurethane wheels now available



- APPLICATIONS**
- Food Service
  - Case Carts
  - Utility Carts
  - Medical Equipment
  - Institutional Equipment
  - Laboratory Equipment
  - Animal Cages
  - Pharmaceutical Equipment

- FEATURES**
- Fork legs, top plate and yoke base are made of 1/4" thick 304 polished stainless steel for added corrosion protection
  - **Total Lock brake** models lock both brake and swivel
  - Dual Ball Swivel Raceways for added strength
  - Swivel seals are standard for added protection
  - Stainless axles provided with grease fitting
  - Grease fitting in swivel raceway

Our SS series design is constructed of stainless steel. This design gives you the quality necessary for most medical and pharmaceutical applications at an affordable price.

Stainless Steel  
 Top Lock Brake  
 (Change SW to TB)

Example :  
 SS-06PSR-200-TB-TP03



## TOP PLATE FITTING

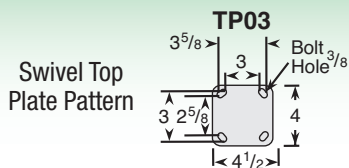

## STAINLESS STEEL TOP LOCK BRAKE

Wheel Diameter	Kit Number
4"	SS04200
5"	SS05200
6"	SS06200
8"	SS08200



To order field installable kit specify kit number. To order on caster change fork code from "SW" to "TB"

(Example: SS-06PSR-200-TB-TP03)

# STAINLESS STEEL (SS)

## TOP PLATE MODELS

Wheel Diameter (Inches)	Tread Width (Inches)	Wheel Description	Capacity (Lbs)	Load Height (Inches)	Swivel Radius (Inches)	Wheel Bearing	Model Number
4	2	White Polyolefin	550	5-5/8	3-3/8	Delrin	SS-04PWD-200-SW-TP03
4	2	White Polyolefin	550	5-5/8	3-3/8	Roller	SS-04PWR-200-SW-TP03
4	2	Polyurethane Eagle	600	5-5/8	3-3/8	Delrin	SS-04EPD-200-SW-TP03
4	2	Polyurethane Eagle	600	5-5/8	3-3/8	Roller	SS-04EPR-200-SW-TP03
4	2	Polyurethane Solid	800	5-5/8	3-3/8	Roller	SS-04PSR-200-SW-TP03
4	2	Polyurethane Solid	800	5-5/8	3-3/8	Delrin	SS-04PSD-200-SW-TP03
5	2	White Polyolefin	650	6-1/2	4-1/8	Delrin	SS-05PWD-200-SW-TP03
5	2	White Polyolefin	650	6-1/2	4-1/8	Roller	SS-05PWR-200-SW-TP03
5	2	Polyurethane Eagle	900	6-1/2	4-1/8	Delrin	SS-05EPD-200-SW-TP03
5	2	Polyurethane Eagle	900	6-1/2	4-1/8	Roller	SS-05EPR-200-SW-TP03
5	2	Polyurethane Solid	900	6-1/2	4-1/8	Roller	SS-05PSR-200-SW-TP03
5	2	Polyurethane Solid	900	6-1/2	4-1/8	Delrin	SS-05PSD-200-SW-TP03
6	2	White Polyolefin	700	7-1/2	4-3/4	Delrin	SS-06PWD-200-SW-TP03
6	2	White Polyolefin	700	7-1/2	4-3/4	Roller	SS-06PWR-200-SW-TP03
6	2	Polyurethane Solid	900	7-1/2	4-3/4	Roller	SS-06PSR-200-SW-TP03
6	2	Polyurethane Solid	900	7-1/2	4-3/4	Delrin	SS-06PSD-200-SW-TP03
6	2	Polyurethane Eagle	1000	7-1/2	4-3/4	Delrin	SS-06EPD-200-SW-TP03
6	2	Polyurethane Eagle	1000	7-1/2	4-3/4	Roller	SS-06EPR-200-SW-TP03
8	2	White Polyolefin	800	9-1/2	5-3/4	Delrin	SS-08PWD-200-SW-TP03
8	2	White Polyolefin	800	9-1/2	5-3/4	Roller	SS-08PWR-200-SW-TP03
8	2	Polyurethane Solid	900	9-1/2	5-3/4	Roller	SS-08PSR-200-SW-TP03
8	2	Polyurethane Solid	900	9-1/2	5-3/4	Delrin	SS-08PSD-200-SW-TP03
8	2	Polyurethane Eagle	1000	9-1/2	5-3/4	Delrin	SS-08EPD-200-SW-TP03
8	2	Polyurethane Eagle	1000	9-1/2	5-3/4	Roller	SS-08EPR-200-SW-TP03



Stainless Steel Roller Bearings available, change bearing designation to S, example SS-08PWS200-SW-TP03.

Stainless Steel Precision Bearings available on some models, please consult factory.

Other bearings also available, please consult factory.

Stainless wheel brakes are available for swivel models, Change SW to TB.

Rigid models are available, change SW to RG.

Stainless Steel **Total Lock** brake available for swivel models, change SW to TL.

## TOP PLATE FITTING

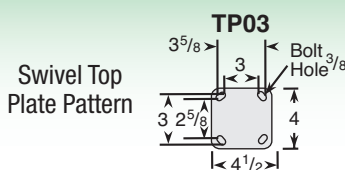

## Total Lock Swivel Lead/Swivel Radius

Part Number	Swivel Lead	Swivel Radius
SS04200TL-TP03	34.0 mm	150.6 mm
SS05200TL-TP03	38.2 mm	160.5 mm
SS06200TL-TP03	44.3 mm	170.8 mm
SS08200TL-TP03	56.0 mm	193.5 mm



# STAINLESS HOSPITAL (SX)

## TOP PLATE MODELS

FREE SWIVEL • TOTAL LOCK • DIRECTION LOCK

**NEW**



Thermoplastic rubber with  
Stainless plated thread guard  
SX-05TPX-125-SW-TP13-CTG

Anti-microbial TPR wheel  
with total lock brake  
SX-05AMX-125-TL-TP13

### APPLICATIONS

- Food Service
- Case Carts
- Utility Carts
- Hospital Equipment
- Institutional Equipment
- Store Fixtures
- Medical equipment

### FEATURES

- Polished 304 stainless steel
- **NEW** double pedal brake design for easy on/off function for both total lock and direction lock casters
- Dual ball heat treated raceways for added strength
- **Total Lock Brake** models lock both swivel and wheel
- Directional lock models lock swivel only (helps with steering)
- Stainless steel precision ball bearings in wheels for easier rollability
- Wheels have full thread guards for added protection
- Comes standard with upper raceway seal

The SX series brings you stainless institutional casters at an affordable price.

## SWIVEL TOP PLATE MODELS

Wheel Diameter (Inches)	Tread Width (Inches)	Wheel Description	Capacity (Lbs)	Load Height Inches (mm)	Swivel Radius Inches (mm)	Wheel Bearing	Model Number
3	1-1/4	Thermoplastic Rubber	220	4-7/16" (113)	3-1/4" (83)	Precision Ball	SX-03TPX-125-SW-TP13
3	1-1/4	Anti-Microbial TPR	190	4-7/16" (113)	3-1/4" (83)	Precision Ball	SX-03AMX-125-SW-TP13
3	1-1/4	Polyurethane TPU	220	4-7/16" (113)	3-1/4" (83)	Precision Ball	SX-03PYX-125-SW-TP13
4	1-1/4	Thermoplastic Rubber	240	5-7/16" (138)	3-3/4" (95)	Precision Ball	SX-04TPX-125-SW-TP13
4	1-1/4	Anti-Microbial TPR	240	5-7/16" (138)	3-3/4" (95)	Precision Ball	SX-04AMX-125-SW-TP13
4	1-1/4	Polyurethane TPU	240	5-7/16" (138)	3-3/4" (95)	Precision Ball	SX-04PYX-125-SW-TP13
5	1-1/4	Thermoplastic Rubber	275	6-7/16" (163)	4-1/4" (108)	Precision Ball	SX-05TPX-125-SW-TP13
5	1-1/4	Anti-Microbial TPR	260	6-7/16" (163)	4-1/4" (108)	Precision Ball	SX-05AMX-125-SW-TP13
5	1-1/4	Polyurethane TPU	275	6-7/16" (163)	4-1/4" (108)	Precision Ball	SX-05PYX-125-SW-TP13
6	1-1/4	Thermoplastic Rubber	300	7-7/16" (188)	4-5/8 (117)	Precision Ball	SX-06TPX-125-SW-TP13
6	1-1/4	Anti-Microbial TPR	260	7-7/16" (188)	4-5/8 (117)	Precision Ball	SX-06AMX-125-SW-TP13
6	1-1/4	Polyurethane TPU	300	7-7/16" (188)	4-5/8 (117)	Precision Ball	SX-06PYX-125-SW-TP13



## TOP PLATE FITTING

TP13 is standard plate. Other plate sizes available with minimum order quantities. Consult MedCaster.

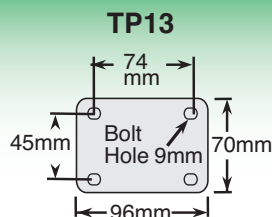

**NEW** Delrin: Change bearing code to "N"  
(Example : SX-03TPN-125-SW-TP13)

# STAINLESS HOSPITAL (SX)

## SWIVEL TOP PLATE TOTAL LOCK MODELS (LOCKS WHEEL AND SWIVEL)

Wheel Diameter (Inches)	Tread Width (Inches)	Wheel Description	Capacity (Lbs)	Load Height Inches (mm)	Swivel Radius Inches (mm)	Wheel Bearing	Model Number
3	1-1/4	Thermoplastic Rubber	220	4-7/16" (113)	4-1/4" (107)	Precision Ball	SX-03TPX-125-TL-TP13
3	1-1/4	Anti-Microbial TPR	190	4-7/16" (113)	4-1/4" (107)	Precision Ball	SX-03AMX-125-TL-TP13
3	1-1/4	Polyurethane TPU	220	4-7/16" (113)	4-1/4" (107)	Precision Ball	SX-03PYX-125-TL-TP13
4	1-1/4	Thermoplastic Rubber	240	5-7/16" (138)	4-3/16" (106)	Precision Ball	SX-04TPX-125-TL-TP13
4	1-1/4	Anti-Microbial TPR	240	5-7/16" (138)	4-3/16" (106)	Precision Ball	SX-04AMX-125-TL-TP13
4	1-1/4	Polyurethane TPU	240	5-7/16" (138)	4-3/16" (106)	Precision Ball	SX-04PYX-125-TL-TP13
5	1-1/4	Thermoplastic Rubber	275	6-7/16" (163)	4-5/16" (109)	Precision Ball	SX-05TPX-125-TL-TP13
5	1-1/4	Anti-Microbial TPR	260	6-7/16" (163)	4-5/16" (109)	Precision Ball	SX-05AMX-125-TL-TP13
5	1-1/4	Polyurethane TPU	275	6-7/16" (163)	4-5/16" (109)	Precision Ball	SX-05PYX-125-TL-TP13
6	1-1/4	Thermoplastic Rubber	300	7-7/16" (188)	4-3/4" (119)	Precision Ball	SX-06TPX-125-TL-TP13
6	1-1/4	Anti-Microbial TPR	260	7-7/16" (188)	4-3/4" (119)	Precision Ball	SX-06AMX-125-TL-TP13
6	1-1/4	Polyurethane TPU	300	7-7/16" (188)	4-3/4" (119)	Precision Ball	SX-06PYX-125-TL-TP13



**Total Lock**  
Red pedal.

## SWIVEL TOP PLATE DIRECTION LOCK MODELS (LOCKS SWIVEL ONLY)

Wheel Diameter (Inches)	Tread Width (Inches)	Wheel Description	Capacity (Lbs)	Load Height Inches (mm)	Swivel Radius Inches (mm)	Wheel Bearing	Model Number
3	1-1/4	Thermoplastic Rubber	220	4-7/16" (113)	4-1/4" (107)	Precision Ball	SX-03TPX-125-DL-TP13
3	1-1/4	Anti-Microbial TPR	190	4-7/16" (113)	4-1/4" (107)	Precision Ball	SX-03AMX-125-DL-TP13
3	1-1/4	Polyurethane TPU	220	4-7/16" (113)	4-1/4" (107)	Precision Ball	SX-03PYX-125-DL-TP13
4	1-1/4	Thermoplastic Rubber	240	5-7/16" (138)	4-3/16" (106)	Precision Ball	SX-04TPX-125-DL-TP13
4	1-1/4	Anti-Microbial TPR	240	5-7/16" (138)	4-3/16" (106)	Precision Ball	SX-04AMX-125-DL-TP13
4	1-1/4	Polyurethane TPU	240	5-7/16" (138)	4-3/16" (106)	Precision Ball	SX-04PYX-125-DL-TP13
5	1-1/4	Thermoplastic Rubber	275	6-7/16" (163)	4-5/16" (109)	Precision Ball	SX-05TPX-125-DL-TP13
5	1-1/4	Anti-Microbial TPR	260	6-7/16" (163)	4-5/16" (109)	Precision Ball	SX-05AMX-125-DL-TP13
5	1-1/4	Polyurethane TPU	275	6-7/16" (163)	4-5/16" (109)	Precision Ball	SX-05PYX-125-DL-TP13
6	1-1/4	Thermoplastic Rubber	300	7-7/16" (188)	4-3/4" (119)	Precision Ball	SX-06TPX-125-DL-TP13
6	1-1/4	Anti-Microbial TPR	260	7-7/16" (188)	4-3/4" (119)	Precision Ball	SX-06AMX-125-DL-TP13
6	1-1/4	Polyurethane TPU	300	7-7/16" (188)	4-3/4" (119)	Precision Ball	SX-06PYX-125-DL-TP13



**Direction Lock**  
Green pedal.

## TOP PLATE FITTING

TP13 is standard plate. Other plate sizes available with minimum order quantities. Consult MedCaster.

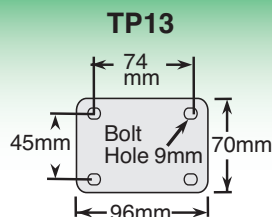

**NEW Delrin:** Change bearing code to "N"  
(Example : SX-03TPN-125-SW-TP13)

# STAINLESS HOSPITAL (SX)

HOLLOW KINGPIN MODELS  
FREE SWIVEL • TOTAL LOCK • DIRECTION LOCK

**NEW**



Thermoplastic rubber wheel  
SX-05TPX-125-SW-HK01



Thermoplastic rubber wheel with  
direction lock  
SX-05TPX-125-DL-HK01

- APPLICATIONS**
- Food Service
  - Case Carts
  - Utility Carts
  - Hospital Equipment
  - Institutional Equipment
  - Store Fixtures
  - Medical equipment

- FEATURES**
- Polished 304 stainless steel
  - **NEW** double pedal brake design for easy on/off function for both total lock and direction lock casters
  - Dual ball heat treated raceways for added strength
  - **Total Lock Brake** models lock both swivel and wheel
  - Directional lock models lock swivel only (helps with steering)
  - Stainless steel precision ball bearings in wheels for easier rollability
  - Wheels have full thread guards for added protection
  - Comes standard with upper raceway seal

The SX series brings you stainless institutional casters at an affordable price.

## HOLLOW KINGPIN MODELS

Wheel Diameter (Inches)	Tread Width (Inches)	Wheel Description	Capacity (Lbs)	Load Height Inches (mm)	Swivel Radius Inches (mm)	Wheel Bearing	Model Number
3	1-1/4	Thermoplastic Rubber	220	4-5/16" (109)	3-1/4" (83)	Precision Ball	SX-03TPX-125-SW-HK01
3	1-1/4	Anti-Microbial TPR	190	4-5/16" (109)	3-1/4" (83)	Precision Ball	SX-03AMX-125-SW-HK01
3	1-1/4	Polyurethane TPU	220	4-5/16" (109)	3-1/4" (83)	Precision Ball	SX-03PYX-125-SW-HK01
4	1-1/4	Thermoplastic Rubber	240	5-5/16" (135)	3-3/4" (95)	Precision Ball	SX-04TPX-125-SW-HK01
4	1-1/4	Anti-Microbial TPR	240	5-5/16" (135)	3-3/4" (95)	Precision Ball	SX-04AMX-125-SW-HK01
4	1-1/4	Polyurethane TPU	240	5-5/16" (135)	3-3/4" (95)	Precision Ball	SX-04PYX-125-SW-HK01
5	1-1/4	Thermoplastic Rubber	275	6-5/16" (160)	4-1/4" (108)	Precision Ball	SX-05TPX-125-SW-HK01
5	1-1/4	Anti-Microbial TPR	260	6-5/16" (160)	4-1/4" (108)	Precision Ball	SX-05AMX-125-SW-HK01
5	1-1/4	Polyurethane TPU	275	6-5/16" (160)	4-1/4" (108)	Precision Ball	SX-05PYX-125-SW-HK01
6	1-1/4	Thermoplastic Rubber	300	7-9/32" (185)	4-5/8" (117)	Precision Ball	SX-06TPX-125-SW-HK01
6	1-1/4	Anti-Microbial TPR	260	7-9/32" (185)	4-5/8" (117)	Precision Ball	SX-06AMX-125-SW-HK01
6	1-1/4	Polyurethane TPU	300	7-9/32" (185)	4-5/8" (117)	Precision Ball	SX-06PYX-125-SW-HK01



## HOLLOW KINGPIN

Caster is **provided assembled**. If you will be using your choice of fitting and would like these casters unassembled, change suffix to **HKU1**. 1/2 I.D.



**NEW** Delrin: Change bearing code to "N"  
(Example : SX-03TPN-125-SW-HK01)



# STAINLESS HOSPITAL (SX)

## HOLLOW KINGPIN TOTAL LOCK MODELS (LOCKS WHEEL AND SWIVEL)

Wheel Diameter (Inches)	Tread Width (Inches)	Wheel Description	Capacity (Lbs)	Load Height Inches (mm)	Swivel Radius Inches (mm)	Wheel Bearing	Model Number
3	1-1/4	Thermoplastic Rubber	220	4-5/16" (109)	4-1/4" (107)	Precision Ball	SX-03TPX-125-TL-HK01
3	1-1/4	Anti-Microbial TPR	190	4-5/16" (109)	4-1/4" (107)	Precision Ball	SX-03AMX-125-TL-HK01
3	1-1/4	Polyurethane TPU	220	4-5/16" (109)	4-1/4" (107)	Precision Ball	SX-03PYX-125-TL-HK01
4	1-1/4	Thermoplastic Rubber	240	5-5/16" (135)	4-3/16" (106)	Precision Ball	SX-04TPX-125-TL-HK01
4	1-1/4	Anti-Microbial TPR	240	5-5/16" (135)	4-3/16" (106)	Precision Ball	SX-04AMX-125-TL-HK01
4	1-1/4	Polyurethane TPU	240	5-5/16" (135)	4-3/16" (106)	Precision Ball	SX-04PYX-125-TL-HK01
5	1-1/4	Thermoplastic Rubber	275	6-5/16" (160)	4-5/16" (109)	Precision Ball	SX-05TPX-125-TL-HK01
5	1-1/4	Anti-Microbial TPR	260	6-5/16" (160)	4-5/16" (109)	Precision Ball	SX-05AMX-125-TL-HK01
5	1-1/4	Polyurethane TPU	275	6-5/16" (160)	4-5/16" (109)	Precision Ball	SX-05PYX-125-TL-HK01
6	1-1/4	Thermoplastic Rubber	300	7-9/32" (185)	4-3/4" (119)	Precision Ball	SX-06TPX-125-TL-HK01
6	1-1/4	Anti-Microbial TPR	260	7-9/32" (185)	4-3/4" (119)	Precision Ball	SX-06AMX-125-TL-HK01
6	1-1/4	Polyurethane TPU	300	7-9/32" (185)	4-3/4" (119)	Precision Ball	SX-06PYX-125-TL-HK01



**Total Lock**  
Red pedal.

## HOLLOW KINGPIN DIRECTION LOCK MODELS (LOCKS SWIVEL ONLY)

Wheel Diameter (Inches)	Tread Width (Inches)	Wheel Description	Capacity (Lbs)	Load Height Inches (mm)	Swivel Radius Inches (mm)	Wheel Bearing	Model Number
3	1-1/4	Thermoplastic Rubber	220	4-5/16" (109)	4-1/4" (107)	Precision Ball	SX-03TPX-125-DL-HK01
3	1-1/4	Anti-Microbial TPR	190	4-5/16" (109)	4-1/4" (107)	Precision Ball	SX-03AMX-125-DL-HK01
3	1-1/4	Polyurethane TPU	220	4-5/16" (109)	4-1/4" (107)	Precision Ball	SX-03PYX-125-DL-HK01
4	1-1/4	Thermoplastic Rubber	240	5-5/16" (135)	4-3/16" (106)	Precision Ball	SX-04TPX-125-DL-HK01
4	1-1/4	Anti-Microbial TPR	240	5-5/16" (135)	4-3/16" (106)	Precision Ball	SX-04AMX-125-DL-HK01
4	1-1/4	Polyurethane TPU	240	5-5/16" (135)	4-3/16" (106)	Precision Ball	SX-04PYX-125-DL-HK01
5	1-1/4	Thermoplastic Rubber	275	6-5/16" (160)	4-5/16" (109)	Precision Ball	SX-05TPX-125-DL-HK01
5	1-1/4	Anti-Microbial TPR	260	6-5/16" (160)	4-5/16" (109)	Precision Ball	SX-05AMX-125-DL-HK01
5	1-1/4	Polyurethane TPU	275	6-5/16" (160)	4-5/16" (109)	Precision Ball	SX-05PYX-125-DL-HK01
6	1-1/4	Thermoplastic Rubber	300	7-9/32" (185)	4-3/4" (119)	Precision Ball	SX-06TPX-125-DL-HK01
6	1-1/4	Anti-Microbial TPR	260	7-9/32" (185)	4-3/4" (119)	Precision Ball	SX-06AMX-125-DL-HK01
6	1-1/4	Polyurethane TPU	300	7-9/32" (185)	4-3/4" (119)	Precision Ball	SX-06PYX-125-DL-HK01



**Direction Lock**  
Green pedal.

## HOLLOW KINGPIN

Caster is **provided assembled**. If you will be using your choice of fitting and would like these casters unassembled, change suffix to **HKU1**. 1/2 I.D.



**NEW Delrin:** Change bearing code to "N"  
(Example : SX-03TPN-125-SW-HK01)

# STAINLESS HOSPITAL (SX)

## THREADED STEM MODELS

FREE SWIVEL • TOTAL LOCK • DIRECTION LOCK

**NEW**



Polyurethane TPU wheel  
SX-05PYX-125-SW-TS02



Anti-microbial TPR wheel with total lock  
SX-05AMX-125-TL-TS02

### APPLICATIONS

- Food Service
- Case Carts
- Utility Carts
- Hospital Equipment
- Institutional Equipment
- Store Fixtures
- Medical equipment

### FEATURES

- Stainless Plated Finish
- **NEW** double pedal brake design for easy on/off function for both total lock and direction lock casters
- Dual ball heat treated raceways for added strength
- **Total Lock Brake** models lock both swivel and wheel
- Directional lock models lock swivel only (helps with steering)
- Precision ball bearings in wheels for easier rollability
- Wheels have full thread guards for added protection
- Comes standard with upper raceway seal

The SX series brings you stainless institutional casters at an affordable price.

## THREADED STEM MODELS

Wheel Diameter (Inches)	Tread Width (Inches)	Wheel Description	Capacity (Lbs)	Load Height Inches (mm)	Swivel Radius Inches (mm)	Wheel Bearing	Model Number
3	1-1/4	Thermoplastic Rubber	220	4-5/16" (109)	3-1/4" (83)	Precision Ball	SX-03TPX-125-SW-TS02
3	1-1/4	Anti-Microbial TPR	190	4-5/16" (109)	3-1/4" (83)	Precision Ball	SX-03AMX-125-SW-TS02
3	1-1/4	Polyurethane TPU	220	4-5/16" (109)	3-1/4" (83)	Precision Ball	SX-03PYX-125-SW-TS02
4	1-1/4	Thermoplastic Rubber	240	5-5/16" (135)	3-3/4" (95)	Precision Ball	SX-04TPX-125-SW-TS02
4	1-1/4	Anti-Microbial TPR	240	5-5/16" (135)	3-3/4" (95)	Precision Ball	SX-04AMX-125-SW-TS02
4	1-1/4	Polyurethane TPU	240	5-5/16" (135)	3-3/4" (95)	Precision Ball	SX-04PYX-125-SW-TS02
5	1-1/4	Thermoplastic Rubber	275	6-5/16" (160)	4-1/4" (108)	Precision Ball	SX-05TPX-125-SW-TS02
5	1-1/4	Anti-Microbial TPR	260	6-5/16" (160)	4-1/4" (108)	Precision Ball	SX-05AMX-125-SW-TS02
5	1-1/4	Polyurethane TPU	275	6-5/16" (160)	4-1/4" (108)	Precision Ball	SX-05PYX-125-SW-TS02
6	1-1/4	Thermoplastic Rubber	300	7-9/32" (185)	4-5/8" (117)	Precision Ball	SX-06TPX-125-SW-TS02
6	1-1/4	Anti-Microbial TPR	260	7-9/32" (185)	4-5/8" (117)	Precision Ball	SX-06AMX-125-SW-TS02
6	1-1/4	Polyurethane TPU	300	7-9/32" (185)	4-5/8" (117)	Precision Ball	SX-06PYX-125-SW-TS02



## THREADED STEM FITTING

TS12



**NEW** Delrin: Change bearing code to "N"  
(Example : SX-03TPN-125-SW-TS12)

# STAINLESS HOSPITAL (SX)

## THREADED STEM TOTAL LOCK MODELS (LOCKS WHEEL AND SWIVEL)

Wheel Diameter (Inches)	Tread Width (Inches)	Wheel Description	Capacity (Lbs)	Load Height Inches (mm)	Swivel Radius Inches (mm)	Wheel Bearing	Model Number
3	1-1/4	Thermoplastic Rubber	220	4-5/16" (109)	4-1/4" (107)	Precision Ball	SX-03TPX-125-TL-TS02
3	1-1/4	Anti-Microbial TPR	190	4-5/16" (109)	4-1/4" (107)	Precision Ball	SX-03AMX-125-TL-TS02
3	1-1/4	Polyurethane TPU	220	4-5/16" (109)	4-1/4" (107)	Precision Ball	SX-03PYX-125-TL-TS02
4	1-1/4	Thermoplastic Rubber	240	5-5/16" (135)	4-3/16" (106)	Precision Ball	SX-04TPX-125-TL-TS02
4	1-1/4	Anti-Microbial TPR	240	5-5/16" (135)	4-3/16" (106)	Precision Ball	SX-04AMX-125-TL-TS02
4	1-1/4	Polyurethane TPU	240	5-5/16" (135)	4-3/16" (106)	Precision Ball	SX-04PYX-125-TL-TS02
5	1-1/4	Thermoplastic Rubber	275	6-5/16" (160)	4-5/16" (109)	Precision Ball	SX-05TPX-125-TL-TS02
5	1-1/4	Anti-Microbial TPR	260	6-5/16" (160)	4-5/16" (109)	Precision Ball	SX-05AMX-125-TL-TS02
5	1-1/4	Polyurethane TPU	275	6-5/16" (160)	4-5/16" (109)	Precision Ball	SX-05PYX-125-TL-TS02
6	1-1/4	Thermoplastic Rubber	300	7-9/32" (185)	4-3/4" (119)	Precision Ball	SX-06TPX-125-TL-TS02
6	1-1/4	Anti-Microbial TPR	260	7-9/32" (185)	4-3/4" (119)	Precision Ball	SX-06AMX-125-TL-TS02
6	1-1/4	Polyurethane TPU	300	7-9/32" (185)	4-3/4" (119)	Precision Ball	SX-06PYX-125-TL-TS02



**Total Lock**  
Red pedal.

## THREADED STEM DIRECTION LOCK MODELS (LOCKS SWIVEL ONLY)

Wheel Diameter (Inches)	Tread Width (Inches)	Wheel Description	Capacity (Lbs)	Load Height Inches (mm)	Swivel Radius Inches (mm)	Wheel Bearing	Model Number
3	1-1/4	Thermoplastic Rubber	220	4-5/16" (109)	4-1/4" (107)	Precision Ball	SX-03TPX-125-DL-TS02
3	1-1/4	Anti-Microbial TPR	190	4-5/16" (109)	4-1/4" (107)	Precision Ball	SX-03AMX-125-DL-TS02
3	1-1/4	Polyurethane TPU	220	4-5/16" (109)	4-1/4" (107)	Precision Ball	SX-03PYX-125-DL-TS02
4	1-1/4	Thermoplastic Rubber	240	5-5/16" (135)	4-3/16" (106)	Precision Ball	SX-04TPX-125-DL-TS02
4	1-1/4	Anti-Microbial TPR	240	5-5/16" (135)	4-3/16" (106)	Precision Ball	SX-04AMX-125-DL-TS02
4	1-1/4	Polyurethane TPU	240	5-5/16" (135)	4-3/16" (106)	Precision Ball	SX-04PYX-125-DL-TS02
5	1-1/4	Thermoplastic Rubber	275	6-5/16" (160)	4-5/16" (109)	Precision Ball	SX-05TPX-125-DL-TS02
5	1-1/4	Anti-Microbial TPR	260	6-5/16" (160)	4-5/16" (109)	Precision Ball	SX-05AMX-125-DL-TS02
5	1-1/4	Polyurethane TPU	275	6-5/16" (160)	4-5/16" (109)	Precision Ball	SX-05PYX-125-DL-TS02
6	1-1/4	Thermoplastic Rubber	300	7-9/32" (185)	4-3/4" (119)	Precision Ball	SX-06TPX-125-DL-TS02
6	1-1/4	Anti-Microbial TPR	260	7-9/32" (185)	4-3/4" (119)	Precision Ball	SX-06AMX-125-DL-TS02
6	1-1/4	Polyurethane TPU	300	7-9/32" (185)	4-3/4" (119)	Precision Ball	SX-06PYX-125-DL-TS02



**Direction Lock**  
Green pedal.

Stems ship with a loose bolt for easier alignment of the directional lock.

## THREADED STEM FITTING

TS12



**NEW Delrin:** Change bearing code to "N"  
(Example : SX-03TPN-125-SW-TS12)

# AUTOCLAVE (AC)

## TOP PLATE MODELS

FREE SWIVEL • RIGID • TOP LOCK BRAKE



- APPLICATIONS**
- Food Service
  - Case Carts
  - Utility Carts
  - Medical Equipment
  - Institutional Equipment
  - Laboratory Equipment
  - Animal Cages
  - Pharmaceutical Equipment

- FEATURES**
- 304 Stainless Steel, Polished
  - Temperature range 250°F intermittently
  - Dual Ball Swivel Raceways for added strength
  - High temp swivel seals are standard
  - Stainless steel zerk fittings in swivel raceway
  - Stainless steel precision ball or rollerbearings in wheels for easier rollability
  - Wheels have plastic thread guards for added protection

Our AC series is constructed of quality 304 stainless steel. Caster is specially designed for many different medical and pharmaceutical applications such as autoclavable applications.



## SWIVEL TOP PLATE MODELS

Wheel Diameter (Inches)	Tread Width (Inches)	Wheel Description	Capacity (Lbs)	Load Height Inches (mm)	Swivel Radius Inches (mm)	Wheel Bearing	Model Number
4	1-1/4	Hytrel on Autoclaveable PP	275	5-7/16	3-37/64	Stainless Precision Ball	AC-04HSP-125-SW-_____
4	1-1/4	HI- Temp Phenolic	275	5-7/16	3-37/64	Stainless Roller	AC-04PHR-125-SW-_____
5	1-1/4	Hytrel on Autoclaveable PP	300	6-7/16	4-7/32	Stainless Precision Ball	AC-05HSP-125-SW-_____
5	1-1/4	HI- Temp Phenolic	300	6-7/16	4-7/32	Stainless Roller	AC-05PHR-125-SW-_____
6	1-1/4	Hytrel on Autoclaveable PP	325	7-13/32	4-39/64	Stainless Precision Ball	AC-06HSP-125-SW-_____
6	1-1/4	HI- Temp Phenolic	325	7-13/32	4-39/64	Stainless Roller	AC-06PHR-125-SW-_____

**Temperature Range**

Hytrel wheel....250°F intermittently  
Hi temp phenolic....300°F continuous

Specify fitting code, see fittings at left for dimensions.

### TOP PLATE

Swivel Top Plate Pattern

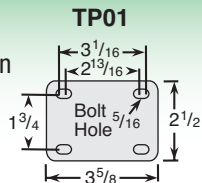

### SQUARE STEM

SQ05



# AUTOCLAVE (AC)



## RIGID TOP PLATE MODELS

Wheel Diameter (Inches)	Tread Width (Inches)	Wheel Description	Capacity (Lbs)	Load Height Inches (mm)	Swivel Radius Inches (mm)	Wheel Bearing	Model Number
4	1-1/4	Hytrel on Autoclaveable PP	275	5-7/16	N/A	Stainless Precision Ball	AC-04HSP-125-RG-____
4	1-1/4	HI- Temp Phenolic	275	5-7/16	N/A	Stainless Roller	AC-04PHR-125-RG-____
5	1-1/4	Hytrel on Autoclaveable PP	300	6-7/16	N/A	Stainless Precision Ball	AC-05HSP-125-RG-____
5	1-1/4	HI- Temp Phenolic	300	6-7/16	N/A	Stainless Roller	AC-05PHR-125-RG-____
6	1-1/4	Hytrel on Autoclaveable PP	325	7-13/32	N/A	Stainless Precision Ball	AC-06HSP-125-RG-____
6	1-1/4	HI- Temp Phenolic	325	7-13/32	N/A	Stainless Roller	AC-06PHR-125-RG-____



## SWIVEL TOP PLATE MODELS WITH TOP LOCK BRAKE

Wheel Diameter (Inches)	Tread Width (Inches)	Wheel Description	Capacity (Lbs)	Load Height Inches (mm)	Swivel Radius Inches (mm)	Wheel Bearing	Model Number
4	1-1/4	Hytrel on Autoclaveable PP	275	5-7/16	3-37/64	Stainless Precision Ball	AC-04HSP-125-TB-____
4	1-1/4	HI- Temp Phenolic	275	5-7/16	3-37/64	Stainless Roller	AC-04PHR-125-TB-____
5	1-1/4	Hytrel on Autoclaveable PP	300	6-7/16	4-7/32	Stainless Precision Ball	AC-05HSP-125-TB-____
5	1-1/4	HI- Temp Phenolic	300	6-7/16	4-7/32	Stainless Roller	AC-05PHR-125-TB-____
6	1-1/4	Hytrel on Autoclaveable PP	325	7-13/32	4-39/64	Stainless Precision Ball	AC-06HSP-125-TB-____
6	1-1/4	HI- Temp Phenolic	325	7-13/32	4-39/64	Stainless Roller	AC-06PHR-125-TB-____

Specify fitting code, see fittings at left for dimensions.

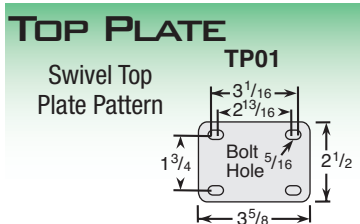

# "NG" Next Generation

## NYLON CASTERS – THE INSIDE STORY



3" thru 6" wheel diameters available.

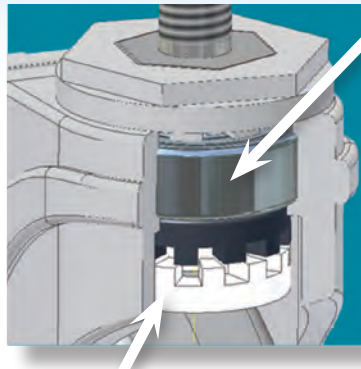

Direction and Total Lock braking action designed into caster.

**NG series** has precision sealed ball bearing raceway design for long lasting, smooth, quiet, maintenance free ride. Precision ball bearings are insert molded into the swivel raceway. Caster capacity is similar to steel wheels at a massive 325 lbs with 5" wheel.

### PERFORMANCE FEATURES

- QUIET
- CLEAN
- SMOOTH
- MAINTENANCE FREE
- HIGHER CAPACITY

Glass filled nylon for added strength and durability. Custom colors available.



Custom Colors Available

Sealed precision ball bearing is insert molded into the swivel raceway.

Wheels feature sealed precision ball bearings to provide a smooth, quiet and maintenance free ride.

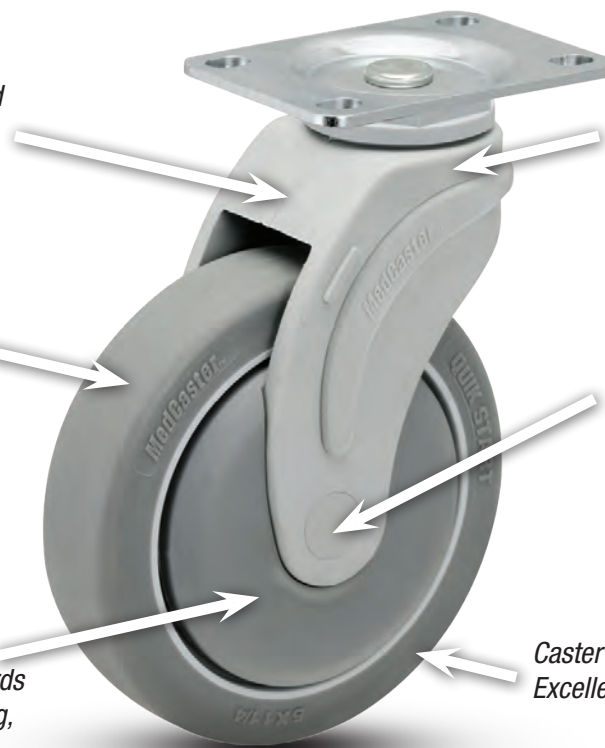

Recessed nut and bolt axles or rivet with covers.

Fully Integrated thread guards prevent the pick-up of string, sutures and foreign debris.

Caster is resistant to most chemicals. Excellent for wash down applications.

**NG NEXT GENERATION**



Page 64-75

**NG BRAKES & DIRECTION LOCKS**



Page 64-75

**NS STAINLESS**



Page 76-83

**NA ANTISTATIC**



Page 100

**NG ANTI-MICROBIAL**



Page 64-75

**NM NON-MAGNETIC**



Page 84-85

# MARQUE NYLON CASTERS (MP) IMPROVED

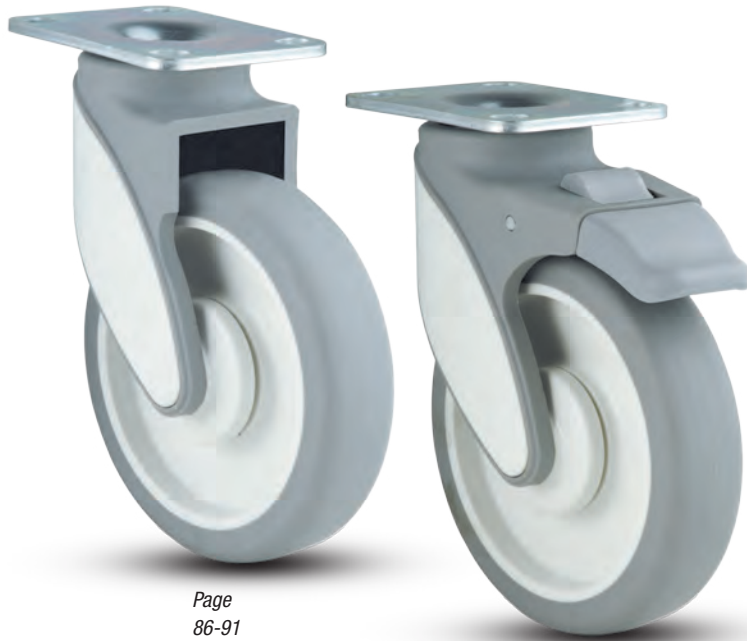

Page  
86-91

- APPLICATIONS**
- Food Service Equipment
  - Case Carts
  - Utility Carts
  - Medical Equipment
  - Institutional Equipment
  - Hospital Carts
  - Animal Cage Carts
  - Pharmaceutical Equipment

- FEATURES**
- Glass filled nylon body
  - New! Precision bearing raceway
  - Total lock and direction lock brake models available
  - Resistant to water and most chemicals
  - Precision bearing in wheel
  - Zinc plated top plate
  - Riveted axle



Custom colors available.  
Consult factory for minimums.

# PLASTIC SERIES CASTERS



**PG**  
Page  
92-27



**OP**  
Page  
17



# NEXT GENERATION NYLON (NG)

## TOP PLATE MODELS

FREE SWIVEL • TOTAL LOCK • DIRECTION LOCK



Free swivel with QuickStart TPR wheel:  
NG-05QDP-125-SW-TP01



Total Lock with Santoprene wheel  
NG-05RPP-125-TL-TP01

- APPLICATIONS**
- Food Service Equipment
  - Case Carts
  - Utility Carts
  - Medical Equipment
  - Institutional Equipment
  - Hospital Carts
  - Animal Cage Carts

- FEATURES**
- Maintenance free
  - Sealed precision bearing raceway, smooth and quiet
  - **Total Lock Brake** models lock both swivel and wheel
  - Directional lock models lock swivel only (helps with steering)
  - Wheels feature sealed precision ball bearings and full thread guards
  - Resistance to most chemicals
  - Zinc plated top plate
  - Recessed axle with plastic cap covers



Custom Colors Available

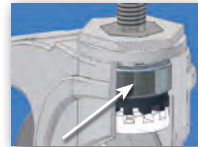

Precision sealed ball bearing raceway design for smooth, quiet maintenance free ride.

Our NG series is made of glass filled nylon for added strength and durability. Precision ball bearings are insert molded into the swivel raceway.

## SWIVEL TOP PLATE MODELS

Precision sealed ball bearing raceway design for smooth, quiet maintenance free ride.

Wheel Diameter (Inches)	Tread Width (Inches)	Wheel Description	Capacity (Lbs)	Load Height Inches (mm)	Swivel Radius Inches (mm)	Wheel Bearing	Model Number
3	1-1/4	QuikStart TPR	200	4-1/4" (108)	2-13/16" (72)	Precision Ball	NG-03QDP-125-SW-TP01
3	1-1/4	QuikStart TPR	200	4-1/4" (108)	2-13/16" (72)	Plain	NG-03QDO-125-SW-TP01
3	1-1/4	Anti-Microbial TPR	200	4-1/4" (108)	2-13/16" (72)	Precision Ball	NG-03AMP-125-SW-TP01
4	1-1/4	QuikStart TPR	275	5-3/4" (146)	3-7/16" (87)	Precision Ball	NG-04QDP-125-SW-TP01
4	1-1/4	Anti-Microbial TPR	275	5-3/4" (146)	3-7/16" (87)	Precision Ball	NG-04AMP-125-SW-TP01
5	1-1/4	Santoprene	260	6-7/8" (174)	4" (102)	Precision Ball	NG-05RPP-125-SW-TP01
5	1-1/4	QuikStart TPR	300	6-7/8" (174)	4" (102)	Precision Ball	NG-05QDP-125-SW-TP01
5	1-1/4	Anti-Microbial TPR	300	6-7/8" (174)	4" (102)	Precision Ball	NG-05AMP-125-SW-TP01
6	1-1/4	QuikStart TPR	300	7-11/16" (195)	4-9/16" (116)	Precision Ball	NG-06QDP-125-SW-TP01
6	1-1/4	QuikStart TPR	300	7-11/16" (195)	4-9/16" (116)	Plain	NG-06QDO-125-SW-TP01
6	1-1/4	Anti-Microbial TPR	300	7-11/16" (195)	4-9/16" (116)	Precision Ball	NG-06AMP-125-SW-TP01



Note: Antimicrobial casters (AMP) wheels have the darker grey fork and brighter wheel.



Rigid model available for 3", 5" and 6" diameter wheels. Change SW to RG.

## TOP PLATE FITTING

Swivel Top Plate Pattern

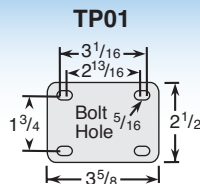



# NEXT GENERATION NYLON (NG)

## TOP PLATE MODELS

FREE SWIVEL • TOTAL LOCK • DIRECTION LOCK

### SWIVEL TOP PLATE TOTAL LOCK MODELS

(LOCKS WHEEL AND SWIVEL)

Precision sealed ball bearing raceway design for smooth, quiet maintenance free ride.

Wheel Diameter (Inches)	Tread Width (Inches)	Wheel Description	Capacity (lbs)	Load Height Inches (mm)	Swivel Radius Inches (mm)	Wheel Bearing	Model Number
3	1-1/4	QuikStart TPR	200	4-1/4" (108)	3-3/4" (95)	Precision Ball	NG-03QDP-125-TL-TP01
3	1-1/4	QuikStart TPR	200	4-1/4" (108)	3-3/4" (95)	Plain	NG-03QDO-125-TL-TP01
3	1-1/4	Anti-Microbial TPR	200	4-1/4" (108)	3-3/4" (95)	Precision Ball	NG-03AMP-125-TL-TP01
4	1-1/4	QuikStart TPR	275	5-3/4" (146)	4-7/16" (112)	Precision Ball	NG-04QDP-125-TL-TP01
4	1-1/4	Anti-Microbial TPR	275	5-3/4" (146)	4-7/16" (112)	Precision Ball	NG-04AMP-125-TL-TP01
5	1-1/4	Santoprene	260	6-7/8" (174)	4-7/16" (112)	Precision Ball	NG-05RPP-125-TL-TP01
5	1-1/4	QuikStart TPR	300	6-7/8" (174)	4-7/16" (112)	Precision Ball	NG-05QDP-125-TL-TP01
5	1-1/4	Anti-Microbial TPR	300	6-7/8" (174)	4-7/16" (112)	Precision Ball	NG-05AMP-125-TL-TP01
6	1-1/4	QuikStart TPR	300	7-11/16" (195)	4-9/16" (116)	Precision Ball	NG-06QDP-125-TL-TP01
6	1-1/4	QuikStart TPR	300	7-11/16" (195)	4-9/16" (116)	Plain	NG-06QDO-125-TL-TP01
6	1-1/4	Anti-Microbial TPR	300	7-11/16" (195)	4-9/16" (116)	Precision Ball	NG-06AMP-125-TL-TP01



### SWIVEL TOP PLATE DIRECTION LOCK MODELS

(LOCKS SWIVEL ONLY)

Precision sealed ball bearing raceway design for smooth, quiet maintenance free ride.

Wheel Diameter (Inches)	Tread Width (Inches)	Wheel Description	Capacity (lbs)	Load Height Inches (mm)	Swivel Radius Inches (mm)	Wheel Bearing	Model Number
3	1-1/4	QuikStart TPR	200	4-1/4" (108)	3-3/4" (95)	Precision Ball	NG-03QDP-125-DL-TP01
3	1-1/4	QuikStart TPR	200	4-1/4" (108)	3-3/4" (95)	Plain	NG-03QDO-125-DL-TP01
3	1-1/4	Anti-Microbial TPR	200	4-1/4" (108)	3-3/4" (95)	Precision Ball	NG-03AMP-125-DL-TP01
4	1-1/4	QuikStart TPR	275	5-3/4" (146)	4-7/16" (112)	Precision Ball	NG-04QDP-125-DL-TP01
4	1-1/4	Anti-Microbial TPR	275	5-3/4" (146)	4-7/16" (112)	Precision Ball	NG-04AMP-125-DL-TP01
5	1-1/4	Santoprene	260	6-7/8" (174)	4-7/16" (112)	Precision Ball	NG-05RPP-125-DL-TP01
5	1-1/4	QuikStart TPR	300	6-7/8" (174)	4-7/16" (112)	Precision Ball	NG-05QDP-125-DL-TP01
5	1-1/4	Anti-Microbial TPR	300	6-7/8" (174)	4-7/16" (112)	Precision Ball	NG-05AMP-125-DL-TP01
6	1-1/4	QuikStart TPR	300	7-11/16" (195)	4-9/16" (116)	Precision Ball	NG-06QDP-125-DL-TP01
6	1-1/4	QuikStart TPR	300	7-11/16" (195)	4-9/16" (116)	Plain	NG-06QDO-125-DL-TP01
6	1-1/4	Anti-Microbial TPR	300	7-11/16" (195)	4-9/16" (116)	Precision Ball	NG-06AMP-125-DL-TP01



Our Directional Lock casters are designed to lock the swivel but not the wheel allowing you to steer your equipment. The directional lock feature is designed to break free under heavier load when the unit is traversing a corner only to lock back into position when the unit resumes a straight course.

### TOP PLATE FITTING

Swivel Top Plate Pattern

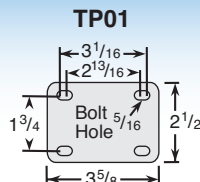

New rigid brake models now available on 5" models. Change TL to RB

# NEXT GENERATION NYLON (NG)

HOLLOW KINGPIN MODELS  
FREE SWIVEL • TOTAL LOCK • DIRECTION LOCK



Free swivel with Santoprene wheel  
NG-05RPP-125-SW-HKU1



Direction Lock with QuickStart TPR wheel  
NG-05QDP-125-DL-HKU1

- APPLICATIONS**
- Food Service Equipment
  - Case Carts
  - Utility Carts
  - Medical Equipment
  - Institutional Equipment
  - Hospital Carts
  - Animal Cage Carts



Custom Colors Available

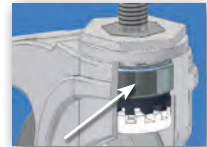

Precision sealed ball bearing raceway design for smooth, quiet maintenance free ride.

- FEATURES**
- Maintenance free
  - Sealed precision bearing raceway, smooth and quiet
  - **Total Lock Brake** models lock both swivel and wheel
  - Directional lock models lock swivel only (helps with steering)
  - Wheels feature sealed precision ball bearings and full thread guards
  - Resistance to most chemicals
  - Zinc plated top plate
  - Recessed axle with plastic cap covers

Our NG series is made of glass filled nylon for added strength and durability. Precision ball bearings are insert molded into the swivel raceway.

## HOLLOW KINGPIN MODELS

Precision sealed ball bearing raceway design for smooth, quiet maintenance free ride.

Wheel Diameter (Inches)	Tread Width (Inches)	Wheel Description	Capacity (Lbs)	Load Height Inches (mm)	Swivel Radius Inches (mm)	Wheel Bearing	Model Number
3	1-1/4	QuikStart TPR	200	4-7/32" (107)	2-13/16" (72)	Precision Ball	NG-03QDP-125-SW-HKU4
3	1-1/4	QuikStart TPR	200	4-7/32" (107)	2-13/16" (72)	Plain	NG-03QDO-125-SW-HKU4
3	1-1/4	Anti-Microbial TPR	200	4-7/32" (107)	2-13/16" (72)	Precision Ball	NG-03AMP-125-SW-HKU4
4	1-1/4	QuikStart TPR	275	5-13/32" (137)	3-7/16" (87)	Precision Ball	NG-04QDP-125-SW-HKU1
4	1-1/4	Anti-Microbial TPR	275	5-13/32" (137)	3-7/16" (87)	Precision Ball	NG-04AMP-125-SW-HKU1
5	1-1/4	Santoprene	260	6-1/2" (165)	4" (102)	Precision Ball	NG-05RPP-125-SW-HKU1
5	1-1/4	QuikStart TPR	300	6-1/2" (165)	4" (102)	Precision Ball	NG-05QDP-125-SW-HKU1
5	1-1/4	Anti-Microbial TPR	300	6-1/2" (165)	4" (102)	Precision Ball	NG-05AMP-125-SW-HKU1
6	1-1/4	QuikStart TPR	300	7-1/2" (191)	4-9/16" (116)	Precision Ball	NG-06QDP-125-SW-HKU1
6	1-1/4	QuikStart TPR	300	7-1/2" (191)	4-9/16" (116)	Plain	NG-06QDO-125-SW-HKU1
6	1-1/4	Anti-Microbial TPR	300	7-1/2" (191)	4-9/16" (116)	Precision Ball	NG-06AMP-125-SW-HKU1



Note: Antimicrobial casters (AMP) wheels have the darker grey fork and brighter wheel.



Rigid model available for 3", 5" and 6" diameter wheels. Change SW to RG.

## HOLLOW KINGPIN

Caster is **provided unassembled** to make it easy to add your choice of fitting. If you would like these assembled change **HKU4** to **HK04** on 3" diameter models, Change **HKU1** to **HK01** on 4" to 6" diameter models. 3/8" I.D. on 3" diam. models; 1/2" I.D. on 4", 5", & 6" diam. models.



# NEXT GENERATION NYLON (NG)

HOLLOW KINGPIN MODELS  
FREE SWIVEL • TOTAL LOCK • DIRECTION LOCK

## HOLLOW KINGPIN TOTAL LOCK MODELS

(LOCKS WHEEL AND SWIVEL)

Precision sealed ball bearing raceway design for smooth, quiet maintenance free ride.

Wheel Diameter (Inches)	Tread Width (Inches)	Wheel Description	Capacity (Lbs)	Load Height Inches (mm)	Swivel Radius Inches (mm)	Wheel Bearing	Model Number
3	1-1/4	QuikStart TPR	200	4-7/32" (107)	3-3/4" (95)	Precision Ball	NG-03QDP-125-TL-HKU4
3	1-1/4	QuikStart TPR	200	4-7/32" (107)	3-3/4" (95)	Plain	NG-03QDO-125-TL-HKU4
3	1-1/4	Anti-Microbial TPR	200	4-7/32" (107)	3-3/4" (95)	Precision Ball	NG-03AMP-125-TL-HKU4
4	1-1/4	QuikStart TPR	275	5-13/32" (137)	4-7/16" (112)	Precision Ball	NG-04QDP-125-TL-HKU1
4	1-1/4	Anti-Microbial TPR	275	5-13/32" (137)	4-7/16" (112)	Precision Ball	NG-04AMP-125-TL-HKU1
5	1-1/4	Santoprene	260	6-1/2" (165)	4-7/16" (112)	Precision Ball	NG-05RPP-125-TL-HKU1
5	1-1/4	QuikStart TPR	300	6-1/2" (165)	4-7/16" (112)	Precision Ball	NG-05QDP-125-TL-HKU1
5	1-1/4	Anti-Microbial TPR	300	6-1/2" (165)	4-7/16" (112)	Precision Ball	NG-05AMP-125-TL-HKU1
6	1-1/4	QuikStart TPR	300	7-1/2" (191)	4-9/16" (116)	Precision Ball	NG-06QDP-125-TL-HKU1
6	1-1/4	QuikStart TPR	300	7-1/2" (191)	4-9/16" (116)	Plain	NG-06QDO-125-TL-HKU1
6	1-1/4	Anti-Microbial TPR	300	7-1/2" (191)	4-9/16" (116)	Precision Ball	NG-06AMP-125-TL-HKU1



## HOLLOW KINGPIN DIRECTION LOCK MODELS

(LOCKS SWIVEL ONLY)

Precision sealed ball bearing raceway design for smooth, quiet maintenance free ride.

Wheel Diameter (Inches)	Tread Width (Inches)	Wheel Description	Capacity (Lbs)	Load Height Inches (mm)	Swivel Radius Inches (mm)	Wheel Bearing	Model Number
3	1-1/4	QuikStart TPR	200	4-7/32" (107)	3-3/4" (95)	Precision Ball	NG-03QDP-125-DL-HKU4
3	1-1/4	QuikStart TPR	200	4-7/32" (107)	3-3/4" (95)	Plain	NG-03QDO-125-DL-HKU4
3	1-1/4	Anti-Microbial TPR	200	4-7/32" (107)	3-3/4" (95)	Precision Ball	NG-03AMP-125-DL-HKU4
4	1-1/4	QuikStart TPR	275	5-13/32" (137)	4-7/16" (112)	Precision Ball	NG-04QDP-125-DL-HKU1
4	1-1/4	Anti-Microbial TPR	275	5-13/32" (137)	4-7/16" (112)	Precision Ball	NG-04AMP-125-DL-HKU1
5	1-1/4	Santoprene	260	6-1/2" (165)	4-7/16" (112)	Precision Ball	NG-05RPP-125-DL-HKU1
5	1-1/4	QuikStart TPR	300	6-1/2" (165)	4-7/16" (112)	Precision Ball	NG-05QDP-125-DL-HKU1
5	1-1/4	Anti-Microbial TPR	300	6-1/2" (165)	4-7/16" (112)	Precision Ball	NG-05AMP-125-DL-HKU1
6	1-1/4	QuikStart TPR	300	7-1/2" (191)	4-9/16" (116)	Precision Ball	NG-06QDP-125-DL-HKU1
6	1-1/4	QuikStart TPR	300	7-1/2" (191)	4-9/16" (116)	Plain	NG-06QDO-125-DL-HKU1
6	1-1/4	Anti-Microbial TPR	300	7-1/2" (191)	4-9/16" (116)	Precision Ball	NG-06AMP-125-DL-HKU1



Our Directional Lock casters are designed to lock the swivel but not the wheel allowing you to steer your equipment. The directional lock feature is designed to break free under heavier load when the unit is traversing a corner only to lock back into position when the unit resumes a straight course.



New rigid brake models now available on 5" models. Change TL to RB

## HOLLOW KINGPIN

Caster is **provided unassembled** to make it easy to add your choice of fitting. If you would like these assembled change **HKU4** to **HK04** on 3" diameter models, Change **HKU1** to **HK01** on 4" to 6" diameter models. 3/8" I.D. on 3" diam. models; 1/2" I.D. on 4", 5", & 6" diam. models.



# NEXT GENERATION NYLON (NG)

GRIP RING STEM MODELS  
FREE SWIVEL • TOTAL LOCK • DIRECTION LOCK



Free swivel with QuickStart TPR wheel:  
NG-05QDP-125-SW-GR02



Total Lock with Santoprene wheel  
NG-05RPP-125-TL-GR02

- APPLICATIONS**
- Food Service Equipment
  - Case Carts
  - Utility Carts
  - Medical Equipment
  - Institutional Equipment
  - Hospital Carts
  - Animal Cage Carts

- FEATURES**
- Maintenance free
  - Sealed precision bearing raceway, smooth and quiet
  - **Total Lock Brake** models lock both swivel and wheel
  - Directional lock models lock swivel only (helps with steering)
  - Wheels feature sealed precision ball bearings and full thread guards
  - Resistance to most chemicals
  - Zinc plated top plate
  - Recessed axle with plastic cap covers



Custom Colors Available

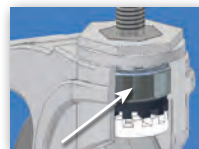

Precision sealed ball bearing raceway design for smooth, quiet maintenance free ride.

Our NG series is made of glass filled nylon for added strength and durability. Precision ball bearings are insert molded into the swivel raceway.

## GRIP RING STEM MODELS

Precision sealed ball bearing raceway design for smooth, quiet maintenance free ride.

Wheel Diameter (Inches)	Tread Width (Inches)	Wheel Description	Capacity (Lbs)	Load Height Inches (mm)	Swivel Radius Inches (mm)	Wheel Bearing	Model Number
3	1-1/4	QuikStart TPR	200	4-7/32" (107)	2-13/16" (72)	Precision Ball	NG-03QDP-125-SW-_____
3	1-1/4	QuikStart TPR	200	4-7/32" (107)	2-13/16" (72)	Plain	NG-03QDO-125-SW-_____
3	1-1/4	Anti-Microbial TPR	200	4-7/32" (107)	2-13/16" (72)	Precision Ball	NG-03AMP-125-SW-_____
4	1-1/4	QuikStart TPR	275	5-13/32" (137)	3-7/16" (87)	Precision Ball	NG-04QDP-125-SW-_____
4	1-1/4	Anti-Microbial TPR	275	5-13/32" (137)	3-7/16" (87)	Precision Ball	NG-04AMP-125-SW-_____
5	1-1/4	Santoprene	260	6-1/2" (165)	4" (102)	Precision Ball	NG-05RPP-125-SW-_____
5	1-1/4	QuikStart TPR	300	6-1/2" (165)	4" (102)	Precision Ball	NG-05QDP-125-SW-_____
5	1-1/4	Anti-Microbial TPR	300	6-1/2" (165)	4" (102)	Precision Ball	NG-05AMP-125-SW-_____
6	1-1/4	QuikStart TPR	300	7-1/2" (191)	4-9/16" (116)	Precision Ball	NG-06QDP-125-SW-_____
6	1-1/4	QuikStart TPR	300	7-1/2" (191)	4-9/16" (116)	Plain	NG-06QDO-125-SW-_____
6	1-1/4	Anti-Microbial TPR	300	7-1/2" (191)	4-9/16" (116)	Precision Ball	NG-06AMP-125-SW-_____



Note: Antimicrobial casters (AMP) wheels have the darker grey fork and brighter wheel.

Specify Grip Ring Stem (GR) code, see fittings below for dimensions.

## GRIP RING STEM FITTINGS

See fittings page for more options.

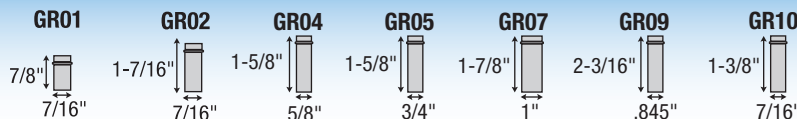

# NEXT GENERATION NYLON (NG)

GRIP RING STEM MODELS  
FREE SWIVEL • TOTAL LOCK • DIRECTION LOCK

## GRIP RING STEM TOTAL LOCK MODELS

(LOCKS WHEEL AND SWIVEL)

Precision sealed ball bearing raceway design for smooth, quiet maintenance free ride.

Wheel Diameter (Inches)	Tread Width (Inches)	Wheel Description	Capacity (lbs)	Load Height Inches (mm)	Swivel Radius Inches (mm)	Wheel Bearing	Model Number
3	1-1/4	QuikStart TPR	200	4-7/32" (107)	3-3/4" (95)	Precision Ball	NG-03QDP-125-TL-____
3	1-1/4	QuikStart TPR	200	4-7/32" (107)	3-3/4" (95)	Plain	NG-03QDO-125-TL-____
3	1-1/4	Anti-Microbial TPR	200	4-7/32" (107)	3-3/4" (95)	Precision Ball	NG-03AMP-125-TL-____
4	1-1/4	QuikStart TPR	275	5-13/32" (137)	4-7/16" (112)	Precision Ball	NG-04QDP-125-TL-____
4	1-1/4	Anti-Microbial TPR	275	5-13/32" (137)	4-7/16" (112)	Precision Ball	NG-04AMP-125-TL-____
5	1-1/4	Santoprene	260	6-1/2" (165)	4-7/16" (112)	Precision Ball	NG-05RPP-125-TL-____
5	1-1/4	QuikStart TPR	300	6-1/2" (165)	4-7/16" (112)	Precision Ball	NG-05QDP-125-TL-____
5	1-1/4	Anti-Microbial TPR	300	6-1/2" (165)	4-7/16" (112)	Precision Ball	NG-05AMP-125-TL-____
6	1-1/4	QuikStart TPR	300	7-1/2" (191)	4-9/16" (116)	Precision Ball	NG-06QDP-125-TL-____
6	1-1/4	QuikStart TPR	300	7-1/2" (191)	4-9/16" (116)	Plain	NG-06QDO-125-TL-____
6	1-1/4	Anti-Microbial TPR	300	7-1/2" (191)	4-9/16" (116)	Precision Ball	NG-06AMP-125-TL-____



## GRIP RING STEM DIRECTION LOCK MODELS

(LOCKS SWIVEL ONLY)

Wheel Diameter (Inches)	Tread Width (Inches)	Wheel Description	Capacity (lbs)	Load Height Inches (mm)	Swivel Radius Inches (mm)	Wheel Bearing	Model Number
3	1-1/4	QuikStart TPR	200	4-7/32" (107)	3-3/4" (95)	Precision Ball	NG-03QDP-125-DL-____
3	1-1/4	QuikStart TPR	200	4-7/32" (107)	3-3/4" (95)	Plain	NG-03QDO-125-DL-____
3	1-1/4	Anti-Microbial TPR	200	4-7/32" (107)	3-3/4" (95)	Precision Ball	NG-03AMP-125-DL-____
4	1-1/4	QuikStart TPR	275	5-13/32" (137)	4-7/16" (112)	Precision Ball	NG-04QDP-125-DL-____
4	1-1/4	Anti-Microbial TPR	275	5-13/32" (137)	4-7/16" (112)	Precision Ball	NG-04AMP-125-DL-____
5	1-1/4	Santoprene	260	6-1/2" (165)	4-7/16" (112)	Precision Ball	NG-05RPP-125-DL-____
5	1-1/4	QuikStart TPR	300	6-1/2" (165)	4-7/16" (112)	Precision Ball	NG-05QDP-125-DL-____
5	1-1/4	Anti-Microbial TPR	300	6-1/2" (165)	4-7/16" (112)	Precision Ball	NG-05AMP-125-DL-____
6	1-1/4	QuikStart TPR	300	7-1/2" (191)	4-9/16" (116)	Precision Ball	NG-06QDP-125-DL-____
6	1-1/4	QuikStart TPR	300	7-1/2" (191)	4-9/16" (116)	Plain	NG-06QDO-125-DL-____
6	1-1/4	Anti-Microbial TPR	300	7-1/2" (191)	4-9/16" (116)	Precision Ball	NG-06AMP-125-DL-____



Our Directional Lock casters are designed to lock the swivel but not the wheel allowing you to steer your equipment. The directional lock feature is designed to break free under heavier load when the unit is traversing a corner only to lock back into position when the unit resumes a straight course.

Stems ship with a loose bolt for easier alignment of the directional lock. The direction lock caster will not remain in a fixed position when used with a grip ring stem.

Specify Grip Ring Stem (GR) code, see fittings below for dimensions.

## GRIP RING STEM FITTINGS

See fittings page for more options.

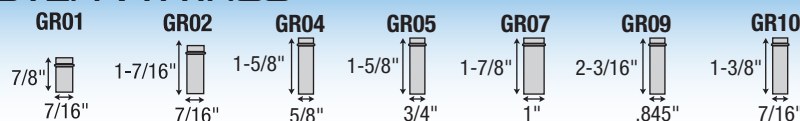

# NEXT GENERATION NYLON (NG)

EXPANDING ADAPTER STEM MODELS  
 FREE SWIVEL • TOTAL LOCK • DIRECTION LOCK



Free swivel with Santoprene wheel  
 NG-05RPP-125-SW-XRN1

Direction Lock with QuickStart TPR wheel  
 NG-05QDP-125-DL-XRZ4

- APPLICATIONS**
- Food Service Equipment
  - Case Carts
  - Utility Carts
  - Medical Equipment
  - Institutional Equipment
  - Hospital Carts
  - Animal Cage Carts

- FEATURES**
- Maintenance free
  - Sealed precision bearing raceway, smooth and quiet
  - **Total Lock Brake** models lock both swivel and wheel
  - Directional lock models lock swivel only (helps with steering)
  - Wheels feature sealed precision ball bearings and full thread guards
  - Resistance to most chemicals
  - Zinc plated top plate
  - Recessed axle with plastic cap covers



Custom Colors Available

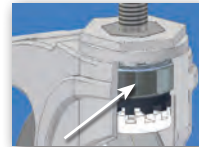

Precision sealed ball bearing raceway design for smooth, quiet maintenance free ride.

Our NG series is made of glass filled nylon for added strength and durability. Precision ball bearings are insert molded into the swivel raceway.

## EXPANDING ADAPTER STEM MODELS

Precision sealed ball bearing raceway design for smooth, quiet maintenance free ride.

Wheel Diameter (Inches)	Tread Width (Inches)	Wheel Description	Capacity (Lbs)	Load Height Inches (mm)	Swivel Radius Inches (mm)	Wheel Bearing	Model Number
3	1-1/4	QuikStart TPR	200	4-7/32" (107)	2-13/16" (72)	Precision Ball	NG-03QDP-125-SW-_____
3	1-1/4	QuikStart TPR	200	4-7/32" (107)	2-13/16" (72)	Plain	NG-03QDO-125-SW-_____
3	1-1/4	Anti-Microbial TPR	200	4-7/32" (107)	2-13/16" (72)	Precision Ball	NG-03AMP-125-SW-_____
4	1-1/4	QuikStart TPR	275	5-13/32" (137)	3-7/16" (87)	Precision Ball	NG-04QDP-125-SW-_____
4	1-1/4	Anti-Microbial TPR	275	5-13/32" (137)	3-7/16" (87)	Precision Ball	NG-04AMP-125-SW-_____
5	1-1/4	Santoprene	260	6-1/2" (165)	4" (102)	Precision Ball	NG-05RPP-125-SW-_____
5	1-1/4	QuikStart TPR	300	6-1/2" (165)	4" (102)	Precision Ball	NG-05QDP-125-SW-_____
5	1-1/4	Anti-Microbial TPR	300	6-1/2" (165)	4" (102)	Precision Ball	NG-05AMP-125-SW-_____
6	1-1/4	QuikStart TPR	300	7-1/2" (191)	4-9/16" (116)	Precision Ball	NG-06QDP-125-SW-_____
6	1-1/4	QuikStart TPR	300	7-1/2" (191)	4-9/16" (116)	Plain	NG-06QDO-125-SW-_____
6	1-1/4	Anti-Microbial TPR	300	7-1/2" (191)	4-9/16" (116)	Precision Ball	NG-06AMP-125-SW-_____



Note: Antimicrobial casters (AMP) wheels have the darker grey fork and brighter wheel.

Specify Expanding Adapter Stem (XR) code, see fittings below for dimensions:

## EXPANDING ADAPTER STEM FITTINGS

See fittings page for more options.

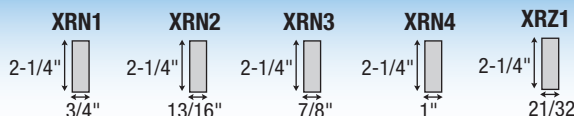

Consult factory for 3" diameter model expanding adapter stems.

# NEXT GENERATION NYLON (NG)

EXPANDING ADAPTER STEM MODELS  
 FREE SWIVEL • TOTAL LOCK • DIRECTION LOCK

## EXPANDING ADAPTER STEM TOTAL LOCK MODELS (LOCKS WHEEL AND SWIVEL)

Precision sealed ball bearing raceway design for smooth, quiet maintenance free ride.

Wheel Diameter (Inches)	Tread Width (Inches)	Wheel Description	Capacity (Lbs)	Load Height Inches (mm)	Swivel Radius Inches (mm)	Wheel Bearing	Model Number
3	1-1/4	QuikStart TPR	200	4-7/32" (107)	3-3/4" (95)	Precision Ball	NG-03QDP-125-TL-____
3	1-1/4	QuikStart TPR	200	4-7/32" (107)	3-3/4" (95)	Plain	NG-03QDO-125-TL-____
3	1-1/4	Anti-Microbial TPR	200	4-7/32" (107)	3-3/4" (95)	Precision Ball	NG-03AMP-125-TL-____
4	1-1/4	QuikStart TPR	275	5-13/32" (137)	4-7/16" (112)	Precision Ball	NG-04QDP-125-TL-____
4	1-1/4	Anti-Microbial TPR	275	5-13/32" (137)	4-7/16" (112)	Precision Ball	NG-04AMP-125-TL-____
5	1-1/4	Santoprene	260	6-1/2" (165)	4-7/16" (112)	Precision Ball	NG-05RPP-125-TL-____
5	1-1/4	QuikStart TPR	300	6-1/2" (165)	4-7/16" (112)	Precision Ball	NG-05QDP-125-TL-____
5	1-1/4	Anti-Microbial TPR	300	6-1/2" (165)	4-7/16" (112)	Precision Ball	NG-05AMP-125-TL-____
6	1-1/4	QuikStart TPR	300	7-1/2" (191)	4-9/16" (116)	Precision Ball	NG-06QDP-125-TL-____
6	1-1/4	QuikStart TPR	300	7-1/2" (191)	4-9/16" (116)	Plain	NG-06QDO-125-TL-____
6	1-1/4	Anti-Microbial TPR	300	7-1/2" (191)	4-9/16" (116)	Precision Ball	NG-06AMP-125-TL-____



## EXPANDING ADAPTER STEM DIRECTION LOCK MODELS (LOCKS SWIVEL ONLY)

Precision sealed ball bearing raceway design for smooth, quiet maintenance free ride.

Wheel Diameter (Inches)	Tread Width (Inches)	Wheel Description	Capacity (Lbs)	Load Height Inches (mm)	Swivel Radius Inches (mm)	Wheel Bearing	Model Number
3	1-1/4	QuikStart TPR	200	4-7/32" (107)	3-3/4" (95)	Precision Ball	NG-03QDP-125-DL-____
3	1-1/4	QuikStart TPR	200	4-7/32" (107)	3-3/4" (95)	Plain	NG-03QDO-125-DL-____
3	1-1/4	Anti-Microbial TPR	200	4-7/32" (107)	3-3/4" (95)	Precision Ball	NG-03AMP-125-DL-____
4	1-1/4	QuikStart TPR	275	5-13/32" (137)	4-7/16" (112)	Precision Ball	NG-04QDP-125-DL-____
4	1-1/4	Anti-Microbial TPR	275	5-13/32" (137)	4-7/16" (112)	Precision Ball	NG-04AMP-125-DL-____
5	1-1/4	Santoprene	260	6-1/2" (165)	4-7/16" (112)	Precision Ball	NG-05RPP-125-DL-____
5	1-1/4	QuikStart TPR	300	6-1/2" (165)	4-7/16" (112)	Precision Ball	NG-05QDP-125-DL-____
5	1-1/4	Anti-Microbial TPR	300	6-1/2" (165)	4-7/16" (112)	Precision Ball	NG-05AMP-125-DL-____
6	1-1/4	QuikStart TPR	300	7-1/2" (191)	4-9/16" (116)	Precision Ball	NG-06QDP-125-DL-____
6	1-1/4	QuikStart TPR	300	7-1/2" (191)	4-9/16" (116)	Plain	NG-06QDO-125-DL-____
6	1-1/4	Anti-Microbial TPR	300	7-1/2" (191)	4-9/16" (116)	Precision Ball	NG-06AMP-125-DL-____



Our Directional Lock casters are designed to lock the swivel but not the wheel allowing you to steer your equipment. The directional lock feature is designed to break free under heavier load when the unit is traversing a corner only to lock back into position when the unit resumes a straight course.

Stems ship with a loose bolt for easier alignment of the directional lock.

Consult factory for 3" diameter model expanding adapter stems.

Specify Expanding Adapter Stem (XR) code, see fittings below for dimensions:

### EXPANDING ADAPTER STEM FITTINGS

See fittings page for more options.

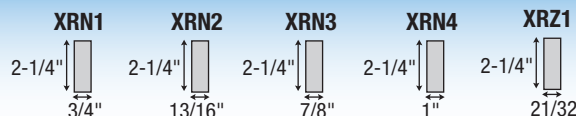

# NEXT GENERATION NYLON (NG)

THREADED STEM MODELS  
FREE SWIVEL • TOTAL LOCK • DIRECTION LOCK

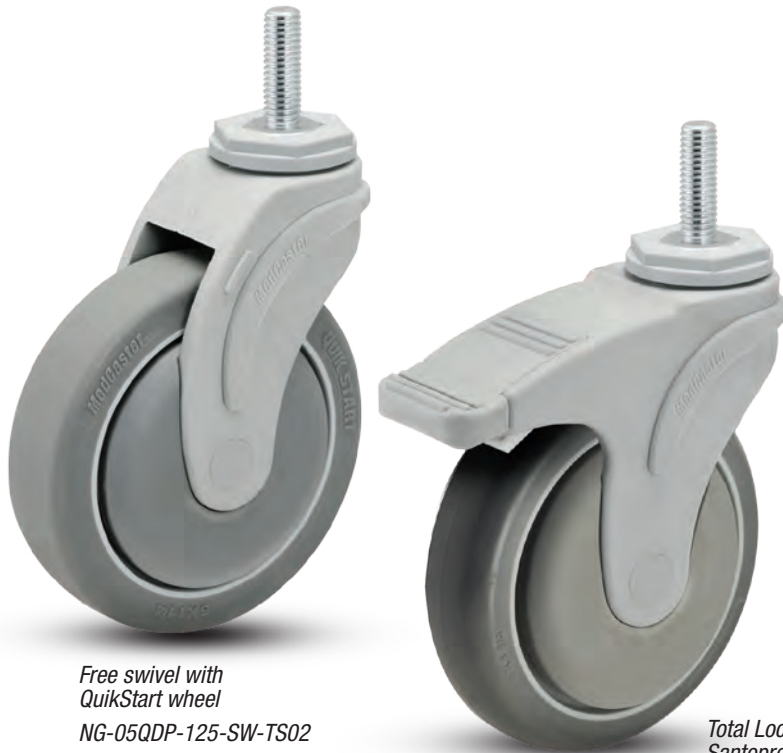

Free swivel with QuikStart wheel  
NG-05QDP-125-SW-TS02

Total Lock with Santoprene wheel  
NG-05RPP-125-TL-TS02

- APPLICATIONS**
- Food Service Equipment
  - Case Carts
  - Utility Carts
  - Medical Equipment
  - Institutional Equipment
  - Hospital Carts
  - Animal Cage Carts

- FEATURES**
- Maintenance free
  - Sealed precision bearing raceway, smooth and quiet
  - **Total Lock Brake** models lock both swivel and wheel
  - Directional lock models lock swivel only (helps with steering)
  - Wheels feature sealed precision ball bearings and full thread guards
  - Resistance to most chemicals
  - Zinc plated top plate
  - Recessed axle with plastic cap covers



Custom Colors Available

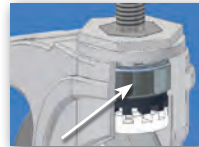

Precision sealed ball bearing raceway design for smooth, quiet maintenance free ride.

Our NG series is made of glass filled nylon for added strength and durability. Precision ball bearings are insert molded into the swivel raceway.

## THREADED STEM MODELS

Precision sealed ball bearing raceway design for smooth, quiet maintenance free ride.

Wheel Diameter (Inches)	Tread Width (Inches)	Wheel Description	Capacity (Lbs)	Load Height Inches (mm)	Swivel Radius Inches (mm)	Wheel Bearing	Model Number
3	1-1/4	QuikStart TPR	200	4-7/32" (107)	2-13/16" (72)	Precision Ball	NG-03QDP-125-SW-_____
3	1-1/4	QuikStart TPR	200	4-7/32" (107)	2-13/16" (72)	Plain	NG-03QDO-125-SW-_____
3	1-1/4	Anti-Microbial TPR	200	4-7/32" (107)	2-13/16" (72)	Precision Ball	NG-03AMP-125-SW-_____
4	1-1/4	QuikStart TPR	275	5-13/32" (137)	3-7/16" (87)	Precision Ball	NG-04QDP-125-SW-_____
4	1-1/4	Anti-Microbial TPR	275	5-13/32" (137)	3-7/16" (87)	Precision Ball	NG-04AMP-125-SW-_____
5	1-1/4	Santoprene	260	6-1/2" (165)	4" (102)	Precision Ball	NG-05RPP-125-SW-_____
5	1-1/4	QuikStart TPR	300	6-1/2" (165)	4" (102)	Precision Ball	NG-05QDP-125-SW-_____
5	1-1/4	Anti-Microbial TPR	300	6-1/2" (165)	4" (102)	Precision Ball	NG-05AMP-125-SW-_____
6	1-1/4	QuikStart TPR	300	7-1/2" (191)	4-9/16" (116)	Precision Ball	NG-06QDP-125-SW-_____
6	1-1/4	QuikStart TPR	300	7-1/2" (191)	4-9/16" (116)	Plain	NG-06QDO-125-SW-_____
6	1-1/4	Anti-Microbial TPR	300	7-1/2" (191)	4-9/16" (116)	Precision Ball	NG-06AMP-125-SW-_____



Note: Antimicrobial casters (AMP) wheels have the the darker grey fork and brighter wheel.

Specify Threaded Stem (TS) code, see fittings below for dimensions:

## THREADED STEM FITTINGS

See fittings page for more options.

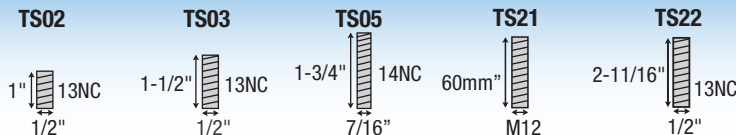



# NEXT GENERATION NYLON (NG)

THREADED STEM MODELS  
FREE SWIVEL • TOTAL LOCK • DIRECTION LOCK

## THREADED STEM TOTAL LOCK MODELS (LOCKS WHEEL AND SWIVEL)

Precision sealed ball bearing raceway design for smooth, quiet maintenance free ride.

Wheel Diameter (Inches)	Tread Width (Inches)	Wheel Description	Capacity (lbs)	Load Height Inches (mm)	Swivel Radius Inches (mm)	Wheel Bearing	Model Number
3	1-1/4	QuikStart TPR	200	4-7/32" (107)	3-3/4" (95)	Precision Ball	NG-03QDP-125-TL-____
3	1-1/4	QuikStart TPR	200	4-7/32" (107)	3-3/4" (95)	Plain	NG-03QDO-125-TL-____
3	1-1/4	Anti-Microbial TPR	200	4-7/32" (107)	3-3/4" (95)	Precision Ball	NG-03AMP-125-TL-____
4	1-1/4	QuikStart TPR	275	5-13/32" (137)	4-7/16" (112)	Precision Ball	NG-04QDP-125-TL-____
4	1-1/4	Anti-Microbial TPR	275	5-13/32" (137)	4-7/16" (112)	Precision Ball	NG-04AMP-125-TL-____
5	1-1/4	Santoprene	260	6-1/2" (165)	4-7/16" (112)	Precision Ball	NG-05RPP-125-TL-____
5	1-1/4	QuikStart TPR	300	6-1/2" (165)	4-7/16" (112)	Precision Ball	NG-05QDP-125-TL-____
5	1-1/4	Anti-Microbial TPR	300	6-1/2" (165)	4-7/16" (112)	Precision Ball	NG-05AMP-125-TL-____
6	1-1/4	QuikStart TPR	300	7-1/2" (191)	4-9/16" (116)	Precision Ball	NG-06QDP-125-TL-____
6	1-1/4	QuikStart TPR	300	7-1/2" (191)	4-9/16" (116)	Plain	NG-06QDO-125-TL-____
6	1-1/4	Anti-Microbial TPR	300	7-1/2" (191)	4-9/16" (116)	Precision Ball	NG-06AMP-125-TL-____



## THREADED STEM DIRECTION LOCK MODELS (LOCKS SWIVEL ONLY)

Precision sealed ball bearing raceway design for smooth, quiet maintenance free ride.

Wheel Diameter (Inches)	Tread Width (Inches)	Wheel Description	Capacity (lbs)	Load Height Inches (mm)	Swivel Radius Inches (mm)	Wheel Bearing	Model Number
3	1-1/4	QuikStart TPR	200	4-7/32" (107)	3-3/4" (95)	Precision Ball	NG-03QDP-125-DL-____
3	1-1/4	QuikStart TPR	200	4-7/32" (107)	3-3/4" (95)	Plain	NG-03QDO-125-DL-____
3	1-1/4	Anti-Microbial TPR	200	4-7/32" (107)	3-3/4" (95)	Precision Ball	NG-03AMP-125-DL-____
4	1-1/4	QuikStart TPR	275	5-13/32" (137)	4-7/16" (112)	Precision Ball	NG-04QDP-125-DL-____
4	1-1/4	Anti-Microbial TPR	275	5-13/32" (137)	4-7/16" (112)	Precision Ball	NG-04AMP-125-DL-____
5	1-1/4	Santoprene	260	6-1/2" (165)	4-7/16" (112)	Precision Ball	NG-05RPP-125-DL-____
5	1-1/4	QuikStart TPR	300	6-1/2" (165)	4-7/16" (112)	Precision Ball	NG-05QDP-125-DL-____
5	1-1/4	Anti-Microbial TPR	300	6-1/2" (165)	4-7/16" (112)	Precision Ball	NG-05AMP-125-DL-____
6	1-1/4	QuikStart TPR	300	7-1/2" (191)	4-9/16" (116)	Precision Ball	NG-06QDP-125-DL-____
6	1-1/4	QuikStart TPR	300	7-1/2" (191)	4-9/16" (116)	Plain	NG-06QDO-125-DL-____
6	1-1/4	Anti-Microbial TPR	300	7-1/2" (191)	4-9/16" (116)	Precision Ball	NG-06AMP-125-DL-____



Our Directional Lock casters are designed to lock the swivel but not the wheel allowing you to steer your equipment. The directional lock feature is designed to break free under heavier load when the unit is traversing a corner only to lock back into position when the unit resumes a straight course.

Stems ship with a loose bolt for easier alignment of the directional lock.

Specify Threaded Stem (TS) code, see fittings below for dimensions:

## THREADED STEM FITTINGS

See fittings page for more options.

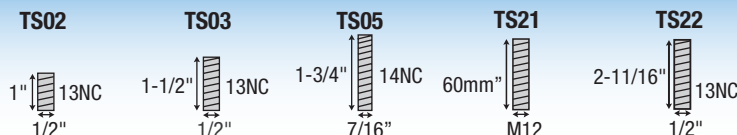

# NEXT GENERATION NYLON (NG)

ROUND/SQUARE STEM MODELS  
FREE SWIVEL • TOTAL LOCK • DIRECTION LOCK



Free swivel with QuikStart wheel  
NG-05QDP-125-SW-RS01



Direction Lock with Santoprene wheel  
NG-05RPP-125-TL-SQ02

- APPLICATIONS**
- Food Service Equipment
  - Case Carts
  - Utility Carts
  - Medical Equipment
  - Institutional Equipment
  - Hospital Carts
  - Animal Cage Carts



Custom Colors Available



Precision sealed ball bearing raceway design for smooth, quiet maintenance free ride.

- FEATURES**
- Maintenance free
  - Sealed precision bearing raceway, smooth and quiet
  - **Total Lock Brake** models lock both swivel and wheel
  - Directional lock models lock swivel only (helps with steering)
  - Wheels feature sealed precision ball bearings and full thread guards
  - Resistance to most chemicals
  - Zinc plated top plate
  - Recessed axle with plastic cap covers

Our NG series is made of glass filled nylon for added strength and durability. Precision ball bearings are insert molded into the swivel raceway.

## ROUND OR SQUARE STEM MODELS

Precision sealed ball bearing raceway design for smooth, quiet maintenance free ride.

Wheel Diameter (Inches)	Tread Width (Inches)	Wheel Description	Capacity (Lbs)	Load Height Inches (mm)	Swivel Radius Inches (mm)	Wheel Bearing	Model Number
3	1-1/4	QuikStart TPR	200	4-7/32" (107)	2-13/16" (72)	Precision Ball	NG-03QDP-125-SW-_____
3	1-1/4	QuikStart TPR	200	4-7/32" (107)	2-13/16" (72)	Plain	NG-03QDO-125-SW-_____
3	1-1/4	Anti-Microbial TPR	200	4-7/32" (107)	2-13/16" (72)	Precision Ball	NG-03AMP-125-SW-_____
4	1-1/4	QuikStart TPR	275	5-13/32" (137)	3-7/16" (87)	Precision Ball	NG-04QDP-125-SW-_____
4	1-1/4	Anti-Microbial TPR	275	5-13/32" (137)	3-7/16" (87)	Precision Ball	NG-04AMP-125-SW-_____
5	1-1/4	Santoprene	260	6-1/2" (165)	4" (102)	Precision Ball	NG-05RPP-125-SW-_____
5	1-1/4	QuikStart TPR	300	6-1/2" (165)	4" (102)	Precision Ball	NG-05QDP-125-SW-_____
5	1-1/4	Anti-Microbial TPR	300	6-1/2" (165)	4" (102)	Precision Ball	NG-05AMP-125-SW-_____
6	1-1/4	QuikStart TPR	300	7-1/2" (191)	4-9/16" (116)	Precision Ball	NG-06QDP-125-SW-_____
6	1-1/4	QuikStart TPR	300	7-1/2" (191)	4-9/16" (116)	Plain	NG-06QDO-125-SW-_____
6	1-1/4	Anti-Microbial TPR	300	7-1/2" (191)	4-9/16" (116)	Precision Ball	NG-06AMP-125-SW-_____



Note: Antimicrobial casters (AMP) wheels have the darker grey fork and brighter wheel.



Rigid model available for 3", 5" and 6" diameter wheels. Change SW to RG.

Specify Round Stem (RS) code, or Square Stem code (SQ) see fittings at left for dimensions.

### ROUND STEM FITTINGS

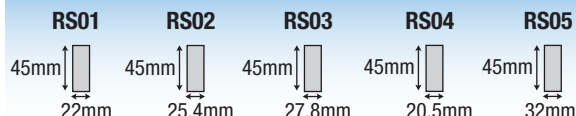

### SQUARE STEM FITTINGS

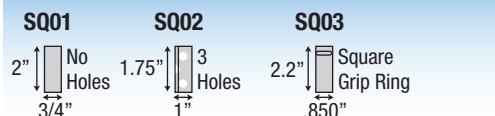

See fittings page for more options.

# NEXT GENERATION NYLON (NG)

ROUND/SQUARE STEM MODELS  
FREE SWIVEL • TOTAL LOCK • DIRECTION LOCK

## ROUND OR SQUARE STEM TOTAL LOCK MODELS

(LOCKS WHEEL AND SWIVEL)

Precision sealed ball bearing raceway design for smooth, quiet maintenance free ride.

Wheel Diameter (Inches)	Tread Width (Inches)	Wheel Description	Capacity (Lbs)	Load Height Inches (mm)	Swivel Radius Inches (mm)	Wheel Bearing	Model Number
3	1-1/4	QuikStart TPR	200	4-7/32" (107)	3-3/4" (95)	Precision Ball	NG-03QDP-125-TL-____
3	1-1/4	QuikStart TPR	200	4-7/32" (107)	3-3/4" (95)	Plain	NG-03QDO-125-TL-____
3	1-1/4	Anti-Microbial TPR	200	4-7/32" (107)	3-3/4" (95)	Precision Ball	NG-03AMP-125-TL-____
4	1-1/4	QuikStart TPR	275	5-13/32" (137)	4-7/16" (112)	Precision Ball	NG-04QDP-125-TL-____
4	1-1/4	Anti-Microbial TPR	275	5-13/32" (137)	4-7/16" (112)	Precision Ball	NG-04AMP-125-TL-____
5	1-1/4	Santoprene	260	6-1/2" (165)	4-7/16" (112)	Precision Ball	NG-05RPP-125-TL-____
5	1-1/4	QuikStart TPR	300	6-1/2" (165)	4-7/16" (112)	Precision Ball	NG-05QDP-125-TL-____
5	1-1/4	Anti-Microbial TPR	300	6-1/2" (165)	4-7/16" (112)	Precision Ball	NG-05AMP-125-TL-____
6	1-1/4	QuikStart TPR	300	7-1/2" (191)	4-9/16" (116)	Precision Ball	NG-06QDP-125-TL-____
6	1-1/4	QuikStart TPR	300	7-1/2" (191)	4-9/16" (116)	Plain	NG-06QDO-125-TL-____
6	1-1/4	Anti-Microbial TPR	300	7-1/2" (191)	4-9/16" (116)	Precision Ball	NG-06AMP-125-TL-____



## ROUND OR SQUARE STEM DIRECTION LOCK MODELS

(LOCKS SWIVEL ONLY)

Precision sealed ball bearing raceway design for smooth, quiet maintenance free ride.

Wheel Diameter (Inches)	Tread Width (Inches)	Wheel Description	Capacity (Lbs)	Load Height Inches (mm)	Swivel Radius Inches (mm)	Wheel Bearing	Model Number
3	1-1/4	QuikStart TPR	200	4-7/32" (107)	3-3/4" (95)	Precision Ball	NG-03QDP-125-DL-____
3	1-1/4	QuikStart TPR	200	4-7/32" (107)	3-3/4" (95)	Plain	NG-03QDO-125-DL-____
3	1-1/4	Anti-Microbial TPR	200	4-7/32" (107)	3-3/4" (95)	Precision Ball	NG-03AMP-125-DL-____
4	1-1/4	QuikStart TPR	275	5-13/32" (137)	4-7/16" (112)	Precision Ball	NG-04QDP-125-DL-____
4	1-1/4	Anti-Microbial TPR	275	5-13/32" (137)	4-7/16" (112)	Precision Ball	NG-04AMP-125-DL-____
5	1-1/4	Santoprene	260	6-1/2" (165)	4-7/16" (112)	Precision Ball	NG-05RPP-125-DL-____
5	1-1/4	QuikStart TPR	300	6-1/2" (165)	4-7/16" (112)	Precision Ball	NG-05QDP-125-DL-____
5	1-1/4	Anti-Microbial TPR	300	6-1/2" (165)	4-7/16" (112)	Precision Ball	NG-05AMP-125-DL-____
6	1-1/4	QuikStart TPR	300	7-1/2" (191)	4-9/16" (116)	Precision Ball	NG-06QDP-125-DL-____
6	1-1/4	QuikStart TPR	300	7-1/2" (191)	4-9/16" (116)	Plain	NG-06QDO-125-DL-____
6	1-1/4	Anti-Microbial TPR	300	7-1/2" (191)	4-9/16" (116)	Precision Ball	NG-06AMP-125-DL-____



Our Directional Lock casters are designed to lock the swivel but not the wheel allowing you to steer your equipment. The directional lock feature is designed to break free under heavier load when the unit is traversing a corner only to lock back into position when the unit resumes a straight course.

Stems ship with a loose bolt for easier alignment of the directional lock.



New rigid brake models now available on 5" models. Change TL to RB

### ROUND STEM FITTINGS

RS01	RS02	RS03	RS04	RS05
45mm 22mm	45mm 25.4mm	45mm 27.8mm	45mm 20.5mm	45mm 32mm

### SQUARE STEM FITTINGS

SQ01	SQ02	SQ03
2" No Holes 3/4"	1.75" 3 Holes 1"	2.2" Square Grip Ring .850"

Specify Round Stem (RS) code, or Square Stem code (SQ) see fittings at left for dimensions.

# NYLON PLUS STAINLESS (NS)

## TOP PLATE MODELS

FREE SWIVEL • TOTAL LOCK • DIRECTION LOCK



- APPLICATIONS**
- Food Service Equipment
  - Case Carts
  - Utility Carts
  - Medical Equipment
  - Institutional Equipment
  - Hospital Carts
  - Animal Cage Carts
  - Pharmaceutical Equipment

304 Stainless steel top plate and components!

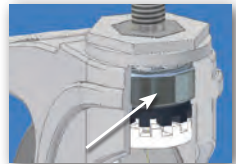

Stainless steel precision sealed ball bearing raceway design for smooth, quiet maintenance free ride.

- FEATURES**
- Sealed stainless steel precision bearing raceway, smooth and quite
  - **Total lock and direction lock** brake models available
  - Wheels feature sealed stainless precision ball bearings and full thread guards
  - Resistant to most chemicals
  - Recessed Stainless axle with plastic cap covers
  - Maintenance free, requires no lubrication for rig or wheel

Our NS Series is similar to NG Series but with the added benefit of 304 stainless components making it excellent for wet environments.

## SWIVEL TOP PLATE MODELS

Precision sealed ball bearing raceway design for smooth, quiet maintenance free ride.

Wheel Diameter (Inches)	Tread Width (Inches)	Wheel Description	Capacity (Lbs)	Load Height Inches (mm)	Swivel Radius Inches (mm)	Wheel Bearing	Model Number
3	1-1/4	QuikStart TPR	200	4-1/4" (108)	2-13/16" (72)	Precision Ball	NS-03QDP-125-SW-TP01
3	1-1/4	QuikStart TPR	200	4-1/4" (108)	2-13/16" (72)	Plain	NS-03QDO-125-SW-TP01
3	1-1/4	Anti-Microbial TPR	200	4-1/4" (108)	2-13/16" (72)	Precision Ball	NS-03AMP-125-SW-TP01
4	1-1/4	QuikStart TPR	275	5-3/4" (146)	3-7/16" (87)	Precision Ball	NS-04QDP-125-SW-TP01
4	1-1/4	Anti-Microbial TPR	275	5-3/4" (146)	3-7/16" (87)	Precision Ball	NS-04AMP-125-SW-TP01
5	1-1/4	QuikStart TPR	300	6-7/8" (174)	4" (102)	Precision Ball	NS-05QDP-125-SW-TP01
5	1-1/4	Anti-Microbial TPR	300	6-7/8" (174)	4" (102)	Precision Ball	NS-05AMP-125-SW-TP01
6	1-1/4	QuikStart TPR	300	7-11/16" (195)	4-9/16" (116)	Precision Ball	NS-06QDP-125-SW-TP01
6	1-1/4	QuikStart TPR	300	7-11/16" (195)	4-9/16" (116)	Plain	NS-06QDO-125-SW-TP01
6	1-1/4	Anti-Microbial TPR	300	7-11/16" (195)	4-9/16" (116)	Precision Ball	NS-06AMP-125-SW-TP01



Rigid model available for 3", 5" and 6" diameter wheels. Change SW to RG.

## TOP PLATE FITTING

Swivel Top Plate Pattern

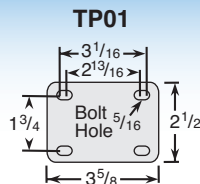

Custom Colors Available

# NYLON PLUS STAINLESS (NS)

## TOP PLATE MODELS

FREE SWIVEL • TOTAL LOCK • DIRECTION LOCK

### SWIVEL TOP PLATE TOTAL LOCK MODELS

(LOCKS WHEEL AND SWIVEL)

Precision sealed ball bearing raceway design for smooth, quiet maintenance free ride.

Wheel Diameter (Inches)	Tread Width (Inches)	Wheel Description	Capacity (Lbs)	Load Height Inches (mm)	Swivel Radius Inches (mm)	Wheel Bearing	Model Number
3	1-1/4	QuikStart TPR	200	4-1/4" (108)	3-3/4" (95)	Precision Ball	NS-03QDP-125-TL-TP01
3	1-1/4	QuikStart TPR	200	4-1/4" (108)	3-3/4" (95)	Plain	NS-03QDO-125-TL-TP01
3	1-1/4	Anti-Microbial TPR	200	4-1/4" (108)	3-3/4" (95)	Precision Ball	NS-03AMP-125-TL-TP01
4	1-1/4	QuikStart TPR	275	5-3/4" (146)	4-7/16" (112)	Precision Ball	NS-04QDP-125-TL-TP01
4	1-1/4	Anti-Microbial TPR	275	5-3/4" (146)	4-7/16" (112)	Precision Ball	NS-04AMP-125-TL-TP01
5	1-1/4	QuikStart TPR	300	6-7/8" (174)	4-7/16" (112)	Precision Ball	NS-05QDP-125-TL-TP01
5	1-1/4	Anti-Microbial TPR	300	6-7/8" (174)	4-7/16" (112)	Precision Ball	NS-05AMP-125-TL-TP01
6	1-1/4	QuikStart TPR	300	7-11/16" (195)	4-9/16" (116)	Precision Ball	NS-06QDP-125-TL-TP01
6	1-1/4	QuikStart TPR	300	7-11/16" (195)	4-9/16" (116)	Plain	NS-06QDO-125-TL-TP01
6	1-1/4	Anti-Microbial TPR	300	7-11/16" (195)	4-9/16" (116)	Precision Ball	NS-06AMP-125-TL-TP01



### SWIVEL TOP PLATE DIRECTION LOCK MODELS

(LOCKS SWIVEL ONLY)

Precision sealed ball bearing raceway design for smooth, quiet maintenance free ride.

Wheel Diameter (Inches)	Tread Width (Inches)	Wheel Description	Capacity (Lbs)	Load Height Inches (mm)	Swivel Radius Inches (mm)	Wheel Bearing	Model Number
3	1-1/4	QuikStart TPR	200	4-1/4" (108)	3-3/4" (95)	Precision Ball	NS-03QDP-125-DL-TP01
3	1-1/4	QuikStart TPR	200	4-1/4" (108)	3-3/4" (95)	Plain	NS-03QDO-125-DL-TP01
3	1-1/4	Anti-Microbial TPR	200	4-1/4" (108)	3-3/4" (95)	Precision Ball	NS-03AMP-125-DL-TP01
4	1-1/4	QuikStart TPR	275	5-3/4" (146)	4-7/16" (112)	Precision Ball	NS-04QDP-125-DL-TP01
4	1-1/4	Anti-Microbial TPR	275	5-3/4" (146)	4-7/16" (112)	Precision Ball	NS-04AMP-125-DL-TP01
5	1-1/4	QuikStart TPR	300	6-7/8" (174)	4-7/16" (112)	Precision Ball	NS-05QDP-125-DL-TP01
5	1-1/4	Anti-Microbial TPR	300	6-7/8" (174)	4-7/16" (112)	Precision Ball	NS-05AMP-125-DL-TP01
6	1-1/4	QuikStart TPR	300	7-11/16" (195)	4-9/16" (116)	Precision Ball	NS-06QDP-125-DL-TP01
6	1-1/4	QuikStart TPR	300	7-11/16" (195)	4-9/16" (116)	Plain	NS-06QDO-125-DL-TP01
6	1-1/4	Anti-Microbial TPR	300	7-11/16" (195)	4-9/16" (116)	Precision Ball	NS-06AMP-125-DL-TP01



Our Directional Lock casters are designed to lock the swivel but not the wheel allowing you to steer your equipment. The directional lock feature is designed to break free under heavier load when the unit is traversing a corner only to lock back into position when the unit resumes a straight course.



New rigid brake models now available on 5" models. Change TL to RB

### TOP PLATE FITTING

Swivel Top Plate Pattern

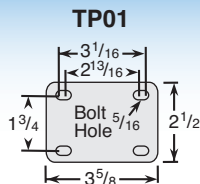

# NYLON PLUS STAINLESS (NS)

HOLLOW KINGPIN MODELS  
FREE SWIVEL • TOTAL LOCK • DIRECTION LOCK



- APPLICATIONS**
- Food Service Equipment
  - Case Carts
  - Utility Carts
  - Medical Equipment
  - Institutional Equipment
  - Hospital Carts
  - Animal Cage Carts
  - Pharmaceutical Equipment

304 Stainless steel components!

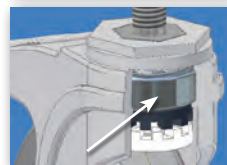

Stainless steel precision sealed ball bearing raceway design for smooth, quiet maintenance free ride.

- FEATURES**
- Sealed stainless steel precision bearing raceway, smooth and quite
  - **Total lock and direction lock brake models available**
  - Wheels feature sealed stainless precision ball bearings and full thread guards
  - Resistant to most chemicals
  - Recessed Stainless axle with plastic cap covers
  - Maintenance free, requires no lubrication for rig or wheel

Our NS Series is similar to NG Series but with the added benefit of 304 stainless components making it excellent for wet environments.

## HOLLOW KINGPIN MODELS

Precision sealed ball bearing raceway design for smooth, quiet maintenance free ride.

Wheel Diameter (Inches)	Tread Width (Inches)	Wheel Description	Capacity (Lbs)	Load Height Inches (mm)	Swivel Radius Inches (mm)	Wheel Bearing	Model Number
3	1-1/4	QuikStart TPR	200	4-7/32" (107)	2-13/16" (72)	Precision Ball	NS-03QDP-125-SW-HKU4
3	1-1/4	QuikStart TPR	200	4-7/32" (107)	2-13/16" (72)	Plain	NS-03QDO-125-SW-HKU4
3	1-1/4	Anti-Microbial TPR	200	4-7/32" (107)	2-13/16" (72)	Precision Ball	NS-03AMP-125-SW-HKU4
4	1-1/4	QuikStart TPR	275	5-13/32" (137)	3-7/16" (87)	Precision Ball	NS-04QDP-125-SW-HKU1
4	1-1/4	Anti-Microbial TPR	275	5-13/32" (137)	3-7/16" (87)	Precision Ball	NS-04AMP-125-SW-HKU1
5	1-1/4	QuikStart TPR	300	6-1/2" (165)	4" (102)	Precision Ball	NS-05QDP-125-SW-HKU1
5	1-1/4	Anti-Microbial TPR	300	6-1/2" (165)	4" (102)	Precision Ball	NS-05AMP-125-SW-HKU1
6	1-1/4	QuikStart TPR	300	7-1/2" (191)	4-9/16" (116)	Precision Ball	NS-06QDP-125-SW-HKU1
6	1-1/4	QuikStart TPR	300	7-1/2" (191)	4-9/16" (116)	Plain	NS-06QDO-125-SW-HKU1
6	1-1/4	Anti-Microbial TPR	300	7-1/2" (191)	4-9/16" (116)	Precision Ball	NS-06AMP-125-SW-HKU1



Rigid model available for 3", 5" and 6" diameter wheels. Change SW to RG.

## HOLLOW KINGPIN

Caster is **provided unassembled** to make it easy to add your choice of fitting. If you would like these assembled change **HKU4** to **HKO4** on 3" diameter models. Change **HKU1** to **HKO1** on 4" to 6" diameter models. 3/8" I.D. on 3" diam. models; 1/2" I.D. on 4", 5", & 6" diam. models.



Custom Colors Available

# NYLON PLUS STAINLESS (NS)

HOLLOW KINGPIN MODELS  
FREE SWIVEL • TOTAL LOCK • DIRECTION LOCK

## HOLLOW KINGPIN TOTAL LOCK MODELS

(LOCKS WHEEL AND SWIVEL)

Precision sealed ball bearing raceway design for smooth, quiet maintenance free ride.

Wheel Diameter (Inches)	Tread Width (Inches)	Wheel Description	Capacity (Lbs)	Load Height Inches (mm)	Swivel Radius Inches (mm)	Wheel Bearing	Model Number
3	1-1/4	QuikStart TPR	200	4-7/32" (107)	3-3/4" (95)	Precision Ball	NS-03QDP-125-TL-HKU4
3	1-1/4	QuikStart TPR	200	4-7/32" (107)	3-3/4" (95)	Plain	NS-03QDO-125-TL-HKU4
3	1-1/4	Anti-Microbial TPR	200	4-7/32" (107)	3-3/4" (95)	Precision Ball	NS-03AMP-125-TL-HKU4
4	1-1/4	QuikStart TPR	275	5-13/32" (137)	4-7/16" (112)	Precision Ball	NS-04QDP-125-TL-HKU1
4	1-1/4	Anti-Microbial TPR	275	5-13/32" (137)	4-7/16" (112)	Precision Ball	NS-04AMP-125-TL-HKU1
5	1-1/4	QuikStart TPR	300	6-1/2" (165)	4-7/16" (112)	Precision Ball	NS-05QDP-125-TL-HKU1
5	1-1/4	Anti-Microbial TPR	300	6-1/2" (165)	4-7/16" (112)	Precision Ball	NS-05AMP-125-TL-HKU1
6	1-1/4	QuikStart TPR	300	7-1/2" (191)	4-9/16" (116)	Precision Ball	NS-06QDP-125-TL-HKU1
6	1-1/4	QuikStart TPR	300	7-1/2" (191)	4-9/16" (116)	Plain	NS-06QDO-125-TL-HKU1
6	1-1/4	Anti-Microbial TPR	300	7-1/2" (191)	4-9/16" (116)	Precision Ball	NS-06AMP-125-TL-HKU1



## HOLLOW KINGPIN DIRECTION LOCK MODELS

(LOCKS SWIVEL ONLY)

Precision sealed ball bearing raceway design for smooth, quiet maintenance free ride.

Wheel Diameter (Inches)	Tread Width (Inches)	Wheel Description	Capacity (Lbs)	Load Height Inches (mm)	Swivel Radius Inches (mm)	Wheel Bearing	Model Number
3	1-1/4	QuikStart TPR	200	4-7/32" (107)	3-3/4" (95)	Precision Ball	NS-03QDP-125-DL-HKU4
3	1-1/4	QuikStart TPR	200	4-7/32" (107)	3-3/4" (95)	Plain	NS-03QDO-125-DL-HKU4
3	1-1/4	Anti-Microbial TPR	200	4-7/32" (107)	3-3/4" (95)	Precision Ball	NS-03AMP-125-DL-HKU4
4	1-1/4	QuikStart TPR	275	5-13/32" (137)	4-7/16" (112)	Precision Ball	NS-04QDP-125-DL-HKU1
4	1-1/4	Anti-Microbial TPR	275	5-13/32" (137)	4-7/16" (112)	Precision Ball	NS-04AMP-125-DL-HKU1
5	1-1/4	QuikStart TPR	300	6-1/2" (165)	4-7/16" (112)	Precision Ball	NS-05QDP-125-DL-HKU1
5	1-1/4	Anti-Microbial TPR	300	6-1/2" (165)	4-7/16" (112)	Precision Ball	NS-05AMP-125-DL-HKU1
6	1-1/4	QuikStart TPR	300	7-1/2" (191)	4-9/16" (116)	Precision Ball	NS-06QDP-125-DL-HKU1
6	1-1/4	QuikStart TPR	300	7-1/2" (191)	4-9/16" (116)	Plain	NS-06QDO-125-DL-HKU1
6	1-1/4	Anti-Microbial TPR	300	7-1/2" (191)	4-9/16" (116)	Precision Ball	NS-06AMP-125-DL-HKU1



Our Directional Lock casters are designed to lock the swivel but not the wheel allowing you to steer your equipment. The directional lock feature is designed to break free under heavier load when the unit is traversing a corner only to lock back into position when the unit resumes a straight course.



New rigid brake models now available on 5" models. Change TL to RB

## HOLLOW KINGPIN

Caster is **provided unassembled** to make it easy to add your choice of fitting. If you would like these assembled change **HKU4** to **HK04** on 3" diameter models. Change **HKU1** to **HK01** on 4" to 6" diameter models. 3/8" I.D. on 3" diam. models; 1/2" I.D. on 4", 5", & 6" diam. models.

# NYLON PLUS STAINLESS (NS)

EXPANDING ADAPTER STEM MODELS  
FREE SWIVEL • TOTAL LOCK • DIRECTION LOCK



- APPLIC**
- Food Service Equipment
  - Case Carts
  - Utility Carts
  - Medical Equipment
  - Institutional Equipment
  - Hospital Carts
  - Animal Cage Carts
  - Pharmaceutical Equipment

- FEATURES**
- Sealed stainless steel precision bearing raceway, smooth and quite
  - **Total lock and direction lock** brake models available
  - Wheels feature sealed stainless precision ball bearings and full thread guards
  - Resistant to most chemicals
  - Recessed Stainless axle with plastic cap covers
  - Maintenance free, requires no lubrication for rig or wheel

304 Stainless steel components!

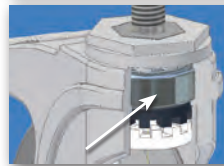

Stainless steel precision sealed ball bearing raceway design for smooth, quiet maintenance free ride.

Our NS Series is similar to NG Series but with the added benefit of 304 stainless components making it excellent for wet environments.

## EXPANDING ADAPTER STEM MODELS

Precision sealed ball bearing raceway design for smooth, quiet maintenance free ride.

Wheel Diameter (Inches)	Tread Width (Inches)	Wheel Description	Capacity (Lbs)	Load Height Inches (mm)	Swivel Radius Inches (mm)	Wheel Bearing	Model Number
3	1-1/4	QuikStart TPR	200	4-7/32" (107)	2-13/16" (72)	Precision Ball	NS-03QDP-125-SW-_____
3	1-1/4	QuikStart TPR	200	4-7/32" (107)	2-13/16" (72)	Plain	NS-03QDO-125-SW-_____
3	1-1/4	Anti-Microbial TPR	200	4-7/32" (107)	2-13/16" (72)	Precision Ball	NS-03AMP-125-SW-_____
4	1-1/4	QuikStart TPR	275	5-13/32" (137)	3-7/16" (87)	Precision Ball	NS-04QDP-125-SW-_____
4	1-1/4	Anti-Microbial TPR	275	5-13/32" (137)	3-7/16" (87)	Precision Ball	NS-04AMP-125-SW-_____
5	1-1/4	QuikStart TPR	300	6-1/2" (165)	4" (102)	Precision Ball	NS-05QDP-125-SW-_____
5	1-1/4	Anti-Microbial TPR	300	6-1/2" (165)	4" (102)	Precision Ball	NS-05AMP-125-SW-_____
6	1-1/4	QuikStart TPR	300	7-1/2" (191)	4-9/16" (116)	Precision Ball	NS-06QDP-125-SW-_____
6	1-1/4	QuikStart TPR	300	7-1/2" (191)	4-9/16" (116)	Plain	NS-06QDO-125-SW-_____
6	1-1/4	Anti-Microbial TPR	300	7-1/2" (191)	4-9/16" (116)	Precision Ball	NS-06AMP-125-SW-_____



Consult factory for 3" diameter model expanding adapter stems.

**Note:** Expanding adapter components are not Stainless steel.

## EXPANDING ADAPTER STEM FITTINGS

See fittings page for more options.

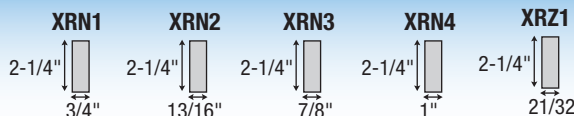

Specify Expanding Adapter Stem Round Nylon (XRN) code, Round Zamac (XRZ). see fittings at left for dimensions:



Custom Colors Available



# NYLON PLUS STAINLESS (NS)

EXPANDING ADAPTER STEM MODELS  
FREE SWIVEL • TOTAL LOCK • DIRECTION LOCK

## EXPANDING ADAPTER STEM TOTAL LOCK MODELS (LOCKS WHEEL AND SWIVEL)

Precision sealed ball bearing raceway design for smooth, quiet maintenance free ride.

Wheel Diameter (Inches)	Tread Width (Inches)	Wheel Description	Capacity (Lbs)	Load Height Inches (mm)	Swivel Radius Inches (mm)	Wheel Bearing	Model Number
3	1-1/4	QuikStart TPR	200	4-7/32" (107)	3-3/4" (95)	Precision Ball	NS-03QDP-125-TL-____
3	1-1/4	QuikStart TPR	200	4-7/32" (107)	3-3/4" (95)	Plain	NS-03QDO-125-TL-____
3	1-1/4	Anti-Microbial TPR	200	4-7/32" (107)	3-3/4" (95)	Precision Ball	NS-03AMP-125-TL-____
4	1-1/4	QuikStart TPR	275	5-13/32" (137)	4-7/16" (112)	Precision Ball	NS-04QDP-125-TL-____
4	1-1/4	Anti-Microbial TPR	275	5-13/32" (137)	4-7/16" (112)	Precision Ball	NS-04AMP-125-TL-____
5	1-1/4	QuikStart TPR	300	6-1/2" (165)	4-7/16" (112)	Precision Ball	NS-05QDP-125-TL-____
5	1-1/4	Anti-Microbial TPR	300	6-1/2" (165)	4-7/16" (112)	Precision Ball	NS-05AMP-125-TL-____
6	1-1/4	QuikStart TPR	300	7-1/2" (191)	4-9/16" (116)	Precision Ball	NS-06QDP-125-TL-____
6	1-1/4	QuikStart TPR	300	7-1/2" (191)	4-9/16" (116)	Plain	NS-06QDO-125-TL-____
6	1-1/4	Anti-Microbial TPR	300	7-1/2" (191)	4-9/16" (116)	Precision Ball	NS-06AMP-125-TL-____



## EXPANDING ADAPTER STEM DIRECTION LOCK MODELS (LOCKS SWIVEL ONLY)

Precision sealed ball bearing raceway design for smooth, quiet maintenance free ride.

Wheel Diameter (Inches)	Tread Width (Inches)	Wheel Description	Capacity (Lbs)	Load Height Inches (mm)	Swivel Radius Inches (mm)	Wheel Bearing	Model Number
3	1-1/4	QuikStart TPR	200	4-7/32" (107)	3-3/4" (95)	Precision Ball	NS-03QDP-125-DL-____
3	1-1/4	QuikStart TPR	200	4-7/32" (107)	3-3/4" (95)	Plain	NS-03QDO-125-DL-____
3	1-1/4	Anti-Microbial TPR	200	4-7/32" (107)	3-3/4" (95)	Precision Ball	NS-03AMP-125-DL-____
4	1-1/4	QuikStart TPR	275	5-13/32" (137)	4-7/16" (112)	Precision Ball	NS-04QDP-125-DL-____
4	1-1/4	Anti-Microbial TPR	275	5-13/32" (137)	4-7/16" (112)	Precision Ball	NS-04AMP-125-DL-____
5	1-1/4	QuikStart TPR	300	6-1/2" (165)	4-7/16" (112)	Precision Ball	NS-05QDP-125-DL-____
5	1-1/4	Anti-Microbial TPR	300	6-1/2" (165)	4-7/16" (112)	Precision Ball	NS-05AMP-125-DL-____
6	1-1/4	QuikStart TPR	300	7-1/2" (191)	4-9/16" (116)	Precision Ball	NS-06QDP-125-DL-____
6	1-1/4	QuikStart TPR	300	7-1/2" (191)	4-9/16" (116)	Plain	NS-06QDO-125-DL-____
6	1-1/4	Anti-Microbial TPR	300	7-1/2" (191)	4-9/16" (116)	Precision Ball	NS-06AMP-125-DL-____



Our Directional Lock casters are designed to lock the swivel but not the wheel allowing you to steer your equipment. The directional lock feature is designed to break free under heavier load when the unit is traversing a corner only to lock back into position when the unit resumes a straight course.

Consult factory for 3" diameter model expanding adapter stems.

**Note:** Expanding adapter components are not Stainless steel.

### EXPANDING ADAPTER STEM FITTINGS

See fittings page for more options.

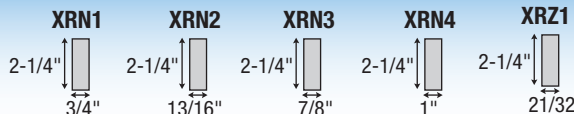

Specify Expanding Adapter Stem Round Nylon (XRN) code, Round Zamac (XRZ). see fittings at left for dimensions:

# NYLON PLUS STAINLESS (NS)

THREADED STEM MODELS  
FREE SWIVEL • TOTAL LOCK • DIRECTION LOCK



- APPLICATIONS**
- Food Service Equipment
  - Case Carts
  - Utility Carts
  - Medical Equipment
  - Institutional Equipment
  - Hospital Carts
  - Animal Cage Carts
  - Pharmaceutical Equipment

304 Stainless steel components!

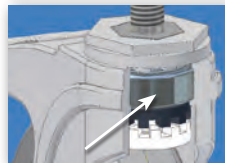

Stainless steel precision sealed ball bearing raceway design for smooth, quiet maintenance free ride.

- FEATURES**
- Sealed stainless steel precision bearing raceway, smooth and quite
  - **Total lock and direction lock brake models available**
  - Wheels feature sealed stainless precision ball bearings and full thread guards
  - Resistant to most chemicals
  - Recessed Stainless axle with plastic cap covers
  - Maintenance free, requires no lubrication for rig or wheel

Our NS Series is similar to NG Series but with the added benefit of 304 stainless components making it excellent for wet environments.

## THREADED STEM MODELS

Precision sealed ball bearing raceway design for smooth, quiet maintenance free ride.

Wheel Diameter (Inches)	Tread Width (Inches)	Wheel Description	Capacity (Lbs)	Load Height Inches (mm)	Swivel Radius Inches (mm)	Wheel Bearing	Model Number
3	1-1/4	QuikStart TPR	200	4-7/32" (107)	2-13/16" (72)	Precision Ball	NS-03QDP-125-SW-_____
3	1-1/4	QuikStart TPR	200	4-7/32" (107)	2-13/16" (72)	Plain	NS-03QDO-125-SW-_____
3	1-1/4	Anti-Microbial TPR	200	4-7/32" (107)	2-13/16" (72)	Precision Ball	NS-03AMP-125-SW-_____
4	1-1/4	QuikStart TPR	275	5-13/32" (137)	3-7/16" (87)	Precision Ball	NS-04QDP-125-SW-_____
4	1-1/4	Anti-Microbial TPR	275	5-13/32" (137)	3-7/16" (87)	Precision Ball	NS-04AMP-125-SW-_____
5	1-1/4	QuikStart TPR	300	6-1/2" (165)	4" (102)	Precision Ball	NS-05QDP-125-SW-_____
5	1-1/4	Anti-Microbial TPR	300	6-1/2" (165)	4" (102)	Precision Ball	NS-05AMP-125-SW-_____
6	1-1/4	QuikStart TPR	300	7-1/2" (191)	4-9/16" (116)	Precision Ball	NS-06QDP-125-SW-_____
6	1-1/4	QuikStart TPR	300	7-1/2" (191)	4-9/16" (116)	Plain	NS-06QDO-125-SW-_____
6	1-1/4	Anti-Microbial TPR	300	7-1/2" (191)	4-9/16" (116)	Precision Ball	NS-06AMP-125-SW-_____



## THREADED STEM FITTINGS

Stainless steel. See fittings page for more options.

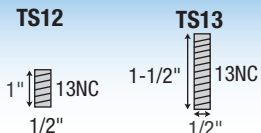

Specify Threaded Stem (TS) code, see fittings below for dimensions:



Custom Colors Available

# NYLON PLUS STAINLESS (NS)

THREADED STEM MODELS  
FREE SWIVEL • TOTAL LOCK • DIRECTION LOCK

## THREADED STEM TOTAL LOCK MODELS

(LOCKS WHEEL AND SWIVEL)

Precision sealed ball bearing raceway design for smooth, quiet maintenance free ride.

Wheel Diameter (Inches)	Tread Width (Inches)	Wheel Description	Capacity (Lbs)	Load Height Inches (mm)	Swivel Radius Inches (mm)	Wheel Bearing	Model Number
3	1-1/4	QuikStart TPR	200	4-7/32" (107)	3-3/4" (95)	Precision Ball	NS-03QDP-125-TL-___
3	1-1/4	QuikStart TPR	200	4-7/32" (107)	3-3/4" (95)	Plain	NS-03QDO-125-TL-___
3	1-1/4	Anti-Microbial TPR	200	4-7/32" (107)	3-3/4" (95)	Precision Ball	NS-03AMP-125-TL-___
4	1-1/4	QuikStart TPR	275	5-13/32" (137)	4-7/16" (112)	Precision Ball	NS-04QDP-125-TL-___
4	1-1/4	Anti-Microbial TPR	275	5-13/32" (137)	4-7/16" (112)	Precision Ball	NS-04AMP-125-TL-___
5	1-1/4	QuikStart TPR	300	6-1/2" (165)	4-7/16" (112)	Precision Ball	NS-05QDP-125-TL-___
5	1-1/4	Anti-Microbial TPR	300	6-1/2" (165)	4-7/16" (112)	Precision Ball	NS-05AMP-125-TL-___
6	1-1/4	QuikStart TPR	300	7-1/2" (191)	4-9/16" (116)	Precision Ball	NS-06QDP-125-TL-___
6	1-1/4	QuikStart TPR	300	7-1/2" (191)	4-9/16" (116)	Plain	NS-06QDO-125-TL-___
6	1-1/4	Anti-Microbial TPR	300	7-1/2" (191)	4-9/16" (116)	Precision Ball	NS-06AMP-125-TL-___



## THREADED STEM DIRECTION LOCK MODELS

(LOCKS SWIVEL ONLY)

Precision sealed ball bearing raceway design for smooth, quiet maintenance free ride.

Wheel Diameter (Inches)	Tread Width (Inches)	Wheel Description	Capacity (Lbs)	Load Height Inches (mm)	Swivel Radius Inches (mm)	Wheel Bearing	Model Number
3	1-1/4	QuikStart TPR	200	4-7/32" (107)	3-3/4" (95)	Precision Ball	NS-03QDP-125-DL-___
3	1-1/4	QuikStart TPR	200	4-7/32" (107)	3-3/4" (95)	Plain	NS-03QDO-125-DL-___
3	1-1/4	Anti-Microbial TPR	200	4-7/32" (107)	3-3/4" (95)	Precision Ball	NS-03AMP-125-DL-___
4	1-1/4	QuikStart TPR	275	5-13/32" (137)	4-7/16" (112)	Precision Ball	NS-04QDP-125-DL-___
4	1-1/4	Anti-Microbial TPR	275	5-13/32" (137)	4-7/16" (112)	Precision Ball	NS-04AMP-125-DL-___
5	1-1/4	QuikStart TPR	300	6-1/2" (165)	4-7/16" (112)	Precision Ball	NS-05QDP-125-DL-___
5	1-1/4	Anti-Microbial TPR	300	6-1/2" (165)	4-7/16" (112)	Precision Ball	NS-05AMP-125-DL-___
6	1-1/4	QuikStart TPR	300	7-1/2" (191)	4-9/16" (116)	Precision Ball	NS-06QDP-125-DL-___
6	1-1/4	QuikStart TPR	300	7-1/2" (191)	4-9/16" (116)	Plain	NS-06QDO-125-DL-___
6	1-1/4	Anti-Microbial TPR	300	7-1/2" (191)	4-9/16" (116)	Precision Ball	NS-06AMP-125-DL-___



Our Directional Lock casters are designed to lock the swivel but not the wheel allowing you to steer your equipment. The directional lock feature is designed to break free under heavier load when the unit is traversing a corner only to lock back into position when the unit resumes a straight course.

Stems ship with a loose bolt for easier alignment of the directional lock.

Specify Threaded Stem (TS) code, see fittings below for dimensions:

### THREADED STEM FITTINGS

Stainless steel.  
See fittings page for more options.

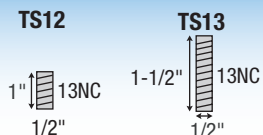

# NON-MAGNETIC NYLON (NM)

## TOP PLATE MODELS

FREE SWIVEL • TOTAL LOCK • DIRECTION LOCK



### APPLICATIONS

- MRI conditional equipment
- Hospital Carts
- Utility Carts
- Medical Equipment
- Electronic Equipment

### FEATURES

- Designed for use in areas where casters need to have reduced magnetic properties
- Maintenance free
- Sealed precision bearing raceway, smooth and quiet
- **Total Lock Brake** models lock both swivel and wheel
- Directional lock models lock swivel only (helps with steering)
- Wheels feature Delrin bearings
- Resistance to most chemicals
- Top plate made of 316SS Stainless steel
- Recessed axle with plastic cap covers



Custom Colors Available

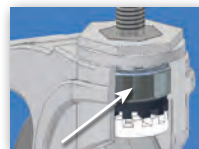

316S stainless steel precision sealed ball bearing raceway design for smooth, quiet maintenance free ride.

Nylon and 316S stainless steel construction allows these casters to have a reduced magnetism.

## SWIVEL TOP PLATE MODELS

Precision sealed ball bearing raceway design for smooth, quiet maintenance free ride.

Wheel Diameter (Inches)	Tread Width (Inches)	Wheel Description	Capacity (lbs)	Load Height Inches (mm)	Swivel Radius Inches (mm)	Wheel Bearing	Model Number
3	1-1/4	QuikStart TPR	100	4-1/4" (108)	2-13/16" (72)	Delrin	NM-03QDO-125-SW-TPS1
4	1-1/4	QuikStart TPR	150	5-3/4" (146)	3-7/16" (87)	Delrin	NM-04QDO-125-SW-TPS1
5	1-1/4	QuikStart TPR	200	6-7/8" (174)	4" (102)	Delrin	NM-05QDO-125-SW-TPS1



## SWIVEL TOP PLATE TOTAL LOCK MODELS

(LOCKS WHEEL AND SWIVEL)

3	1-1/4	QuikStart TPR	100	4-1/4" (108)	3-3/4" (95)	Delrin	NM-03QDO-125-TL-TPS1
4	1-1/4	QuikStart TPR	150	5-3/4" (146)	4-7/16" (112)	Delrin	NM-04QDO-125-TL-TPS1
5	1-1/4	QuikStart TPR	200	6-7/8" (174)	4-7/16" (112)	Delrin	NM-05QDO-125-TL-TPS1



## TOP PLATE FITTING

Swivel Top Plate Pattern

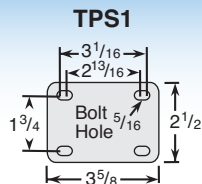

# NON-MAGNETIC NYLON (NM)

THREADED STEM MODELS  
FREE SWIVEL • TOTAL LOCK • DIRECTION LOCK



**APPLICATIONS**

- MRI conditional equipment
- Hospital Carts
- Utility Carts
- Medical Equipment
- Electronic Equipment

**FEATURES**

- Designed for use in areas where casters need to have reduced magnetic properties
- Maintenance free
- Sealed precision bearing raceway, smooth and quiet
- **Total Lock Brake** models lock both swivel and wheel
- Directional lock models lock swivel only (helps with steering)
- Wheels feature Delrin bearings
- Resistance to most chemicals
- Recessed axle with plastic cap covers



Custom Colors Available

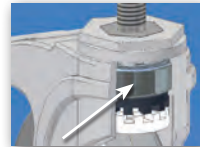

316S stainless steel precision sealed ball bearing raceway design for smooth, quiet maintenance free ride.

Nylon and 316S stainless steel construction allows these casters to have a reduced magnetism.

## THREADED STEM MODELS

Precision sealed ball bearing raceway design for smooth, quiet maintenance free ride.

Wheel Diameter (Inches)	Tread Width (Inches)	Wheel Description	Capacity (lbs)	Load Height Inches (mm)	Swivel Radius Inches (mm)	Wheel Bearing	Model Number
3	1-1/4	QuikStart TPR	100	4-7/32" (107)	2-13/16" (72)	Delrin	NM-03QDO-125-SW-TSS2
4	1-1/4	QuikStart TPR	150	5-13/32" (137)	3-7/16" (87)	Delrin	NM-04QDO-125-SW-TSS2
5	1-1/4	QuikStart TPR	200	6-1/2" (165)	4" (102)	Delrin	NM-05QDO-125-SW-TSS2



## THREADED STEM TOTAL LOCK MODELS

(LOCKS WHEEL AND SWIVEL)

3	1-1/4	QuikStart TPR	100	4-7/32" (107)	3-3/4" (95)	Delrin	NM-03QDO-125-TL-TSS2
4	1-1/4	QuikStart TPR	150	5-13/32" (137)	4-7/16" (112)	Delrin	NM-04QDO-125-TL-TSS2
5	1-1/4	QuikStart TPR	200	6-1/2" (165)	4-7/16" (112)	Delrin	NM-05QDO-125-TL-TSS2



## THREADED STEM FITTINGS

See fittings page for more options.

TSS2



TSS2 stems require special order from the factory and increase lead times.

# MARQUEE (MP)

## TOP PLATE MODELS

FREE SWIVEL • TOTAL LOCK • DIRECTION LOCK

**IMPROVED**



- APPLICATIONS**
- Food Service Equipment
  - Case Carts
  - Utility Carts
  - Medical Equipment
  - Institutional Equipment
  - Hospital Carts
  - Animal Cage Carts
  - Pharmaceutical Equipment

- FEATURES**
- Glass filled nylon body
  - New precision ball bearing raceway
  - **Total lock and direction lock brake models available**
  - Resistant to water and most chemicals
  - Precision bearing in wheel
  - Zinc plated top plate
  - Riveted axle
  - Standard color is light gray with white strip and white wheel core

Our MP Series features attractive two-tone accents.



Custom colors available. Consult factory for quantities.

## SWIVEL TOP PLATE MODELS

Wheel Diameter (Inches)	Tread Width (Inches)	Wheel Description	Capacity (Lbs)	Load Height Inches (mm)	Swivel Radius Inches (mm)	Wheel Bearing	Model Number
5	1-1/4	TPR Flat	250	6-3/4" (171)	4" (100)	Precision Ball	MP-05TPP-125-SW-TP01
5	1-1/4	TPR Round	275	6-3/4" (171)	4" (100)	Precision Ball	MP-05RTP-125-SW-TP01



## TOP PLATE FITTING

Swivel Top Plate Pattern

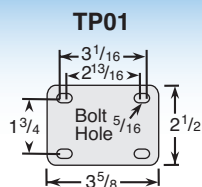

# MARQUEE (MP)

## TOP PLATE MODELS

FREE SWIVEL • TOTAL LOCK • DIRECTION LOCK

## SWIVEL TOP PLATE TOTAL LOCK MODELS

(LOCKS WHEEL AND SWIVEL)

Wheel Diameter (Inches)	Tread Width (Inches)	Wheel Description	Capacity (Lbs)	Load Height Inches (mm)	Swivel Radius Inches (mm)	Wheel Bearing	Model Number
5	1-1/4	TPR Flat	250	6-3/4" (171)	4" (100)	Precision Ball	MP-05TPP-125-TL-TP01
5	1-1/4	TPR Round	275	6-3/4" (171)	4" (100)	Precision Ball	MP-05RTP-125-TL-TP01



## SWIVEL TOP PLATE DIRECTION LOCK MODELS

(LOCKS SWIVEL ONLY)

Wheel Diameter (Inches)	Tread Width (Inches)	Wheel Description	Capacity (Lbs)	Load Height Inches (mm)	Swivel Radius Inches (mm)	Wheel Bearing	Model Number
5	1-1/4	TPR Flat	250	6-3/4" (171)	4" (100)	Precision Ball	MP-05TPP-125-DL-TP01
5	1-1/4	TPR Round	275	6-3/4" (171)	4" (100)	Precision Ball	MP-05RTP-125-DL-TP01



## TOP PLATE FITTING

Swivel Top Plate Pattern

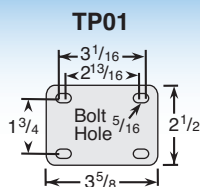

# MARQUEE (MP)

## GRIP RING STEM MODELS

FREE SWIVEL • TOTAL LOCK • DIRECTION LOCK

**IMPROVED**

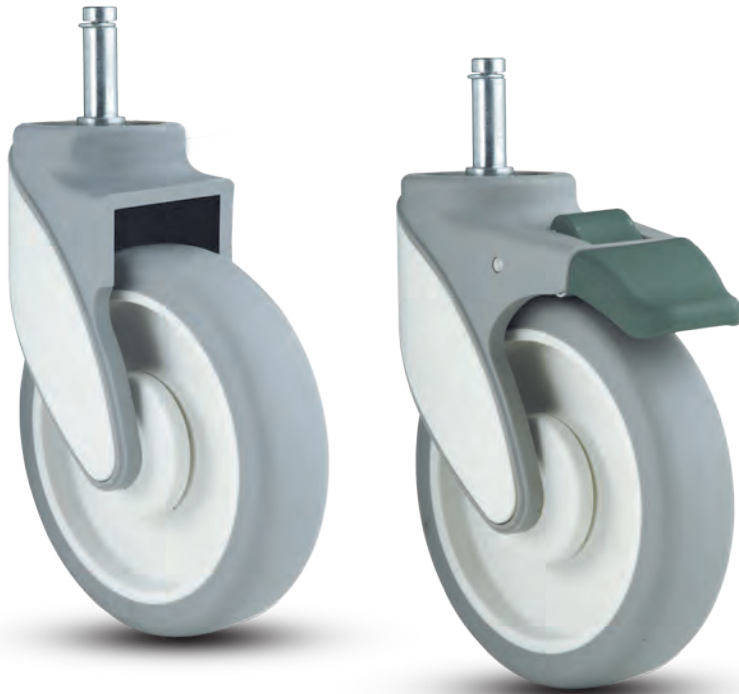

- APPLICATIONS**
- Food Service Equipment
  - Case Carts
  - Utility Carts
  - Medical Equipment
  - Institutional Equipment
  - Hospital Carts
  - Animal Cage Carts
  - Pharmaceutical Equipment

- FEATURES**
- Glass filled nylon body
  - New precision ball bearing raceway
  - **Total lock and direction lock brake models available**
  - Resistant to water and most chemicals
  - Precision bearing in wheel
  - Riveted axle
  - Standard color is light gray with white strip and white wheel core

Our MP Series features attractive two-tone accents.



Custom colors available. Consult factory for quantities.

## GRIP RING STEM MODELS

Precision sealed ball bearing raceway design for smooth, quiet maintenance free ride.

Wheel Diameter (Inches)	Tread Width (Inches)	Wheel Description	Capacity (Lbs)	Load Height Inches (mm)	Swivel Radius Inches (mm)	Wheel Bearing	Model Number
5	1-1/4	TPR Flat	250	6-5/8" (168)	4" (100)	Precision Ball	MP-05TPP-125-SW-_____
5	1-1/4	TPR Round	275	6-5/8" (168)	4" (100)	Precision Ball	MP-05RTP-125-SW-_____



Specify Grip Ring Stem (GR) code, see fittings below for dimensions:

## GRIP RING STEM FITTINGS

See fittings page for more options.





# MARQUEE (MP)

## TOP PLATE MODELS

FREE SWIVEL • TOTAL LOCK • DIRECTION LOCK

## GRIP RING STEM TOTAL LOCK MODELS

(LOCKS WHEEL AND SWIVEL)

Wheel Diameter (Inches)	Tread Width (Inches)	Wheel Description	Capacity (Lbs)	Load Height Inches (mm)	Swivel Radius Inches (mm)	Wheel Bearing	Model Number
5	1-1/4	TPR Flat	250	6-5/8" (168)	4" (100)	Precision Ball	MP-05TPP-125-TL-____
5	1-1/4	TPR Round	275	6-5/8" (168)	4" (100)	Precision Ball	MP-05RTP-125-TL-____



## GRIP RING STEM DIRECTION LOCK MODELS

(LOCKS SWIVEL ONLY)

Wheel Diameter (Inches)	Tread Width (Inches)	Wheel Description	Capacity (Lbs)	Load Height Inches (mm)	Swivel Radius Inches (mm)	Wheel Bearing	Model Number
5	1-1/4	TPR Flat	250	6-5/8" (168)	4" (100)	Precision Ball	MP-05TPP-125-DL-____
5	1-1/4	TPR Round	275	6-5/8" (168)	4" (100)	Precision Ball	MP-05RTP-125-DL-____



Stems ship with a loose bolt for easier alignment of the directional lock. The direction lock caster will not remain in a fixed position when used with a grip ring stem.

Specify Grip Ring Stem (GR) code, see fittings below for dimensions:

## GRIP RING STEM FITTINGS

See fittings page for more options.



# MARQUEE (MP)

## THREADED STEM MODELS

FREE SWIVEL • TOTAL LOCK • DIRECTION LOCK

**IMPROVED**



- APPLICATIONS**
- Food Service Equipment
  - Case Carts
  - Utility Carts
  - Medical Equipment
  - Institutional Equipment
  - Hospital Carts
  - Animal Cage Carts
  - Pharmaceutical Equipment

- FEATURES**
- Glass filled nylon body
  - New precision ball bearing raceway
  - **Total lock and direction lock brake models available**
  - Resistant to water and most chemicals
  - Precision bearing in wheel
  - Riveted axle
  - Standard color is light gray with white strip and white wheel core

Our MP Series features attractive two-tone accents.



Custom colors available. Consult factory for quantities.

## THREADED STEM MODELS

Precision sealed ball bearing raceway design for smooth, quiet maintenance free ride.

Wheel Diameter (Inches)	Tread Width (Inches)	Wheel Description	Capacity (Lbs)	Load Height Inches (mm)	Swivel Radius Inches (mm)	Wheel Bearing	Model Number
5	1-1/4	TPR Flat	250	6-5/8" (168)	4" (100)	Precision Ball	MP-05TPP-125-SW-_____
5	1-1/4	TPR Round	275	6-5/8" (168)	4" (100)	Precision Ball	MP-05RTP-125-SW-_____



Specify Threaded Stem (TS) code, see fittings below for dimensions:

## THREADED STEM FITTINGS

See fittings page for more options.

**TS02**



**TS03**

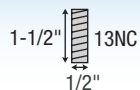

# MARQUEE (MP)

## TOP PLATE MODELS

FREE SWIVEL • TOTAL LOCK • DIRECTION LOCK

## THREADED STEM TOTAL LOCK MODELS

(LOCKS WHEEL AND SWIVEL)

Wheel Diameter (Inches)	Tread Width (Inches)	Wheel Description	Capacity (Lbs)	Load Height Inches (mm)	Swivel Radius Inches (mm)	Wheel Bearing	Model Number
5	1-1/4	TPR Flat	250	6-5/8" (168)	4" (100)	Precision Ball	MP-05TPP-125-TL-____
5	1-1/4	TPR Round	275	6-5/8" (168)	4" (100)	Precision Ball	MP-05RTP-125-TL-____



## THREADED STEM DIRECTION LOCK MODELS

(LOCKS SWIVEL ONLY)

Wheel Diameter (Inches)	Tread Width (Inches)	Wheel Description	Capacity (Lbs)	Load Height Inches (mm)	Swivel Radius Inches (mm)	Wheel Bearing	Model Number
5	1-1/4	TPR Flat	250	6-5/8" (168)	4" (100)	Precision Ball	MP-05TPP-125-DL-____
5	1-1/4	TPR Round	275	6-5/8" (168)	4" (100)	Precision Ball	MP-05RTP-125-DL-____



Stems ship with a loose bolt for easier alignment of the directional lock.

Specify Threaded Stem (TS) code, see fittings below for dimensions:

## THREADED STEM FITTINGS

See fittings page for more options.

**TS02**

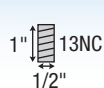

**TS03**

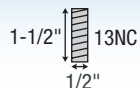

# PLASTIC (PG)

## TOP PLATE MODELS

FREE SWIVEL • TOTAL LOCK • DIRECTION LOCK



Standard color is silk grey

### APPLICATIONS

- Food Service Equipment
- Case Carts
- Utility Carts
- Medical Equipment
- Institutional Equipment
- Hospital Carts
- Animal Cage Carts
- Cart Washable applications

4", 5", 6" & 8" wheel diameters

### FEATURES

- Maintenance free
- Sealed precision bearing raceway
- Total Lock Brake models lock both swivel and wheel
- Directional lock models lock swivel only (helps with steering)
- Wheel feature precision bearings and full thread guards
- Rigs are made with glass filled nylon for added strength
- Resistance to most chemicals
- Recessed axle with plastic cap covers
- Operating temperatures good to 210° F intermittent

Our PG series provides you with that smooth European look and design.

## SWIVEL TOP PLATE MODELS

Wheel Diameter (Inches)	Tread Width (Inches)	Wheel Description	Capacity (Lbs)	Load Height Inches (mm)	Swivel Radius Inches (mm)	Wheel Bearing	Model Number
4	1-1/4	Rubber on Plastic	220	5-13/16" (148)	3-15/32" (88)	Precision Ball	PG-04RPP-125-SW-TP01
4	1-1/4	Polyurethane TPU	220	5-13/16" (148)	3-15/32" (88)	Precision Ball	PG-04PYP-125-SW-TP01
5	1-1/4	Rubber on Plastic	220	6-39/64" (168)	4-5/6" (110)	Precision Ball	PG-05RPP-125-SW-TP01
5	1-1/4	Polyurethane TPU	220	6-39/64" (168)	4-5/6" (110)	Precision Ball	PG-05PYP-125-SW-TP01
6	1-1/4	Rubber on Plastic	264	7-25/32" (198)	4-57/64" (124)	Precision Ball	PG-06RPP-125-SW-TP01
6	1-1/4	Polyurethane TPU	264	7-25/32" (198)	4-57/64" (124)	Precision Ball	PG-06PYP-125-SW-TP01
8	1-1/4	Rubber on Plastic	264	10" (254)	6-1/2" (165)	Precision Ball	PG-08RPP-125-SW-TP01
8	1-1/4	Polyurethane TPU	264	10" (254)	6-1/2" (165)	Precision Ball	PG-08PYP-125-SW-TP01



## TOP PLATE FITTING

Swivel Top Plate Pattern

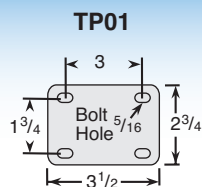

Dark grey also available on all PG models shown on pages 92-97. Change PG to PD (Example: PD-04RPP-SW-HKU1)



# PLASTIC (PG)

## TOP PLATE MODELS

FREE SWIVEL • TOTAL LOCK • DIRECTION LOCK

### SWIVEL TOP PLATE TOTAL LOCK MODELS

(LOCKS WHEEL AND SWIVEL)

Wheel Diameter (Inches)	Tread Width (Inches)	Wheel Description	Capacity (lbs)	Load Height Inches (mm)	Swivel Radius Inches (mm)	Wheel Bearing	Model Number
4	1-1/4	Rubber on Plastic	220	5-13/16" (148)	4-21/64" (110)	Precision Ball	PG-04RPP-125-TL-TP01
4	1-1/4	Polyurethane TPU	220	5-13/16" (148)	4-21/64" (110)	Precision Ball	PG-04PYP-125-TL-TP01
5	1-1/4	Rubber on Plastic	220	6-39/64" (168)	4-23/32" (120)	Precision Ball	PG-05RPP-125-TL-TP01
5	1-1/4	Polyurethane TPU	220	6-39/64" (168)	4-23/32" (120)	Precision Ball	PG-05PYP-125-TL-TP01
6	1-1/4	Rubber on Plastic	264	7-25/32" (198)	5-9/32" (134)	Precision Ball	PG-06RPP-125-TL-TP01
6	1-1/4	Polyurethane TPU	264	7-25/32" (198)	5-9/32" (134)	Precision Ball	PG-06PYP-125-TL-TP01
8	1-1/4	Rubber on Plastic	264	10" (254)	5-29/32" (150)	Precision Ball	PG-08RPP-125-TL-TP01
8	1-1/4	Polyurethane TPU	264	10" (254)	5-29/32" (150)	Precision Ball	PG-08PYP-125-TL-TP01



### SWIVEL TOP PLATE DIRECTION LOCK MODELS

(LOCKS SWIVEL ONLY)

Wheel Diameter (Inches)	Tread Width (Inches)	Wheel Description	Capacity (lbs)	Load Height Inches (mm)	Swivel Radius Inches (mm)	Wheel Bearing	Model Number
4	1-1/4	Rubber on Plastic	220	5-13/16" (148)	4-21/64" (110)	Precision Ball	PG-04RPP-125-DL-TP01
4	1-1/4	Polyurethane TPU	220	5-13/16" (148)	4-21/64" (110)	Precision Ball	PG-04PYP-125-DL-TP01
5	1-1/4	Rubber on Plastic	220	6-39/64" (168)	4-23/32" (120)	Precision Ball	PG-05RPP-125-DL-TP01
5	1-1/4	Polyurethane TPU	220	6-39/64" (168)	4-23/32" (120)	Precision Ball	PG-05PYP-125-DL-TP01



Our Directional Lock casters are designed to lock the swivel but not the wheel allowing you to steer your equipment. The directional lock feature is designed to break free under heavier load when the unit is traversing a corner only to lock back into position when the unit resumes a straight course.

### TOP PLATE FITTING

Swivel Top Plate Pattern

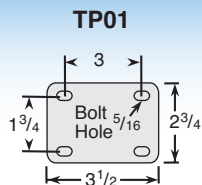

# PLASTIC (PG)

## HOLLOW KINGPIN MODELS

FREE SWIVEL • TOTAL LOCK • DIRECTION LOCK

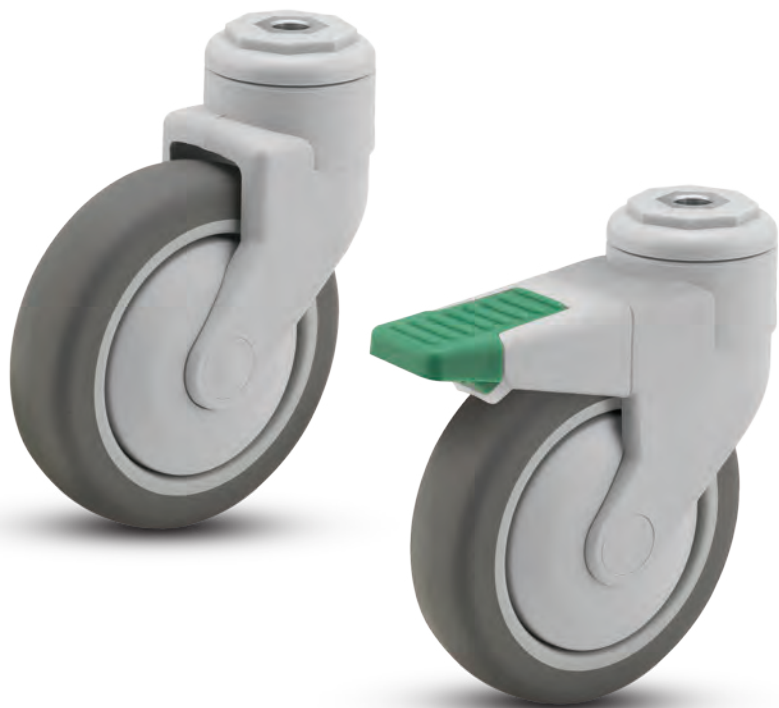

- APPLICATIONS**
- Food Service Equipment
  - Case Carts
  - Utility Carts
  - Medical Equipment
  - Institutional Equipment
  - Hospital Carts
  - Animal Cage Carts
  - Cart Washable applications

4", 5", 6"  
& 8" wheel  
diameters

- FEATURES**
- Maintenance free
  - Sealed precision bearing raceway
  - Total Lock Brake models lock both swivel and wheel
  - Directional lock models lock swivel only (helps with steering)
  - Wheel feature precision bearings and full thread guards
  - Rigs are made with glass filled nylon for added strength
  - Resistance to most chemicals
  - Recessed axle with plastic cap covers
  - Operating temperatures good to 210° F intermittent

Our PG series provides you with that smooth European look and design.

## HOLLOW KINGPIN MODELS

Wheel Diameter (Inches)	Tread Width (Inches)	Wheel Description	Capacity (Lbs)	Load Height Inches (mm)	Swivel Radius Inches (mm)	Wheel Bearing	Model Number
4	1-1/4	Rubber on Plastic	220	5-45/64" (145)	3-15/32" (88)	Precision Ball	PG-04RPP-125-SW-HKU1
4	1-1/4	Polyurethane TPU	220	5-45/64" (145)	3-15/32" (88)	Precision Ball	PG-04PYP-125-SW-HKU1
5	1-1/4	Rubber on Plastic	220	6-1/2" (165)	4-5/6" (110)	Precision Ball	PG-05RPP-125-SW-HKU1
5	1-1/4	Polyurethane TPU	220	6-1/2" (165)	4-5/6" (110)	Precision Ball	PG-05PYP-125-SW-HKU1
6	1-1/4	Rubber on Plastic	264	7-11/16" (195)	4-57/64" (124)	Precision Ball	PG-06RPP-125-SW-HKU1
6	1-1/4	Polyurethane TPU	264	7-11/16" (195)	4-57/64" (124)	Precision Ball	PG-06PYP-125-SW-HKU1
8	1-1/4	Rubber on Plastic	264	9-7/8" (251)	6-1/2" (165)	Precision Ball	PG-08RPP-125-SW-HKU1
8	1-1/4	Polyurethane TPU	264	9-7/8" (251)	6-1/2" (165)	Precision Ball	PG-08PYP-125-SW-HKU1



## HOLLOW KINGPIN

Caster is provided unassembled to make it easy to add your choice of fitting. If you would like these assembled change from HKU1 to HKO1. 1/2 I.D.

Please see fitting pages for stems that can be added to this series.



# PLASTIC (PG)

## HOLLOW KINGPIN MODELS

FREE SWIVEL • TOTAL LOCK • DIRECTION LOCK

### HOLLOW KINGPIN TOTAL LOCK MODELS

(LOCKS WHEEL AND SWIVEL)

Wheel Diameter (Inches)	Tread Width (Inches)	Wheel Description	Capacity (lbs)	Load Height Inches (mm)	Swivel Radius Inches (mm)	Wheel Bearing	Model Number
4	1-1/4	Rubber on Plastic	220	5-45/64" (145)	4-21/64" (110)	Precision Ball	PG-04RPP-125-TL-HKU1
4	1-1/4	Polyurethane TPU	220	5-45/64" (145)	4-21/64" (110)	Precision Ball	PG-04PYP-125-TL-HKU1
5	1-1/4	Rubber on Plastic	220	6-1/2" (165)	4-23/32" (120)	Precision Ball	PG-05RPP-125-TL-HKU1
5	1-1/4	Polyurethane TPU	220	6-1/2" (165)	4-23/32" (120)	Precision Ball	PG-05PYP-125-TL-HKU1
6	1-1/4	Rubber on Plastic	264	7-11/16" (195)	5-9/32" (134)	Precision Ball	PG-06RPP-125-TL-HKU1
6	1-1/4	Polyurethane TPU	264	7-11/16" (195)	5-9/32" (134)	Precision Ball	PG-06PYP-125-TL-HKU1
8	1-1/4	Rubber on Plastic	264	9-7/8" (251)	5-29/32" (150)	Precision Ball	PG-08RPP-125-TL-HKU1
8	1-1/4	Polyurethane TPU	264	9-7/8" (251)	5-29/32" (150)	Precision Ball	PG-08PYP-125-TL-HKU1



### HOLLOW KINGPIN DIRECTION LOCK MODELS

(LOCKS SWIVEL ONLY)

Wheel Diameter (Inches)	Tread Width (Inches)	Wheel Description	Capacity (lbs)	Load Height Inches (mm)	Swivel Radius Inches (mm)	Wheel Bearing	Model Number
4	1-1/4	Rubber on Plastic	220	5-45/64" (145)	4-21/64" (110)	Precision Ball	PG-04RPP-125-DL-HKU1
4	1-1/4	Polyurethane TPU	220	5-45/64" (145)	4-21/64" (110)	Precision Ball	PG-04PYP-125-DL-HKU1
5	1-1/4	Rubber on Plastic	220	6-1/2" (165)	4-23/32" (120)	Precision Ball	PG-05RPP-125-DL-HKU1
5	1-1/4	Polyurethane TPU	220	6-1/2" (165)	4-23/32" (120)	Precision Ball	PG-05PYP-125-DL-HKU1



Our Directional Lock casters are designed to lock the swivel but not the wheel allowing you to steer your equipment. The directional lock feature is designed to break free under heavier load when the unit is traversing a corner only to lock back into position when the unit resumes a straight course.

## HOLLOW KINGPIN

Caster is provided unassembled to make it easy to add your choice of fitting. If you would like these assembled change from HKU1 to HKO1. 1/2 I.D.

Please see fitting pages for stems that can be added to this series.



# PLASTIC (PG)

## THREADED / GRIP RING STEM MODELS

FREE SWIVEL • TOTAL LOCK • DIRECTION LOCK



- APPLICATIONS**
- Food Service Equipment
  - Case Carts
  - Utility Carts
  - Medical Equipment
  - Institutional Equipment
  - Hospital Carts
  - Animal Cage Carts
  - Cart Washable applications

4", 5", 6" & 8" wheel diameters

- FEATURES**
- Maintenance free
  - Sealed precision bearing raceway
  - Total Lock Brake models lock both swivel and wheel
  - Directional lock models lock swivel only (helps with steering)
  - Wheel feature precision bearings and full thread guards
  - Rigs are made with glass filled nylon for added strength
  - Resistance to most chemicals
  - Recessed axle with plastic cap covers
  - Operating temperatures good to 210° F intermittent

Our PG series provides you with that smooth European look and design.

### THREADED STEM MODELS

Wheel Diameter (Inches)	Tread Width (Inches)	Wheel Description	Capacity (lbs)	Load Height Inches (mm)	Swivel Radius Inches (mm)	Wheel Bearing	Model Number
4	1-1/4	Rubber on Plastic	220	5-45/64" (145)	3-15/32" (88)	Precision Ball	PG-04RPP-125-SW-___
4	1-1/4	Polyurethane TPU	220	5-45/64" (145)	3-15/32" (88)	Precision Ball	PG-04PYP-125-SW-___
5	1-1/4	Rubber on Plastic	220	6-1/2" (165)	4-5/6" (110)	Precision Ball	PG-05RPP-125-SW-___
5	1-1/4	Polyurethane TPU	220	6-1/2" (165)	4-5/6" (110)	Precision Ball	PG-05PYP-125-SW-___
6	1-1/4	Rubber on Plastic	264	7-11/16" (195)	4-57/64" (124)	Precision Ball	PG-06RPP-125-SW-___
6	1-1/4	Polyurethane TPU	264	7-11/16" (195)	4-57/64" (124)	Precision Ball	PG-06PYP-125-SW-___
8	1-1/4	Rubber on Plastic	264	9-7/8" (251)	6-1/2" (165)	Precision Ball	PG-08RPP-125-SW-___
8	1-1/4	Polyurethane TPU	264	9-7/8" (251)	6-1/2" (165)	Precision Ball	PG-08PYP-125-SW-___



### STEM FITTINGS

Easy to install stem. See fittings page for more options.

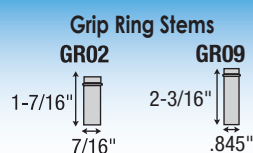

Specify Threaded Stem (TS) code, see fittings below for dimensions:



# PLASTIC (PG)

## THREADED / GRIP RING STEM MODELS

FREE SWIVEL • TOTAL LOCK • DIRECTION LOCK

### THREADED STEM TOTAL LOCK MODELS

(LOCKS WHEEL AND SWIVEL)

Wheel Diameter (Inches)	Tread Width (Inches)	Wheel Description	Capacity (Lbs)	Load Height Inches (mm)	Swivel Radius Inches (mm)	Wheel Bearing	Model Number
4	1-1/4	Rubber on Plastic	220	5-45/64" (145)	4-21/64" (110)	Precision Ball	PG-04RPP-125-TL-__
4	1-1/4	Polyurethane TPU	220	5-45/64" (145)	4-21/64" (110)	Precision Ball	PG-04PYP-125-TL-__
5	1-1/4	Rubber on Plastic	220	6-1/2" (165)	4-23/32" (120)	Precision Ball	PG-05RPP-125-TL-__
5	1-1/4	Polyurethane TPU	220	6-1/2" (165)	4-23/32" (120)	Precision Ball	PG-05PYP-125-TL-__
6	1-1/4	Rubber on Plastic	264	7-11/16" (195)	5-9/32" (134)	Precision Ball	PG-06RPP-125-TL-__
6	1-1/4	Polyurethane TPU	264	7-11/16" (195)	5-9/32" (134)	Precision Ball	PG-06PYP-125-TL-__
8	1-1/4	Rubber on Plastic	264	9-7/8" (251)	5-29/32" (150)	Precision Ball	PG-08RPP-125-TL-__
8	1-1/4	Polyurethane TPU	264	9-7/8" (251)	5-29/32" (150)	Precision Ball	PG-08PYP-125-TL-__



### THREADED STEM DIRECTION LOCK MODELS

(LOCKS SWIVEL ONLY)

Wheel Diameter (Inches)	Tread Width (Inches)	Wheel Description	Capacity (Lbs)	Load Height Inches (mm)	Swivel Radius Inches (mm)	Wheel Bearing	Model Number
4	1-1/4	Rubber on Plastic	220	5-45/64" (145)	4-21/64" (110)	Precision Ball	PG-04RPP-125-DL-__
4	1-1/4	Polyurethane TPU	220	5-45/64" (145)	4-21/64" (110)	Precision Ball	PG-04PYP-125-DL-__
5	1-1/4	Rubber on Plastic	220	6-1/2" (165)	4-15/16" (125)	Precision Ball	PG-05RPP-125-DL-__
5	1-1/4	Polyurethane TPU	220	6-1/2" (165)	4-15/16" (125)	Precision Ball	PG-05PYP-125-DL-__



Our Directional Lock casters are designed to lock the swivel but not the wheel allowing you to steer your equipment. The directional lock feature is designed to break free under heavier load when the unit is traversing a corner only to lock back into position when the unit resumes a straight course.

Stems ship with a loose bolt for easier alignment of the directional lock. The direction lock caster will not remain in a fixed position when used with a grip ring stem.

### STEM FITTINGS

Easy to install stem. See fittings page for more options.

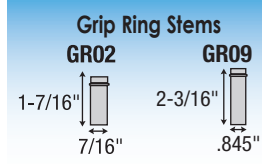
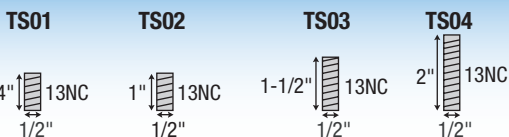

Specify Threaded Stem (TS) code, see fittings below for dimensions:

# ANTISTATIC

Electronic equipment can be damaged by the electrostatic discharge of a simple human touch. Damage caused by this discharge is a very costly and frustrating to the medical industry. MedCaster antistatic casters and wheels can help minimize the risk of electrostatic discharge. Our casters and wheels conforms to CEN standards with resistance values < 10,000 ohms (measured at 500V DC, with minimum output of 50 V DC at 1,000 ohms resistance).

## ANTISTATIC CHROME HOSPITAL (CH) & STAINLESS STEEL (SS)

Page 99



## NYLON ANTISTATIC (NA)

Page 100



## RHOMBUS 367 & 364 ANTISTATIC

Page 101



## TWIN-MED ANTISTATIC (TA)

Page 102-103



# ANTISTATIC CHROME HOSPITAL (CH) AND STAINLESS STEEL (SS)

PLATE • HOLLOW RIVET • GRIP RING • THREADED • ROUND • SQUARE • SWIVEL TOTAL LOCK • DIRECTION LOCK



- APPLICATIONS**
- Food Service
  - Case Carts
  - Utility Carts
  - Hospital Equipment
  - Institutional Equipment
  - Store Fixtures
  - Medical equipment

- FEATURES**
- Chrome Plated Finish
  - Dual Ball Swivel Raceways for added strength
  - **Total Lock Brake** models lock both swivel and wheel
  - Directional lock models lock swivel only (helps with steering)
  - Precision ball bearings in wheels for easier rollability
  - Wheels have full thread guards for added protection

Antistatic models can help protect your equipment

## FREE SWIVEL MODELS

Wheel Diameter (Inches)	Tread Width (Inches)	Wheel Description	Capacity (Lbs)	Load Height * Inches (mm)	Swivel Radius Inches (mm)	Wheel Bearing	Model Number
3	1-1/4	Conductive Rubber	190	4-7/16" (113)	2-29/32" (74)	Annular Ball	CH-03CRB-125-SW-___
4	1-1/4	Conductive Rubber	240	5-7/16" (138)	3-37/64" (91)	Annular Ball	CH-04CRB-125-SW-___
5	1-1/4	Conductive Rubber	260	6-7/16" (163)	4-7/32" (108)	Annular Ball	CH-05CRB-125-SW-___
6	1-1/4	Conductive Rubber	260	7-13/32" (188)	4-39/64 (117)	Annular Ball	CH-06CRB-125-SW-___



Rigid model change SW to RG

## TOTAL LOCK MODELS

Wheel Diameter (Inches)	Tread Width (Inches)	Wheel Description	Capacity (Lbs)	Load Height * Inches (mm)	Swivel Radius Inches (mm)	Wheel Bearing	Model Number
3	1-1/4	Conductive Rubber	190	4-7/16" (113)	4-1/4" (108)	Annular Ball	CH-03CRB-125-TL-___
4	1-1/4	Conductive Rubber	240	5-7/16" (138)	4-35/64" (115)	Annular Ball	CH-04CRB-125-TL-___
5	1-1/4	Conductive Rubber	260	6-7/16" (163)	4-55/64" (123)	Annular Ball	CH-05CRB-125-TL-___
6	1-1/4	Conductive Rubber	260	7-13/32" (188)	4-55/64" (123)	Annular Ball	CH-06CRB-125-TL-___



**Total Lock**  
Change "SW" to "TL". **Red** sticker on pedal.

## SWIVEL LOCK MODELS MODELS

Wheel Diameter (Inches)	Tread Width (Inches)	Wheel Description	Capacity (Lbs)	Load Height * Inches (mm)	Swivel Radius Inches (mm)	Wheel Bearing	Model Number
3	1-1/4	Conductive Rubber	190	4-7/16" (113)	4-1/4" (108)	Annular Ball	CH-03CRB-125-DL-___
4	1-1/4	Conductive Rubber	240	5-7/16" (138)	4-35/64" (115)	Annular Ball	CH-04CRB-125-DL-___
5	1-1/4	Conductive Rubber	260	6-7/16" (163)	4-55/64" (123)	Annular Ball	CH-05CRB-125-DL-___
6	1-1/4	Conductive Rubber	260	7-13/32" (188)	4-55/64" (123)	Annular Ball	CH-06CRB-125-DL-___



**Direction Lock**  
Change "SW" to "DL". **Green** sticker on pedal.

\*For non-plate models subtract approximately 1/8" from load height.

For stainless steel models change "CH" to "SS"

Specify Fitting code

## FITTING OPTIONS

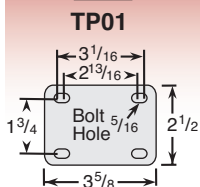

**Plate**  
TP01  
**Hollow Rivet**  
HKU1 unassembled  
HKO1 assembled  
1/2 I.D.

**Grip Ring Stem**  
GR02  
1-7/16" (44mm)  
7/16" (22mm)

**Threaded Stem**  
TS02  
1" (25.4mm) 13NC  
1/2"

**Round Stem**  
RS01  
45mm  
22mm

See more fitting options on page 4 and 5.

# NEXT GENERATION NYLON ANTISTATIC (NA)

PLATE • HOLLOW RIVET • GRIP RING • THREADED  
FREE SWIVEL • TOTAL LOCK • DIRECTION LOCK



- APPLICATIONS**
- Food Service
  - Case Carts
  - Utility Carts
  - Hospital Equipment
  - Institutional Equipment
  - Store Fixtures
  - Medical equipment

Precision sealed ball bearing raceway design for smooth, quiet maintenance free ride.

- FEATURES**
- Maintenance free
  - Sealed precision bearing raceway, smooth and quiet
  - **Total Lock Brake** models lock both swivel and wheel
  - Directional lock models lock swivel only (helps with steering)
  - Wheels feature sealed precision ball bearings and full thread guards
  - Resistance to most chemicals
  - Zinc plated top plate
  - Recessed axle with plastic cap covers

Antistatic models can help protect your equipment

## FREE SWIVEL MODELS

Wheel Diameter (Inches)	Tread Width (Inches)	Wheel Description	Capacity (Lbs)	Load Height Inches (mm)*	Swivel Radius Inches (mm)	Wheel Bearing	Model Number
3	1-1/4	QuikStart TPR	180	4-1/4" (108)	2-13/16" (72)	Precision Ball	NA-03QDP-125-SW-__
4	1-1/4	QuikStart TPR	220	5-3/4" (146)	3-7/16" (87)	Precision Ball	NA-04QDP-125-SW-__
5	1-1/4	QuikStart TPR	240	6-7/8" (174)	4" (102)	Precision Ball	NA-05QDP-125-SW-__
6	1-1/4	QuikStart TPR	264	7-11/16" (195)	4-9/16" (116)	Precision Ball	NA-06QDP-125-SW-__



Rigid models available. Change SW to RG.

## TOTAL LOCK MODELS (LOCKS WHEEL AND SWIVEL)

Wheel Diameter (Inches)	Tread Width (Inches)	Wheel Description	Capacity (Lbs)	Load Height Inches (mm)*	Swivel Radius Inches (mm)	Wheel Bearing	Model Number
3	1-1/4	QuikStart TPR	180	4-1/4" (108)	3-3/4" (95)	Precision Ball	NA-03QDP-125-TL-__
4	1-1/4	QuikStart TPR	220	5-3/4" (146)	4-7/16" (112)	Precision Ball	NA-04QDP-125-TL-__
5	1-1/4	QuikStart TPR	240	6-7/8" (174)	4-7/16" (112)	Precision Ball	NA-05QDP-125-TL-__
6	1-1/4	QuikStart TPR	264	7-11/16" (195)	4-9/16" (116)	Precision Ball	NA-06QDP-125-TL-__



## DIRECTION LOCK MODELS (LOCKS WHEEL AND SWIVEL)

Wheel Diameter (Inches)	Tread Width (Inches)	Wheel Description	Capacity (Lbs)	Load Height Inches (mm)*	Swivel Radius Inches (mm)	Wheel Bearing	Model Number
3	1-1/4	QuikStart TPR	180	4-1/4" (108)	3-3/4" (95)	Precision Ball	NA-03QDP-125-DL-__
4	1-1/4	QuikStart TPR	220	5-3/4" (146)	4-7/16" (112)	Precision Ball	NA-04QDP-125-DL-__
5	1-1/4	QuikStart TPR	240	6-7/8" (174)	4-7/16" (112)	Precision Ball	NA-05QDP-125-DL-__
6	1-1/4	QuikStart TPR	264	7-11/16" (195)	4-9/16" (116)	Precision Ball	NA-06QDP-125-DL-__

New rigid brake models now available on 5" models. Change TL to RB

\*For non-plate models subtract approximately 1/8" from load height.

Specify Fitting code ↑

## FITTING OPTIONS

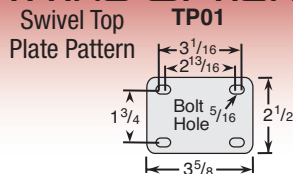

**Hollow Rivet**  
HKU1 unassembled  
HKO1 assembled  
1/2 I.D.

### Grip Ring Stem

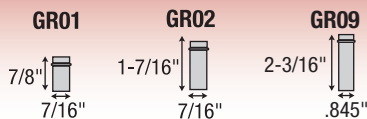

### Threaded Stem

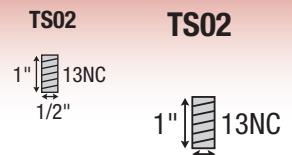

Other fittings available such as RS01, RS03, SQ01 and SQ03. See page 4-5 for more options.

RHOMBUS



# 367 & 364 ANTISTATIC



367A Swivel  
364A Rigid



32C black antistatic wheel shown

## APPLICATIONS

- Care beds
- Medical-technical equipment
- Physical therapy equipment
- Rehab apparatus

## FEATURES

- Antistatic caster
- Stamped and drawn horn assembly
- Zinc-plated
- Double ball raceway that's sealed

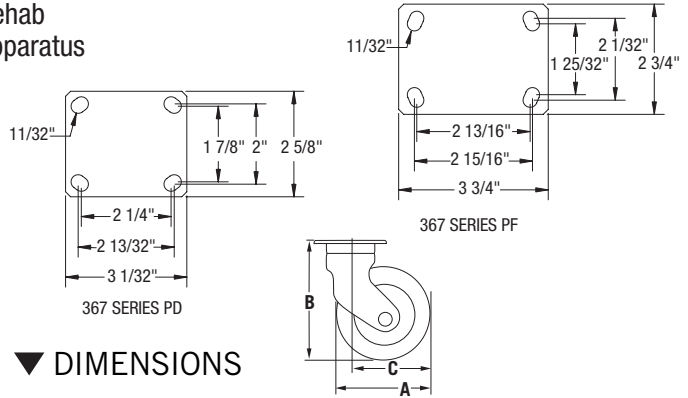

## ▼ DIMENSIONS

### 367/364 Series with Top Plate

	3"	4"	5"	6"
<b>A:</b> Wheel Diameter	3" (80mm)	4" (100mm)	5" (125mm)	6" (150mm)
<b>B:</b> Overall Height	4 1/2" (117mm)	5 1/4" (137mm)	6 1/2" (163mm)	7 1/2" (189mm)
<b>C:</b> Swivel Radius	3 1/4" (84mm)	3 1/2" (92mm)	3 1/4" (85mm)	4" (100mm)
<b>C:</b> Swivel Radius w/ brake	4" (100mm)	4 1/4" (106mm)	4 1/2" (110mm)	4 1/2" (110mm)

## ▼ SPECIFICATIONS

Wheel Diameter	Tread Width	Wheel Material	Wheel Bearing	Load Cap (lb)	Top Plate Caster	Top Plate EDP	Hollow Kingpin Caster	Hollow Kingpin EDP
3" (80mm)	1 1/4" (32mm)	TPR	Precision	220	364A35K080AZPF	07276		
3" (80mm)	1 1/4" (32mm)	TPR	Precision	220	367A35K080AZPF	07395	367A35K080AZLD	06304
3" (80mm)	1 1/4" (32mm)	TPR	Precision	220	367H35K080AZPF	08029	367H35K080AZLD	06245
3" (80mm)	1 1/4" (32mm)	TPR	Precision	220	367R35K080AZPF	06111		
4" (100mm)	1 1/4" (32mm)	TPR	Precision	220	364A35K100AZPF	07340		
4" (100mm)	1 1/4" (32mm)	TPR	Precision	220	367A35K100AZPF	07488	367A35K100AZLD	06307
4" (100mm)	1 1/4" (32mm)	TPR	Precision	220	367H35K100AZPF	07986	367H35K100AZLD	06306
4" (100mm)	1 1/4" (32mm)	TPR	Precision	220	367R35K100AZPF	06112		
5" (125mm)	1 1/4" (32mm)	TPR	Precision	220	364A35K125AZPF	07356		
5" (125mm)	1 1/4" (32mm)	TPR	Precision	220	367A35K125AZPF	07571	367A35K125AZLD	07571
5" (125mm)	1 1/4" (32mm)	TPR	Precision	220	367H35K125AZPF	08015	367H35K125AZLD	06309
5" (125mm)	1 1/4" (32mm)	TPR	Precision	220	367R35K125AZPF	06113		
6" (150mm)	1 1/4" (32mm)	TPR	Precision	220	364A35K150AZPF	07298		
6" (150mm)	1 1/4" (32mm)	TPR	Precision	220	367A35K150AZPF	07612	367A35K150AZLD	02109
6" (150mm)	1 1/4" (32mm)	TPR	Precision	220	367H35K150AZPF	08074	367H35K150AZLD	02113
6" (150mm)	1 1/4" (32mm)	TPR	Precision	220	367R35K150AZPF	06124		

## ▼ WHEEL OPTIONS

32C features black crown tread. To order change 35K to 32C.  
35K features grey round tread.

## ▼ MOUNTING OPTIONS



## ▼ LOCK OPTIONS



# TWIN-MED ANTISTATIC (TA)

THREADED STEM MODELS  
FREE SWIVEL • BRAKE

**NEW**



**APPLICATIONS**

- Nursing Home Beds
- Medical Carts
- Diagnostic Equipment
- Electronic Equipment
- Patient Aids
- Patient Lifts

**FEATURES**

- New Twin-Med antistatic come with our new rounded pedal design
- Wheels feature precision ball bearings for quieter smoother operation
- Softer quieter TPR tread design
- Double ball bearing located in the swivel raceway on 4" models
- 5" models feature a sealed precision bearing in the swivel raceway
- Wheels have easy rollability
- Designed to protect axle/bearing areas from hair/water
- Total Lock models lock both the wheel and swivel
- Directional Lock (locks swivel) models are available. Please consult factory.

Special colors available.  
Consult factory.



## FREE SWIVEL MODELS

Wheel Diameter (Inches)	Tread Width Inches (mm)	Wheel Description	Capacity (Lbs)	Load Height Inches (mm)	Swivel Radius Inches (mm)	Wheel Bearing	Model Number
4	2-39/64" (66)	Thermoplastic Rubber	220	5" (127)	3-1/8" (79)	Precision Ball	TA-04ATP-281-SW-____
5	3" (76)	Thermoplastic Rubber	246	6" (152)	4" (102)	Precision Ball	TA-05ATP-281-SW-____

## TOTAL LOCK MODELS (LOCKS WHEEL AND SWIVEL)

Wheel Diameter (Inches)	Tread Width Inches (mm)	Wheel Description	Capacity (Lbs)	Load Height Inches (mm)	Swivel Radius Inches (mm)	Wheel Bearing	Model Number
4	2-39/64" (66)	Thermoplastic Rubber	220	5" (127)	3-1/8" (79)	Precision Ball	TA-04ATP-281-TL-____
5	3" (76)	Thermoplastic Rubber	246	6" (152)	4" (102)	Precision Ball	TA-05ATP-281-TL-____

## THREADED STEM FITTINGS

See fittings page for more options.

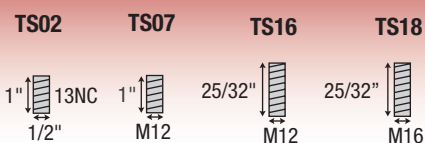

Specify Threaded Stem (TS) code, see fittings below for dimensions:

# TWIN-MED ANTISTATIC (TA)

TOP PLATE MODELS  
FREE SWIVEL • BRAKE

**NEW**



- APPLICATIONS**
- Nursing Home Beds
  - Medical Carts
  - Diagnostic Equipment
  - Electronic Equipment
  - Patient Aids
  - Patient Lifts

- FEATURES**
- New Twin-Med antistatic come with our new rounded pedal design
  - Wheels feature precision ball bearings for quieter smoother operation
  - Softer quieter TPR tread design
  - Double ball bearing located in the swivel raceway on 4" models
  - 5" models feature a sealed precision bearing in the swivel raceway
  - Wheels have easy rollability
  - Designed to protect axle/bearing areas from hair/water
  - Total Lock models lock both the wheel and swivel
  - Directional Lock (locks swivel) models are available. Please consult factory.

Special colors available.  
Consult factory.



## FREE SWIVEL MODELS

Wheel Diameter (Inches)	Tread Width Inches (mm)	Wheel Description	Capacity (Lbs)	Load Height Inches (mm)	Swivel Radius Inches (mm)	Wheel Bearing	Model Number
4	2-39/64" (66)	Thermoplastic Rubber	220	5-3/8" (137)	3-1/8" (79)	Precision Ball	TA-04ATP-281-SW-____
5	3" (76)	Thermoplastic Rubber	246	6-3/8" (162)	4" (102)	Precision Ball	TA-05ATP-281-SW-____

## TOTAL LOCK MODELS (LOCKS WHEEL AND SWIVEL)

Wheel Diameter (Inches)	Tread Width Inches (mm)	Wheel Description	Capacity (Lbs)	Load Height Inches (mm)	Swivel Radius Inches (mm)	Wheel Bearing	Model Number
4	2-39/64" (66)	Thermoplastic Rubber	220	5-3/8" (137)	3-1/8" (79)	Precision Ball	TA-04ATP-281-TL-____
5	3" (76)	Thermoplastic Rubber	246	6-3/8" (162)	4" (102)	Precision Ball	TA-05ATP-281-TL-____

## TOP PLATE FITTINGS

See fittings page for more options.

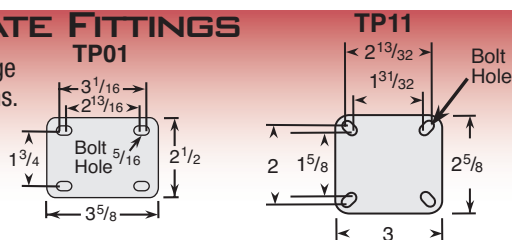

\*Change "TL" to "DL" for Direction Lock models. Available on all precision bearing models. TG-04TPA-281-DL-TP01 shown.

# MEDCASTER BED CASTERS

## PRIMACY TWIN WHEEL (PT)

**NEW**



Dual wheel smooth integrated central locking (page 106).

## MED-ULTRA (MU)



Hooded twin wheel easy turning in tight spots (page 107).

## TWIN TECH ULTRA (TU)



Unhooded twin wheel easy turning in tight spots (page 108).

## PRIMACY SINGLE (PS)

**NEW**



Dual wheel smooth integrated central locking (page 109).

## PRIMACY COVER (PC) AND (PP)

**NEW**



TPR cover in one-piece design. PP version includes precision bearing in the raceway (page 110-111).

## MED-BED (MB)



New central lock brake design (page 112).

### Typical Configurations for our Hospital bed Casters

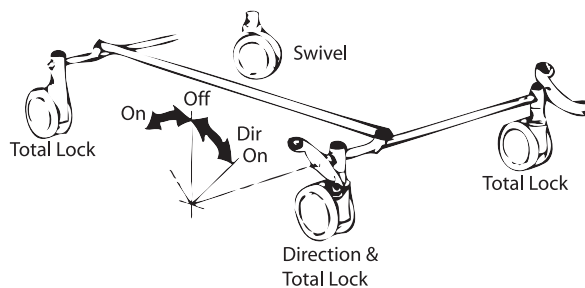
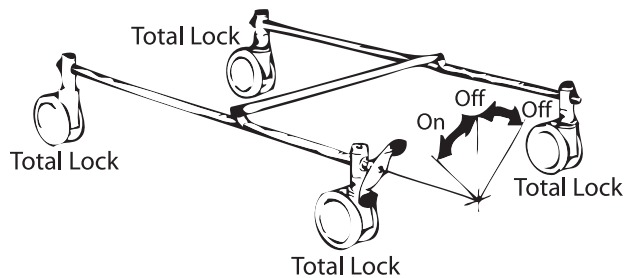

See page 105 for levers and adaptors



# BED ACCESSORIES

## MedCaster Bed System Caster Accessories



Double lever, round profile

**T3L:** Left hand  
**T3R:** Right hand



Comes with red and green (off/on) pedal caps



Steel adapter

**CC1**



Adapter

**BB5**



Chrome change lever

**BB1**

## Rhombus Bed System Caster Accessories

Rhombus Caster pedals combine ergonomics and durability in an easy-to-operate design that functions flawlessly with Rhombus Caster braking systems.

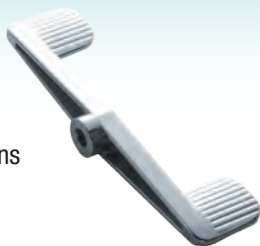

**Foot Pedal Double**

Description	11mm Hex Hole EDP	7/16" Hex Hole EDP
left	DHL	9 511 074
right	DHR	9 511 073



**Foot Pedal Double (Plastic)**

11mm Hex	7/16" Hex
KDH-9010/7037-30o	
KDH-9010/7037-45o	



**Foot Pedal Single**

Description	11mm Hex Hole EDP	7/16" Hex Hole EDP
left	04579	1 850 298
right	04580	1 850 297



**Foot Pedal Single (Plastic)**

11mm Hex	7/16" Hex
KEHL-9010/7037-30o	
KEHL-9010/7037-45o	

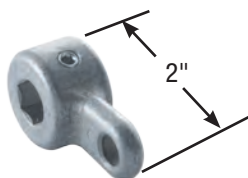

**Transmission Lever Short**

11mm Hex Hole EDP	7/16" Hex Hole EDP
MNK	09322



**Transmission Lever Long**

11mm Hex Hole EDP	7/16" Hex Hole EDP
MNL	09330 1.850.246

# PRIMACY TWIN WHEEL (PT)

FREE SWIVEL • TOTAL LOCK •  
TOTAL/DIRECTION LOCK COMBO

**NEW**

## APPLICATIONS

- Hospital Beds
- Stretchers
- Mobile Ultrasound Equipment
- OR Beds
- Radiology Tables
- Medical Chairs/Recliners
- ICU Beds
- Care Beds

## FEATURES

- Smooth integrated central locking selection for free swivel, total lock, and directional (steer) lock.
- Precision bearings in swivel section and sealed precision bearings in wheels.
- Durable twin non-marking polyurethane wheel treads
- High quality synthetic cover over die cast aluminum frame
- Antistatic Option Available
- Caster meets ISO Standard 22882: 2004 Caster & Wheels - Requirements for Casters for Hospital Beds.



PT-05PYP-283-TL-CL02

PT-06PYP-283-TL-CL01

## CENTRAL LOCKING TOTAL LOCK MODELS

Wheel Diameter mm (in)	Tread Width mm (in)	Wheel Description*	Capacity (Lbs)	Load Height mm (in)	Swivel Radius mm (in)	Wheel Bearing	Model Number
100 (4)	64 (2-1/2)	Polyurethane Gray	275	129 (5-5/64)	81 (3-1/4)	Precision Ball	PT-04PYP-283-TL-CL__
123 (5)	64 (2-1/2)	Polyurethane Gray	286	150 (5-29/32)	92.5 (3-41/64)	Precision Ball	PT-05PYP-283-TL-CL__
150 (6)	64 (2-1/2)	Polyurethane Gray	330	175 (6-29/32)	115 (4-17/32)	Precision Ball	PT-06PYP-283-TL-CL__

## CENTRAL LOCKING DIRECTIONAL AND TOTAL LOCK COMBO

100 (4)	64 (2-1/2)	Polyurethane Gray	275	129 (5-5/64)	81 (3-1/4)	Precision Ball	PT-04PYP-283-DT-CL__
123 (5)	64 (2-1/2)	Polyurethane Gray	286	150 (5-29/32)	92.5 (3-41/64)	Precision Ball	PT-05PYP-283-DT-CL__
150 (6)	64 (2-1/2)	Polyurethane Gray	330	175 (6-29/32)	115 (4-17/32)	Precision Ball	PT-06PYP-283-DT-CL__

## CENTRAL LOCKING FREE SWIVEL MODELS

100 (4)	64 (2-1/2)	Polyurethane Gray	275	129 (5-5/64)	81 (3-1/4)	Precision Ball	PT-04PYP-283-SW-RS__
123 (5)	64 (2-1/2)	Polyurethane Gray	286	150 (5-29/32)	92.5 (3-41/64)	Precision Ball	PT-05PYP-283-SW-RS__
150 (6)	64 (2-1/2)	Polyurethane Gray	330	175 (6-29/32)	115 (4-17/32)	Precision Ball	PT-06PYP-283-SW-RS__

\*For Antistatic caster models replace PYP in part number with APP.

### Locking Models

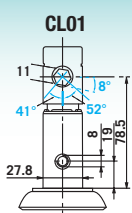

- Stem diameter 27.8mm
- Two locking hole options
- Locking hole in line or across direction of travel
- Four fixing holes
- Snap-on adapter sleeves options for different tube dimensions
- Standard cam (41°/52°)

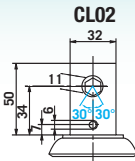

- Stem diameter 32mm
- Two locking hole options available
- Locking hole in line or across direction of travel
- Four fixing holes
- Standard cam 30°

Steering (locks swivel)

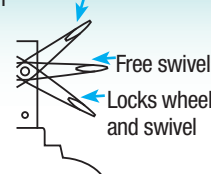

### Free Swivel Models



RS03  
27.8mm x 45mm  
for tubular frame  
with 28mm ID



RS05  
32mm x 45mm  
For tubular frame  
with 32mm ID

# MED-ULTRA (MU)

FREE SWIVEL • TOTAL LOCK • TOTAL/DIRECTION LOCK COMBO



**APPLICATIONS**

- Hospital Beds
- Stretchers
- Ultrasonic Equipment

**FEATURES**

- Precision bearings in wheels
- Caster meets ISO Standard 22882: 2004 Caster & Wheels - Requirements for Casters for Hospital Beds.
- Central-locking brake design has very Positive swivel lock - operates independently of the wheel brake, reducing wear and tendency to ratchet
- Wheel brake can be applied dynamically without damage to mechanism.
- Factory-set mechanism, maintenance-free for the life of the caster
- Stem with 4 x M8 fixing holes to suit all bed layouts and reduce stock holding.

Dual wheel design improves turning. Our new central locking brake design provides a more positive wheel lock with more surface contact on the wheel. Caster meets ISO Standard 22882: 2004 Casters & Wheels - Requirements for Casters for Hospital Beds.

Wheel Diameter Inches (mm)	Tread Width Inches (mm)	Wheel Description	Capacity (Lbs)	Load Height Inches (mm)	Swivel Lead Inches (mm)	Wheel Bearing	Model Number
<b>CENTRAL LOCKING TOTAL LOCK MODELS</b>							
5" (125)	2-1/2"(65)	Polyurethane Gray	352	6-1/64" (153)	1-37/64" (40)	Precision Ball	MU-05PYP-283-TL-____
5" (125)	2-1/2"(65)	Polyurethane Anti-Static	352	6-1/64" (153)	1-37/64" (40)	Precision Ball	MU-05APP-283-TL-____
6" (150)	3-5/32"(80)	Polyurethane Gray	484	7-1/16" (179)	1-25/32" (45)	Precision Ball	MU-06PYP-283-TL-____
6" (150)	3-5/32"(80)	Polyurethane Anti-Static	484	7-1/16" (179)	1-25/32" (45)	Precision Ball	MU-06APP-283-TL-____

## CENTRAL LOCKING DIRECTIONAL AND TOTAL LOCK COMBO

5" (127)	2-1/2"(65)	Polyurethane Gray	352	6-1/64" (153)	1-37/64" (40)	Precision Ball	MU-05PYP-283-DT-____
5" (127)	2-1/2"(65)	Polyurethane Anti-Static	352	6-1/64" (153)	1-37/64" (40)	Precision Ball	MU-05APP-283-DT-____
6" (150)	3-5/32"(80)	Polyurethane Gray	484	7-1/16" (179)	1-25/32" (45)	Precision Ball	MU-06PYP-283-DT-____
6" (150)	3-5/32"(80)	Polyurethane Anti-Static	484	7-1/16" (179)	1-25/32" (45)	Precision Ball	MU-06APP-283-DT-____

## FREE SWIVEL MODELS

5" (127)	2-1/2"(65)	Polyurethane Gray	352	6-1/64" (153)	1-37/64" (40)	Precision Ball	MU-05PYP-283-SW-____
5" (127)	2-1/2"(65)	Polyurethane Anti-Static	352	6-1/64" (153)	1-37/64" (40)	Precision Ball	MU-05APP-283-SW-____
6" (150)	3-5/32"(80)	Polyurethane Gray	484	7-1/16" (179)	1-25/32" (45)	Precision Ball	MU-06PYP-283-SW-____
6" (150)	3-5/32"(80)	Polyurethane Anti-Static	484	7-1/16" (179)	1-25/32" (45)	Precision Ball	MU-06APP-283-SW-____

### Locking Models

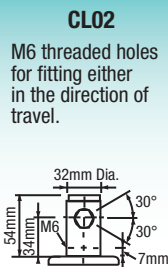
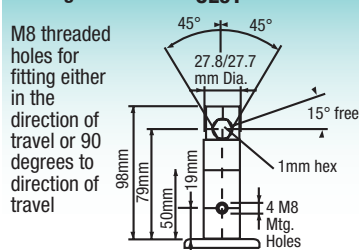

### Free Swivel Models

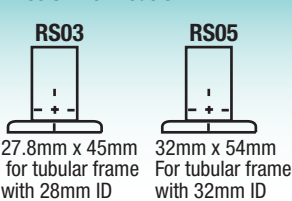

# TWIN TECH ULTRA (TU)

FREE SWIVEL • TOTAL LOCK •  
TOTAL/DIRECTION LOCK COMBO



## APPLICATIONS

- Hospital Beds
- Stretchers
- Ultrasonic Equipment

## FEATURES

- Improved braking system in swivel and wheel
- Precision bearings in wheels
- Caster meets ISO Standard 22882: 2004 Caster & Wheels - Requirements for Casters for Hospital Beds.
- Very Positive swivel lock - operates independently of the wheel brake, reducing wear and tendency to ratchet
- Wheel brake can be applied dynamically without damage to mechanism.
- Factory-set mechanism, maintenance-free for the life of the caster;
- Stem with 4 x M8 fixing holes to suit all bed layouts and reduce stock holding.

### CENTRAL LOCKING TOTAL LOCK MODELS

Wheel Diameter mm (in)	Tread Width mm (in)	Wheel Description	Capacity (lbs)	Load Height mm (in)	Swivel Radius mm (in)	Wheel Bearing	Model Number
125 (5)	65 (2-1/2)	Polyurethane Gray	297	138 (5-7/16)	105 (4-9/64)	Precision Ball	TU-05PYP-283-TL-CL

### CENTRAL LOCKING DIRECTIONAL AND TOTAL LOCK COMBO

125 (5)	65 (2-1/2)	Polyurethane Gray	297	138 (5-7/16)	105 (4-9/64)	Precision Ball	TU-05PYP-283-DT-CL
---------	------------	-------------------	-----	--------------	--------------	----------------	--------------------

### CENTRAL LOCKING FREE SWIVEL MODELS

125 (5)	65 (2-1/2)	Polyurethane Gray	297	138 (5-7/16)	105 (4-9/64)	Precision Ball	TU-05PYP-283-SW-RS
---------	------------	-------------------	-----	--------------	--------------	----------------	--------------------

#### Locking Models

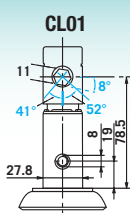

- Stem diameter 27.8mm
- Two locking hole options
- Locking hole in line or across direction of travel
- Four fixing holes
- Snap-on adapter sleeves options for different tube dimensions
- Standard cam (41°/52°)

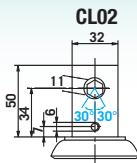

- Stem diameter 32mm
- Two locking hole options available
- Locking hole in line or across direction of travel
- Four fixing holes
- Standard cam 30°

Steering  
(locks swivel)

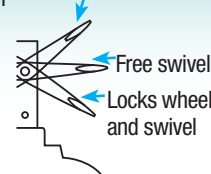

#### Free Swivel Models



RS03  
27.8mm x 45mm  
for tubular frame  
with 28mm ID



RS05  
32mm x 45mm  
For tubular frame  
with 32mm ID

# PRIMACY SINGLE WHEEL (PS)

FREE SWIVEL • TOTAL LOCK • TOTAL/DIRECTION LOCK COMBO

**NEW**



- APPLICATIONS**
- Hospital Beds
  - Stretchers
  - Mobile Ultrasound Equipment
  - OR Beds
  - Radiology Tables
  - Medical Chairs/Recliners
  - ICU Beds
  - Care Beds

- FEATURES**
- Smooth integrated central locking selection for free swivel, total lock, and directional (steer) lock.
  - Precision bearings in swivel section and sealed precision bearings in wheels.
  - Durable twin non-marking polyurethane wheel treads
  - High quality synthetic cover over die cast aluminum frame
  - Antistatic Option Available
  - Caster meets ISO Standard 22882: 2004 Caster & Wheels - Requirements for Casters for Hospital Beds.

## CENTRAL LOCKING TOTAL LOCK MODELS

Wheel Diameter mm (in)	Tread Width mm (in)	Wheel Description	Capacity (Lbs)	Load Height mm (in)	Swivel Radius mm (in)	Wheel Bearing	Model Number
125 (5)	32 (1-1/4)	Thermoplastic Rubber	264	158 (6-7/32)	102.5 (4-1/32)	Precision Ball	PS-05TPP-125-TL-CL__
125 (5)	32 (1-1/4)	Polyurethane	330	158 (6-7/32)	102.5 (4-1/32)	Precision Ball	PS-05PYP-125-TL-CL__
150 (6)	32 (1-1/4)	Thermoplastic Rubber	264	188 (7-13/32)	117 (4-39/64)	Precision Ball	PS-06TPP-125-TL-CL__
150 (6)	32 (1-1/4)	Polyurethane	330	188 (7-13/32)	117 (4-39/64)	Precision Ball	PS-06PYP-125-TL-CL__
200 (8)	32 (1-1/4)	Thermoplastic Rubber	264	229 (9)	156 (6-9/64)	Precision Ball	PS-08TPP-125-TL-CL__
200 (8)	32 (1-1/4)	Polyurethane	330	229 (9)	156 (6-9/64)	Precision Ball	PS-08PYP-125-TL-CL__

## CENTRAL LOCKING DIRECTIONAL AND TOTAL LOCK COMBO

125 (5)	32 (1-1/4)	Thermoplastic Rubber	264	158 (6-7/32)	102.5 (4-1/32)	Precision Ball	PS-05TPP-125-DT-CL__
125 (5)	32 (1-1/4)	Polyurethane	330	158 (6-7/32)	102.5 (4-1/32)	Precision Ball	PS-05PYP-125-DT-CL__
150 (6)	32 (1-1/4)	Thermoplastic Rubber	264	188 (7-13/32)	117 (4-39/64)	Precision Ball	PS-06TPP-125-DT-CL__
150 (6)	32 (1-1/4)	Polyurethane	330	188 (7-13/32)	117 (4-39/64)	Precision Ball	PS-06PYP-125-DT-CL__
200 (8)	32 (1-1/4)	Thermoplastic Rubber	264	229 (9)	156 (6-9/64)	Precision Ball	PS-08TPP-125-DT-CL__
200 (8)	32 (1-1/4)	Polyurethane	330	229 (9)	156 (6-9/64)	Precision Ball	PS-08PYP-125-DT-CL__

## CENTRAL LOCKING FREE SWIVEL MODELS

125 (5)	32 (1-1/4)	Thermoplastic Rubber	264	158 (6-7/32)	102.5 (4-1/32)	Precision Ball	PS-05TPP-125-SW-RS__
125 (5)	32 (1-1/4)	Polyurethane	330	158 (6-7/32)	102.5 (4-1/32)	Precision Ball	PS-05PYP-125-SW-RS__
150 (6)	32 (1-1/4)	Thermoplastic Rubber	264	188 (7-13/32)	117 (4-39/64)	Precision Ball	PS-06TPP-125-SW-RS__
150 (6)	32 (1-1/4)	Polyurethane	330	188 (7-13/32)	117 (4-39/64)	Precision Ball	PS-06PYP-125-SW-RS__
200 (8)	32 (1-1/4)	Thermoplastic Rubber	264	229 (9)	156 (6-9/64)	Precision Ball	PS-08TPP-125-SW-RS__
200 (8)	32 (1-1/4)	Polyurethane	330	229 (9)	156 (6-9/64)	Precision Ball	PS-08PYP-125-SW-RS__

### Locking Models

#### CL01

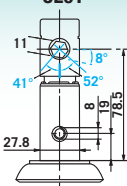

- Stem diameter 27.8mm
- Two locking hole options
- Locking hole in line or across direction of travel
- Four fixing holes
- Snap-on adapter sleeves options for different tube dimensions
- Standard cam (41°/52°)

#### CL02

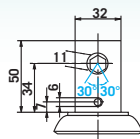

- Stem diameter 32mm
- Two locking hole options available
- Locking hole in line or across direction of travel
- Four fixing holes
- Standard cam 30°

### Steering (locks swivel)

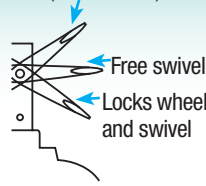

### Free Swivel Models

#### RS03

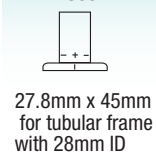

#### RS05

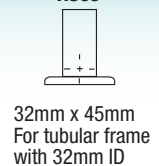

# PRIMACY COVER (PC)

FREE SWIVEL •  
TOTAL LOCK •  
TOTAL/DIRECTION  
LOCK COMBO

**NEW**



## APPLICATIONS

- Hospital Beds
- Stretchers
- Ultrasonic Equipment
- Care Beds
- Intensive Care Beds

## FEATURES

- Improved braking system in swivel and wheel
- Precision bearings in wheels
- TPR cover in one-piece design
- Caster meets ISO Standard 22882: 2004 Caster & Wheels - Requirements for Casters for Hospital Beds.
- Very Positive swivel lock that operates independently of the wheel brake, reducing wear and tendency to ratchet
- Wheel brake can be applied dynamically without damage to mechanism.
- Factory-set mechanism, maintenance-free for the life of the caster;
- Stem with M8 fixing holes to suit all bed layouts and reduce stock holding.

Antistatic option available. Consult Factory.

## CENTRAL LOCKING TOTAL LOCK MODELS

Wheel Diameter mm (in)	Tread Width mm (in)	Wheel Description	Capacity (Lbs)	Load Height mm (in)	Swivel Radius mm (in)	Wheel Bearing	Model Number
100 (4)	30 (1-1/4)	Thermoplastic Rubber	220	133 (5-8/32)	92 (3-5/16)	Precision Ball	PC-04TPP-125-TL-CL__
100 (4)	30 (1-1/4)	Polyurethane TPU	220	133 (5-8/32)	92 (3-5/16)	Precision Ball	PC-04PYP-125-TL-CL__
125 (5)	32 (1-1/4)	Thermoplastic Rubber	220	158 (6-3/16)	107 (4-3/16)	Precision Ball	PC-05TPP-125-TL-CL__
125 (5)	32 (1-1/4)	Polyurethane TPU	220	158 (6-3/16)	107 (4-3/16)	Precision Ball	PC-05PYP-125-TL-CL__
150 (6)	32 (1-1/4)	Thermoplastic Rubber	264	184 (7-1/4)	126 (4-15/16)	Precision Ball	PC-06TPP-125-TL-CL__
150 (6)	32 (1-1/4)	Polyurethane TPU	264	184 (7-1/4)	126 (4-15/16)	Precision Ball	PC-06PYP-125-TL-CL__
200 (8)	32 (1-1/4)	Thermoplastic Rubber	264	237 (9-5/16)	161 (6-5/16)	Precision Ball	PC-08TPP-125-TL-CL__
200 (8)	32 (1-1/4)	Polyurethane TPU	264	237 (9-5/16)	161 (6-5/16)	Precision Ball	PC-08PYP-125-TL-CL__

## CENTRAL LOCKING DIRECTIONAL AND TOTAL LOCK COMBO

100 (4)	30 (1-1/4)	Thermoplastic Rubber	220	133 (5-8/32)	92 (3-5/16)	Precision Ball	PC-04TPP-125-DT-CL__
100 (4)	30 (1-1/4)	Polyurethane TPU	220	133 (5-8/32)	92 (3-5/16)	Precision Ball	PC-04PYP-125-DT-CL__
125 (5)	32 (1-1/4)	Thermoplastic Rubber	220	158 (6-3/16)	107 (4-3/16)	Precision Ball	PC-05TPP-125-DT-CL__
125 (5)	32 (1-1/4)	Polyurethane TPU	220	158 (6-3/16)	107 (4-3/16)	Precision Ball	PC-05PYP-125-DT-CL__
150 (6)	32 (1-1/4)	Thermoplastic Rubber	264	184 (7-1/4)	126 (4-15/16)	Precision Ball	PC-06TPP-125-DT-CL__
150 (6)	32 (1-1/4)	Polyurethane TPU	264	184 (7-1/4)	126 (4-15/16)	Precision Ball	PC-06PYP-125-DT-CL__
200 (8)	32 (1-1/4)	Thermoplastic Rubber	264	237 (9-5/16)	161 (6-5/16)	Precision Ball	PC-08TPP-125-DT-CL__
200 (8)	32 (1-1/4)	Polyurethane TPU	264	237 (9-5/16)	161 (6-5/16)	Precision Ball	PC-08PYP-125-DT-CL__

## CENTRAL LOCKING FREE SWIVEL MODELS

100 (4)	30 (1-1/4)	Thermoplastic Rubber	220	133 (5-8/32)	92 (3-5/16)	Precision Ball	PC-04TPP-125-SW-RS__
100 (4)	30 (1-1/4)	Polyurethane TPU	220	133 (5-8/32)	92 (3-5/16)	Precision Ball	PC-04PYP-125-SW-RS__
125 (5)	32 (1-1/4)	Thermoplastic Rubber	220	158 (6-3/16)	107 (4-3/16)	Precision Ball	PC-05TPP-125-SW-RS__
125 (5)	32 (1-1/4)	Polyurethane TPU	220	158 (6-3/16)	107 (4-3/16)	Precision Ball	PC-05PYP-125-SW-RS__
150 (6)	32 (1-1/4)	Thermoplastic Rubber	264	184 (7-1/4)	126 (4-15/16)	Precision Ball	PC-06TPP-125-SW-RS__
150 (6)	32 (1-1/4)	Polyurethane TPU	264	184 (7-1/4)	126 (4-15/16)	Precision Ball	PC-06PYP-125-SW-RS__
200 (8)	32 (1-1/4)	Thermoplastic Rubber	264	237 (9-5/16)	161 (6-5/16)	Precision Ball	PC-08TPP-125-SW-RS__
200 (8)	32 (1-1/4)	Polyurethane TPU	264	237 (9-5/16)	161 (6-5/16)	Precision Ball	PC-08PYP-125-SW-RS__

### Locking Models

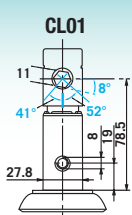

- Stem diameter 27.8mm
- Two locking hole options
- Locking hole in line or across direction of travel
- Four fixing holes
- Snap-on adapter sleeves options for different tube dimensions
- Standard cam (41°/52°)

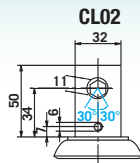

- Stem diameter 32mm
- Two locking hole options available
- Locking hole in line or across direction of travel
- Four fixing holes
- Standard cam 30°

Steering  
(locks swivel)

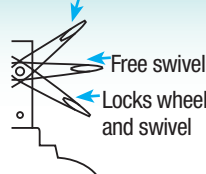

### Free Swivel Models



RS03  
27.8mm x 45mm  
for tubular frame  
with 28mm ID

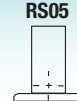

RS05  
32mm x 45mm  
For tubular frame  
with 32mm ID

# PRIMACY COVER PRECISION (PP)

FREE SWIVEL •  
TOTAL LOCK •  
TOTAL/DIRECTION  
LOCK COMBO

**NEW**



- APPLICATIONS**
- Hospital Beds
  - Stretchers
  - Ultrasonic Equipment
  - Care Beds
  - Intensive Care Beds

- FEATURES**
- Improved braking system in swivel and wheel
  - Precision bearings in wheels AND raceway
  - TPR cover in one-piece design
  - Caster meets ISO Standard 22882: 2004 Caster & Wheels - Requirements for Casters for Hospital Beds.
  - Very Positive swivel lock that operates independently of the wheel brake, reducing wear and tendency to ratchet
  - Wheel brake can be applied dynamically without damage to mechanism.
  - Factory-set mechanism, maintenance-free for the life of the caster;
  - Stem with M8 fixing holes to suit all bed layouts and reduce stock holding.

Antistatic option available. Consult Factory.

## CENTRAL LOCKING TOTAL LOCK MODELS

Wheel Diameter mm (in)	Tread Width mm (in)	Wheel Description	Capacity (Lbs)	Load Height mm (in)	Swivel Radius mm (in)	Wheel Bearing	Model Number
100 (4)	30 (1-1/4)	Thermoplastic Rubber	220	139 (5-15/32)	92 (3-5/16)	Precision Ball	PP-04TPP-125-TL-CL__
100 (4)	30 (1-1/4)	Polyurethane TPU	220	139 (5-15/32)	92 (3-5/16)	Precision Ball	PP-04PYP-125-TL-CL__
125 (5)	32 (1-1/4)	Thermoplastic Rubber	220	164 (6-7/16)	107 (4-3/16)	Precision Ball	PP-05TPP-125-TL-CL__
125 (5)	32 (1-1/4)	Polyurethane TPU	220	164 (6-7/16)	107 (4-3/16)	Precision Ball	PP-05PYP-125-TL-CL__
150 (6)	32 (1-1/4)	Thermoplastic Rubber	264	191 (7-1/2)	126 (4-15/16)	Precision Ball	PP-06TPP-125-TL-CL__
150 (6)	32 (1-1/4)	Polyurethane TPU	264	191 (7-1/2)	126 (4-15/16)	Precision Ball	PP-06PYP-125-TL-CL__
200 (8)	32 (1-1/4)	Thermoplastic Rubber	264	243 (9-9/16)	161 (6-5/16)	Precision Ball	PP-08TPP-125-TL-CL__
200 (8)	32 (1-1/4)	Polyurethane TPU	264	243 (9-9/16)	161 (6-5/16)	Precision Ball	PP-08PYP-125-TL-CL__

## CENTRAL LOCKING DIRECTIONAL AND TOTAL LOCK COMBO

100 (4)	30 (1-1/4)	Thermoplastic Rubber	220	139 (5-15/32)	92 (3-5/16)	Precision Ball	PP-04TPP-125-DT-CL__
100 (4)	30 (1-1/4)	Polyurethane TPU	220	139 (5-15/32)	92 (3-5/16)	Precision Ball	PP-04PYP-125-DT-CL__
125 (5)	32 (1-1/4)	Thermoplastic Rubber	220	164 (6-7/16)	107 (4-3/16)	Precision Ball	PP-05TPP-125-DT-CL__
125 (5)	32 (1-1/4)	Polyurethane TPU	220	164 (6-7/16)	107 (4-3/16)	Precision Ball	PP-05PYP-125-DT-CL__
150 (6)	32 (1-1/4)	Thermoplastic Rubber	264	191 (7-1/2)	126 (4-15/16)	Precision Ball	PP-06TPP-125-DT-CL__
150 (6)	32 (1-1/4)	Polyurethane TPU	264	191 (7-1/2)	126 (4-15/16)	Precision Ball	PP-06PYP-125-DT-CL__
200 (8)	32 (1-1/4)	Thermoplastic Rubber	264	243 (9-9/16)	161 (6-5/16)	Precision Ball	PP-08TPP-125-DT-CL__
200 (8)	32 (1-1/4)	Polyurethane TPU	264	243 (9-9/16)	161 (6-5/16)	Precision Ball	PP-08PYP-125-DT-CL__

## CENTRAL LOCKING FREE SWIVEL MODELS

100 (4)	30 (1-1/4)	Thermoplastic Rubber	220	139 (5-15/32)	92 (3-5/16)	Precision Ball	PP-04TPP-125-SW-RS__
100 (4)	30 (1-1/4)	Polyurethane TPU	220	139 (5-15/32)	92 (3-5/16)	Precision Ball	PP-04PYP-125-SW-RS__
125 (5)	32 (1-1/4)	Thermoplastic Rubber	220	164 (6-7/16)	107 (4-3/16)	Precision Ball	PP-05TPP-125-SW-RS__
125 (5)	32 (1-1/4)	Polyurethane TPU	220	164 (6-7/16)	107 (4-3/16)	Precision Ball	PP-05PYP-125-SW-RS__
150 (6)	32 (1-1/4)	Thermoplastic Rubber	264	191 (7-1/2)	126 (4-15/16)	Precision Ball	PP-06TPP-125-SW-RS__
150 (6)	32 (1-1/4)	Polyurethane TPU	264	191 (7-1/2)	126 (4-15/16)	Precision Ball	PP-06PYP-125-SW-RS__
200 (8)	32 (1-1/4)	Thermoplastic Rubber	264	243 (9-9/16)	161 (6-5/16)	Precision Ball	PP-08TPP-125-SW-RS__
200 (8)	32 (1-1/4)	Polyurethane TPU	264	243 (9-9/16)	161 (6-5/16)	Precision Ball	PP-08PYP-125-SW-RS__

### Locking Models

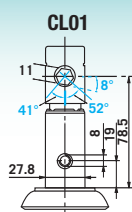

- Stem diameter 27.8mm
- Two locking hole options
- Locking hole in line or across direction of travel
- Four fixing holes
- Snap-on adapter sleeves options for different tube dimensions
- Standard cam (41°/52°)

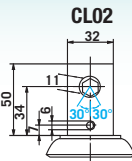

- Stem diameter 32mm
- Two locking hole options available
- Locking hole in line or across direction of travel
- Four fixing holes
- Standard cam 30°

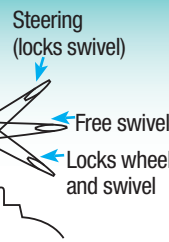

### Free Swivel Models



27.8mm x 45mm  
for tubular frame  
with 28mm ID



32mm x 45mm  
For tubular frame  
with 32mm ID

# MED-BED (MB)

FREE SWIVEL • TOTAL LOCK •  
TOTAL/DIRECTION LOCK COMBO



## APPLICATIONS

- Hospital Beds
- Stretchers

Anti-Microbial wheels available. Consult factory.

## FEATURES

- Wheels have full plastic thread guards
- Full double ball bearing raceways on 4" & 5" models
- Very Positive swivel lock—operates independently of the wheel brake, reducing wear and tendency to ratchet
- Precision ball bearings in wheels for easier rollability
- Wheels are crowned for easy rolling and turning
- Swivel rigs have a bright chrome finish
- Cam-hole orientation to customer specification - can be in direction of travel, or 90 degrees to direction of travel.
- Factory-set mechanism, maintenance-free for the life of the caster
- Stem with 4 x M8 fixing holes to suit all bed layouts and reduce extra inventory needs.

Our new central locking brake design provides a more positive wheel lock with more surface contact on the wheel. Caster meets ISO Standard 22882: 2004 Casters & Wheels - Requirements for Casters for Hospital Beds.

## CENTRAL LOCKING TOTAL LOCK

Wheel Diameter Inches (mm)	Tread Width (Inches)	Wheel Description	Capacity (Lbs)	Load Height Inches (mm)	Swivel Radius Inches (mm)	Wheel Bearing	Model Number
4" (100)	1-1/4	Thermoplastic Rubber	198	5-7/16" (138)	3-15/32" (88)	Precision Ball	MB-04TPP-125-TL-___
5" (125)	1-1/4	Thermoplastic Rubber	220	6-27/64"(163)	3-37/64" (91)	Precision Ball	MB-05TPP-125-TL-___

## CENTRAL LOCKING DIRECTIONAL AND TOTAL LOCK COMBO

4" (100)	1-1/4	Thermoplastic Rubber	198	5-7/16" (138)	3-15/32" (88)	Precision Ball	MB-04TPP-125-DT-___
5" (125)	1-1/4	Thermoplastic Rubber	220	6-27/64"(163)	3-37/64" (91)	Precision Ball	MB-05TPP-125-DT-___

## FREE SWIVEL MODELS

4" (100)	1-1/4	Thermoplastic Rubber	198	5-7/16" (138)	3-15/32" (88)	Precision Ball	MB-04TPP-125-SW-___
5" (125)	1-1/4	Thermoplastic Rubber	220	6-27/64"(163)	3-37/64" (91)	Precision Ball	MB-05TPP-125-SW-___

### Locking Models

M8 threaded holes for fitting either in the direction of travel or 90 degrees to direction of travel

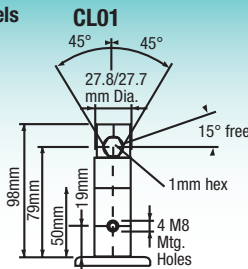

### CL02

M6 threaded holes for fitting either in the direction of travel.

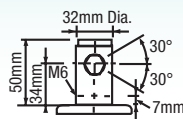

### Free Swivel Models

#### RS03

27.8mm x 45mm for tubular frame with 28mm ID

#### RS05

32mm x 54mm For tubular frame with 32mm ID



# HOSPITAL BED/STRETCHER REPLACEMENT WHEELS

**new**

## 35K THERMOPLASTIC RUBBER



- **Tread:** Grey TPE
- **Side:** Plastic Thread Guard
- **Hardness:** 80 (±5) Shore A

Wheel Diameter Inches (mm)	Tread Width Inches (mm)	Capacity (Lbs)	Bearing	Hub Width Inches (mm)	Bore Size Inches (mm)	Model Number
3.15" (80mm)	1-1/8" (30mm)	220	Precision Ball	1.44" (36.5mm)	5/16" (8mm)	35K080r
4" (100mm)	1-1/4" (32mm)	220	Precision Ball	1.44" (36.5mm)	5/16" (8mm)	35K100r
5" (125mm)	1-1/4" (32mm)	220	Precision Ball	1.44" (36.5mm)	5/16" (8mm)	35K125r
6" (150mm)	1-1/4" (32mm)	220	Precision Ball	1.44" (36.5mm)	5/16" (8mm)	35K150r
8" (200MM)	1-1/4" (32mm)	220	Precision Ball	1.44" (36.5mm)	5/16" (8mm)	35k200r

## 35K ELECTRICALLY CONDUCTIVE THERMOPLASTIC RUBBER



- **Tread:** Grey TPE
- **Side:** Plastic Thread Guard
- **Hardness:** 80 (±5) Shore A

Wheel Diameter Inches (mm)	Tread Width Inches (mm)	Capacity (Lbs)	Bearing	Hub Width Inches (mm)	Bore Size Inches (mm)	Model Number
3.15" (80mm)	1-1/8" (30mm)	220	Precision Ball	1.44" (36.5mm)	5/16" (8mm)	35K080A
4" (100mm)	1-1/4" (32mm)	220	Precision Ball	1.44" (36.5mm)	5/16" (8mm)	35K100A
5" (125mm)	1-1/4" (32mm)	220	Precision Ball	1.44" (36.5mm)	5/16" (8mm)	35K125A

## 35K THERMOPLASTIC POLYURETHANE



- **Tread:** Grey TPE
- **Side:** Plastic Thread Guard
- **Hardness:** 90 (±5) Shore A

Wheel Diameter Inches (mm)	Tread Width Inches (mm)	Capacity (Lbs)	Bearing	Hub Width Inches (mm)	Bore Size Inches (mm)	Model Number
4" (100mm)	1-1/4" (32mm)	220	Precision Ball	1.44" (36.5mm)	5/16" (8mm)	35K100V
5" (125mm)	1-1/4" (32mm)	220	Precision Ball	1.44" (36.5mm)	5/16" (8mm)	35K125V
6" (150mm)	1-1/4" (32mm)	220	Precision Ball	1.44" (36.5mm)	5/16" (8mm)	35K150V

## 32C NATURAL SOLID RUBBER



- **Tread:** Blue/grey natural solid rubber molded on stamped steel rim
- **Side:** Metal Thread Guard
- **Hardness:** 80 (±5) Shore A

Wheel Diameter Inches (mm)	Tread Width Inches (mm)	Capacity (Lbs)	Bearing	Hub Width Inches (mm)	Bore Size Inches (mm)	Model Number
3.15" (80mm)	1-1/8" (30mm)	160	Flanged Ball	1.46" (37mm)	5/16" (8mm)	32C080bz
4" (100mm)	1-1/4" (32mm)	160	Flanged Ball	1.46" (37mm)	5/16" (8mm)	32C100bz
5" (125mm)	1-1/4" (32mm)	200	Flanged Ball	1.46" (37mm)	5/16" (8mm)	32C125bz
6" (150mm)	1-1/4" (32mm)	220	Flanged Ball	1.46" (37mm)	5/16" (8mm)	32C150bz
8" (200MM)	1-1/4" (32mm)	240	Flanged Ball	1.46" (37mm)	5/16" (8mm)	32C200bz

## 32C ELECTRICALLY CONDUCTIVE NATURAL SOLID RUBBER



- **Tread:** Black natural solid rubber molded on stamped steel rim
- **Side:** Metal Thread Guard
- **Hardness:** 80 (±5) Shore A

Wheel Diameter Inches (mm)	Tread Width Inches (mm)	Capacity (Lbs)	Bearing	Hub Width Inches (mm)	Bore Size Inches (mm)	Model Number
3.15" (80mm)	1-1/8" (30mm)	160	Flanged Ball	1.46" (37mm)	5/16" (8mm)	32C080az
4" (100mm)	1-1/4" (32mm)	160	Flanged Ball	1.46" (37mm)	5/16" (8mm)	32C100az
5" (125mm)	1-1/4" (32mm)	200	Flanged Ball	1.46" (37mm)	5/16" (8mm)	32C125az
6" (150mm)	1-1/4" (32mm)	220	Flanged Ball	1.46" (37mm)	5/16" (8mm)	32c150az
8" (200MM)	1-1/4" (32mm)	240	Flanged Ball	1.46" (37mm)	5/16" (8mm)	32C200az

# WHEELS

## NEOTEQ (CN)



- **Tread:** Neoprene Rubber
- **Core:** Chrome Thread Guard
- **Temperature Range:** -30°F to +175°F
- **Hardness:** 65 (±5) Shore A

Wheel Diameter (Inches)	Tread Width (Inches)	Capacity (Lbs)	Bearing	Fits Axle Size (Inches)	Model Number
2	1	125	Precision Ball	5/16	CN-02NRP-100-05
2-1/2	1	160	Precision Ball	5/16	CN-25NRP-100-05
3	1	175	Precision Ball	5/16	CN-03NRP-100-05

## RAZER (RZ)



- **Tread:** TPR Grey Rubber
- **Side:** Metal Thread Guard
- **Temperature Range:** -30°F to +180°F
- **Hardness TP:** 85 (±5) Shore A
- **Hardness GR:** 75 (±5) Shore A

Wheel Diameter (Inches)	Tread Width (Inches)	Capacity (Lbs)	Bearing	Fits Axle Size (Inches)	Model Number
<b>TPR (TP)</b>					
<b>Grey Rubber (GR)</b>					
<b>New RZ Grey TPR (TP) Wheels</b>					
2	3/4	110	Plain	5/16	RZ-02TPN-070-05
3	7/8	140	Ball	5/16	RZ-03TPP-090-05
4	7/8	160	Ball	5/16	RZ-04TPP-090-05
5	7/8	165	Ball	5/16	RZ-05TPP-090-05
<b>New RZ Grey Rubber (GR) Wheels</b>					
2	3/4	110	Plain	5/16	RZ-02GRN-070-05
3	7/8	140	Ball	5/16	RZ-03GRP-090-05
4	7/8	160	Ball	5/16	RZ-04GRP-090-05
5	7/8	165	Ball	5/16	RZ-05GRP-090-05

## CHROME HOSPITAL (CH, CX)

### THERMOPLASTIC RUBBER



- **Tread:** TPR
- **Side:** Plastic Thread Guard
- **Temperature Range:** -30°F to +210°F
- **Hardness:** 85 (±5) Shore A

Wheel Diameter (Inches)	Tread Width (Inches)	Capacity (Lbs)	Bearing	Fits Axle Size (Inches)	Model Number
3	1-1/4	190	Precision Ball	5/16	CH-03TPP-125-05
4	1-1/4	240	Precision Ball	5/16	CH-04TPP-125-05
5	1-1/4	260	Precision Ball	5/16	CH-05TPP-125-05
6	1-1/4	260	Precision Ball	5/16	CH-06TPP-125-05

### ANTI-MICROBIAL TPR



- **Tread:** Anti-microbial TPR
- **Side:** Plastic Thread Guard
- **Temperature Range:** -30°F to +210°F
- **Hardness:** 85 (±5) Shore A

Wheel Diameter (Inches)	Tread Width (Inches)	Capacity (Lbs)	Bearing	Fits Axle Size (Inches)	Model Number
3	1-1/4	190	Precision Ball	5/16	CH-03AMP-125-05
4	1-1/4	240	Precision Ball	5/16	CH-04AMP-125-05
5	1-1/4	260	Precision Ball	5/16	CH-05AMP-125-05
6	1-1/4	260	Precision Ball	5/16	CH-06AMP-125-05

### NEOPRENE RUBBER



- **Tread:** Neoprene
- **Side:** Plastic Thread Guard
- **Temperature Range:** -30°F to +175°F
- **Hardness:** 64 (±5) Shore A

Wheel Diameter (mm)	Tread Width (Inches)	Capacity (Lbs)	Bearing	Fits Axle Size (Inches)	Model Number
100	1-1/4	250	Precision Ball	5/16	WO-04NRP-125-05
100	1-1/4	250	Precision Ball	3/8	WO-04NRP-125-06
125	1-1/4	300	Precision Ball	5/16	WO-05NRP-125-05
125	1-1/4	300	Precision Ball	3/8	WO-05NRP-125-06

### POLYURETHANE TPU



- **Tread:** TPR Polyurethane
- **Side:** Plastic Thread Guard
- **Temperature Range:** -30°F to +180°F
- **Hardness:** 95 (±5) Shore A

Wheel Diameter (Inches)	Tread Width (Inches)	Capacity (Lbs)	Bearing	Fits Axle Size (Inches)	Model Number
3	1-1/4	190	Precision Ball	5/16	CH-03PYP-125-05
4	1-1/4	240	Precision Ball	5/16	CH-04PYP-125-05
5	1-1/4	275	Precision Ball	5/16	CH-05PYP-125-05
6	1-1/4	300	Precision Ball	5/16	CH-06PYP-125-05

# WHEELS

## STAINLESS HOSPITAL (SX)

### THERMOPLASTIC RUBBER



- **Tread:** TPR
- **Bearing:** Precision Ball Stainless Steel
- **Side:** Plastic Thread Guard
- **Temperature Range:** -30°F to +210°F
- **Hardness:** 85 (±5) Shore A

Wheel Diameter (mm)	Tread Width (Inches)	Capacity (Lbs)	Bearing	Fits Axle Size (Inches)	Model Number
3	1-1/4	190	Precision Ball	5/16	SX-03TPX-125-05
4	1-1/4	240	Precision Ball	5/16	SX-04TPX-125-05
5	1-1/4	260	Precision Ball	5/16	SX-05TPX-125-05
6	1-1/4	260	Precision Ball	5/16	SX-06TPX-125-05

### POLYURETHANE TPU



- **Tread:** TPR Polyurethane
- **Bearing:** Precision Ball Stainless Steel
- **Side:** Plastic Thread Guard
- **Temperature Range:** -30°F to +180°F
- **Hardness:** 95 (±5) Shore A

Wheel Diameter (Inches)	Tread Width (Inches)	Capacity (Lbs)	Bearing	Fits Axle Size (Inches)	Model Number
3	1-1/4	190	Precision Ball	5/16	SX-03PYX-125-05
4	1-1/4	240	Precision Ball	5/16	SX-04PYX-125-05
5	1-1/4	275	Precision Ball	5/16	SX-05PYX-125-05
6	1-1/4	300	Precision Ball	5/16	SX-06PYX-125-05

## NYLON (NG) AND NYLON PLUS STAINLESS (NS)

### QUICKSTART TPR



- **Tread:** TPR
- **Side:** Integrated Thread Guard
- **Temperature Range:** -30°F to +180°F
- **Hardness:** 70 (±5) Shore A

Wheel Diameter (Inches)	Tread Width (Inches)	Capacity (Lbs)	Bearing	Fits Axle Size (Inches)	Model Number
3	1-1/4	200	Precision Ball	5/16	NG-03QDP-125-05
4	1-1/4	275	Precision Ball	5/16	NG-04QDP-125-05
5	1-1/4	325	Precision Ball	5/16	NG-05QDP-125-05
6	1-1/4	325	Precision Ball	5/16	NG-06QDP-125-05

### ANTI-MICROBIAL TPR



- **Tread:** Antimicrobial TPR
- **Side:** Integrated Thread Guard
- **Temperature Range:** -30°F to +180°F
- **Hardness:** 70 (±5) Shore A

Wheel Diameter (Inches)	Tread Width (Inches)	Capacity (Lbs)	Bearing	Fits Axle Size (Inches)	Model Number
3	1-1/4	200	Precision Ball	5/16	NG-03AMP-125-05
4	1-1/4	275	Precision Ball	5/16	NG-04AMP-125-05
5	1-1/4	325	Precision Ball	5/16	NG-05AMP-125-05
6	1-1/4	325	Precision Ball	5/16	NG-06AMP-125-05

## PLASTIC (PG)

### RUBBER ON PLASTIC



- **Tread:** Rubber/Santoprene
- **Side:** Integrated Thread Guard
- **Temperature Range:** -30°F to +210°F
- **Hardness:** 85 (±5) Shore A

Wheel Diameter (Inches)	Tread Width (Inches)	Capacity (Lbs)	Bearing	Fits Axle Size (Inches)	Model Number
4	1-1/4	220	Precision Ball	5/16	PG-04RPP-125-05
5	1-1/4	220	Precision Ball	5/16	PG-05RPP-125-05
6	1-1/4	264	Precision Ball	5/16	PG-06RPP-125-05
8	1-1/4	264	Precision Ball	5/16	PG-08RPP-125-05

## AC AUTOCLAVE (SS)

### DESIGNED FOR MOST AUTOCLAVE APPLICATIONS



- **Tread:** Hytrel
- Hytrel on autoclaveable PP
- **Temperature Range:** -30°F to +250°F
- **Hardness:** 92 (±5) Shore A

Wheel Diameter (mm)	Tread Width (Inches)	Capacity (Lbs)	Bearing*	Fits Axle Size (Inches)	Model Number
4	1-1/4	275	Precision Ball	3/8	SS-04HSP-125-06
5	1-1/4	300	Precision Ball	3/8	SS-05HSP-125-06
6	1-1/4	325	Precision Ball	3/8	SS-06HSP-125-06

\*SS precision ball bearings are stainless steel!

# WHEELS

## 2" TREAD WIDTH WHEELS

### SOLID URETHANE

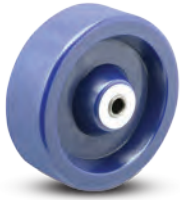

- **Tread:** High strength urethane compound
- **Steam cleanable**
- **Temperature Range:** -50°F to +180°F
- **Hardness:** 55 (±5) Shore D

Wheel Diameter (Inches)	Tread Width (Inches)	Capacity (Lbs)	Bearing	Fits Axle Size (Inches)	Model Number
4	2	700	Delrin	3/4	SS-04PYD-200-12
4	2	700	Roller	3/4	SS-04PYR-200-12
4	2	700	Precision Ball	3/4	SS-04PYP-200-12
5	2	1000	Delrin	3/4	SS-05PYD-200-12
5	2	1000	Roller	3/4	SS-05PYR-200-12
5	2	1000	Precision Ball	3/4	SS-05PYP-200-12
6	2	1200	Delrin	3/4	SS-06PYD-200-12
6	2	1200	Roller	3/4	SS-06PYR-200-12
6	2	1200	Precision Ball	3/4	SS-06PYP-200-12
8	2	1500	Delrin	3/4	SS-08PYD-200-12
8	2	1500	Roller	3/4	SS-08PYR-200-12
8	2	1500	Precision Ball	3/4	SS-08PYP-200-12

### MEDEAGLE



- **Tread:** Polyurethane
- **Temperature Range:** -40°F to +180°F
- **Hardness:** 90 (±5) Shore A

Wheel Diameter (Inches)	Tread Width (Inches)	Capacity (Lbs)	Bearing	Fits Axle Size (Inches)	Model Number
4	2	600	Delrin	3/4	SS-04EPD-200-12
4	2	600	Roller	3/4	SS-04EPR-200-12
4	2	600	Precision Ball	3/4	SS-04EPP-200-12
5	2	900	Delrin	3/4	SS-05EPD-200-12
5	2	900	Roller	3/4	SS-05EPR-200-12
5	2	900	Precision Ball	3/4	SS-05EPP-200-12
6	2	1100	Delrin	3/4	SS-06EPD-200-12
6	2	1100	Roller	3/4	SS-06EPR-200-12
6	2	1100	Precision Ball	3/4	SS-06EPP-200-12
8	2	1200	Delrin	3/4	SS-08EPD-200-12
8	2	1200	Roller	3/4	SS-08EPR-200-12
8	2	1200	Precision Ball	3/4	SS-08EPP-200-12

Note: Stainless and Delrin spanners available: SS= Stainless and SSD = Delrin  
 SS200 Spanner: 1/2" x 3/4" x 2-7/16" • SSD200 Spanner: 1/2" x 3/4" x 2-7/16"

### WHITE POLYOLEFIN



- **Tread:** Polyolefin
- **Temperature Range:** -20°F to +180°F
- **Hardness:** 65 (±5) Shore D

Wheel Diameter (Inches)	Tread Width (Inches)	Capacity (Lbs)	Bearing	Fits Axle Size (Inches)	Model Number
4	2	550	Delrin	3/4	SS-04PWD-200-12
4	2	550	Roller	3/4	SS-04PWR-200-12
4	2	550	Precision Ball	3/4	SS-04PWP-200-12
5	2	650	Delrin	3/4	SS-05PWD-200-12
5	2	650	Roller	3/4	SS-05PWR-200-12
5	2	650	Precision Ball	3/4	SS-05PWP-200-12
6	2	700	Delrin	3/4	SS-06PWD-200-12
6	2	700	Roller	3/4	SS-06PWR-200-12
6	2	700	Precision Ball	3/4	SS-06PWP-200-12
8	2	800	Delrin	3/4	SS-08PWD-200-12
8	2	800	Roller	3/4	SS-08PWR-200-12
8	2	800	Precision Ball	3/4	SS-08PWP-200-12



MedCaster is now the USA supplier of Rhombus Casters and Wheels! Rhombus Nimbus 399 Series casters combine aesthetics, quality, and functionality into a brilliant design. Not only is the Nimbus 399 quite possibly the most visually appealing healthcare caster ever created, it also meets the stringent requirements for medical equipment hygiene. Suitable for use in autoclaves, the Nimbus 399 Series features a die-cast aluminum, load-bearing housing and a highly polished, gently curved plastic cover in white or grey. Additional features include a precision ball bearing swivel head and an integrated selection mechanism with a central locking or directional locking brake. The innovative and elegant Nimbus 399 Series is designed to provide reliable performance and long service life under the rigorous demands of healthcare applications, including care beds, hospital beds, intensive care beds, medical equipment, operating tables, and operating beds. The Nimbus 399 Series is also available in an electrically conductive version. Other popular Rhombus casters supplied by MedCaster include Bariatric 389, 390 and 390+, 367 and 364 casters.

**367 &  
364**



Page 118-119

**BARIATRIC  
389**



Page 120-121

**390**



Page 122-123

**391**



Page 124-125

**NIMBUS  
399**



Page 126-127

**400 SERIES**



Consult MedCaster  
for details.

RHOMBUS



367 & 364

**APPLICATIONS**

- Care beds
- Medical-technical equipment
- Physical therapy equipment
- Rehab apparatus

**FEATURES**

- Stamped and drawn horn assembly
- Zinc-plated
- Double ball raceway that's sealed

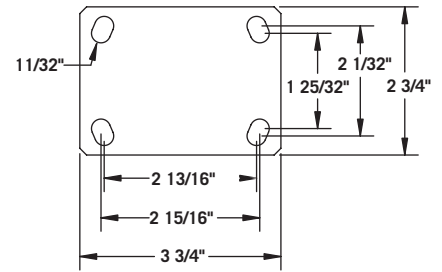
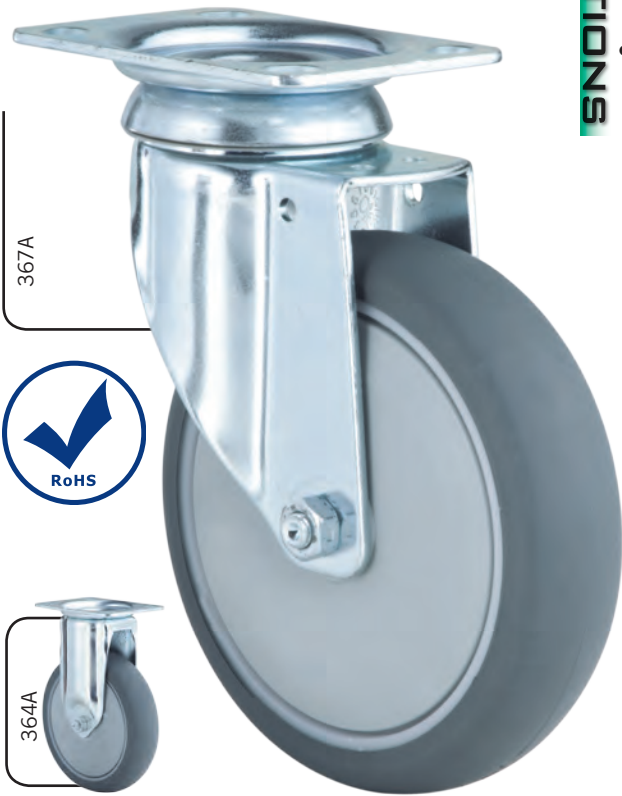

367 SERIES PF

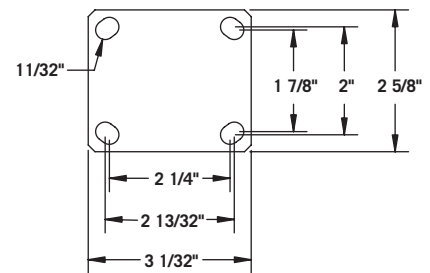
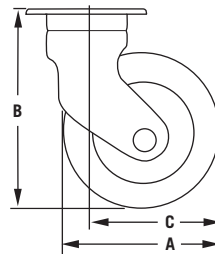

367 SERIES PD

**▼ DIMENSIONS**

**367/364 Series with Top Plate**

<b>A:</b> Wheel Diameter	3" (80mm)	4" (100mm)	5" (125mm)	6" (150mm)
<b>B:</b> Overall Height	4 1/2" (117mm)	5 1/4" (137mm)	6 1/2" (163mm)	7 1/2" (189mm)
<b>C:</b> Swivel Radius	3 1/4" (84mm)	3 1/2" (92mm)	3 1/4" (85mm)	4" (100mm)
<b>C:</b> Swivel Radius w/ brake	4" (100mm)	4 1/4" (106mm)	4 1/2" (110mm)	4 1/2" (110mm)

**▼ MOUNTING OPTIONS**



Hollow Kingpin  
LD: 12mm, LU: 1/2"



Expansion Stem\*



RHOMBUS



# 367 & 364

## ▼ SPECIFICATIONS

Wheel Diameter	Tread Width	Wheel Material	Wheel Bearing	Load Cap (lb)	Top Plate Caster	Top Plate EDP	Hollow Kingpin Caster	Hollow Kingpin EDP
3" (80mm)	1 1/4" (32mm)	TPR	Precision	220	364A35K080RZPF	07276		
3" (80mm)	1 1/4" (32mm)	TPR	Precision	220	367A35K080RZPF	07395	367A35K080RZLD	06304
3" (80mm)	1 1/4" (32mm)	TPR	Precision	220	367H35K080RZPF	08029	367H35K080RZLD	06245
3" (80mm)	1 1/4" (32mm)	TPR	Precision	220	367R35K080RZPF	06111		
4" (100mm)	1 1/4" (32mm)	TPR	Precision	220	364A35K100RZPF	07340		
4" (100mm)	1 1/4" (32mm)	TPR	Precision	220	367A35K100RZPF	07488	367A35K100RZLD	06307
4" (100mm)	1 1/4" (32mm)	TPR	Precision	220	367H35K100RZPF	07986	367H35K100RZLD	06306
4" (100mm)	1 1/4" (32mm)	TPR	Precision	220	367R35K100RZPF	06112		
5" (125mm)	1 1/4" (32mm)	TPR	Precision	220	364A35K125RZPF	07356		
5" (125mm)	1 1/4" (32mm)	TPR	Precision	220	367A35K125RZPF	07571	367A35K125RZLD	07571
5" (125mm)	1 1/4" (32mm)	TPR	Precision	220	367H35K125RZPF	08015	367H35K125RZLD	06309
5" (125mm)	1 1/4" (32mm)	TPR	Precision	220	367R35K125RZPF	06113		
6" (150mm)	1 1/4" (32mm)	TPR	Precision	220	364A35K150RZPF	07298		
6" (150mm)	1 1/4" (32mm)	TPR	Precision	220	367A35K150RZPF	07612	367A35K150RZLD	02109
6" (150mm)	1 1/4" (32mm)	TPR	Precision	220	367H35K150RZPF	08074	367H35K150RZLD	02113
6" (150mm)	1 1/4" (32mm)	TPR	Precision	220	367R35K150RZPF	06124		

The measurements in millimeters are exact.

↑  
To order 32C wheel change 35K to 32C.

## ▼ WHEEL OPTIONS

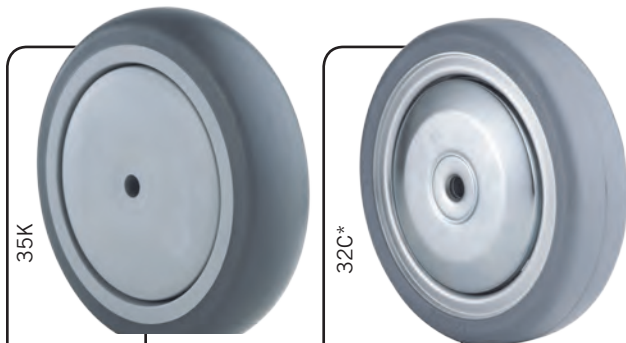

For grey rubber on metal disk change 35K to 32C

## ▼ LOCK OPTIONS

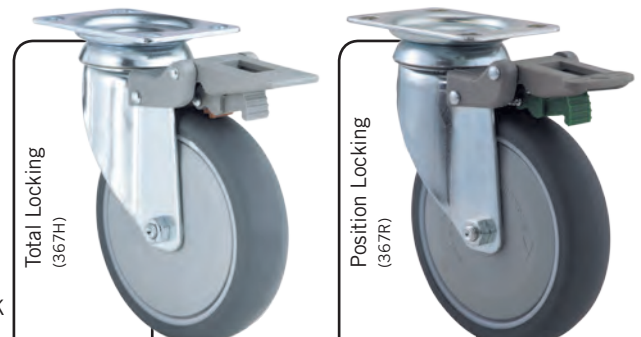

RHOMBUS



# BARIATRIC 389

## APPLICATIONS

- Mobile X-ray equipment
- Ultrasounds
- Large electrical medical equipment
- Bariatric hospital beds, chairs, tables

## FEATURES

- Double ball raceway
- Integrated selection mechanism with total locking brake "Q" and direction locking brake "R"
- Selection mechanism continually greased
- Compatible with other caster systems
- Powder-coated horn and wheel guard
- Zinc models available, consult factory



389Q  
(Swivel with Total Lock)  
389R  
(Swivel with Total and Position Lock)



385A

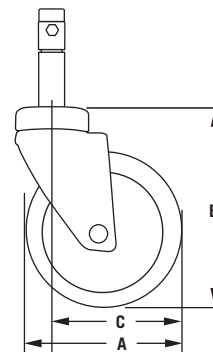

## ▼ DIMENSIONS

### 389/385 Series

<b>A:</b> Wheel Diameter	6 1/4" (160mm)	8" (200mm)
<b>B:</b> Overall Height	8" (200mm)	9 1/2" (245mm)
<b>C:</b> Swivel Radius	5" (125mm)	6 1/4" (158mm)

## ▼ PEDAL SETTINGS

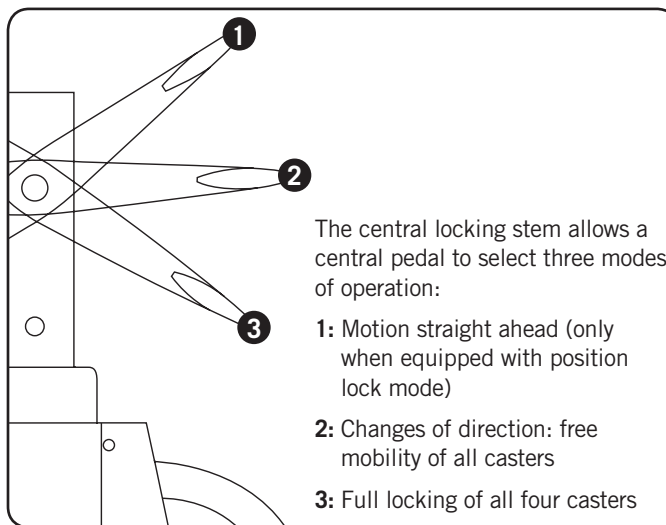



# RHOMBUS

## BARIATRIC 389

▼ SPECIFICATIONS

Wheel Diameter	Tread Width	Wheel Material	Wheel Bearing	Load Cap (lb)	Central Locking Caster	EDP
6 1/4" (160mm)	1 3/4" (45mm)	Polyurethane	Precision	550	385A43K160RP016	02003
6 1/4" (160mm)	1 3/4" (45mm)	Polyurethane	Precision	550	389R43K160RP016	02005
6 1/4" (160mm)	1 3/4" (45mm)	Polyurethane	Precision	550	389Q43K160RP016	02007
8" (200mm)	1 3/4" (45mm)	Polyurethane	Precision	600	385A43K200RP016	02004
8" (200mm)	1 3/4" (45mm)	Polyurethane	Precision	600	389R43K200RP016	02006
8" (200mm)	1 3/4" (45mm)	Polyurethane	Precision	600	389Q43K200RP016	02008

The measurements in inches are exact.

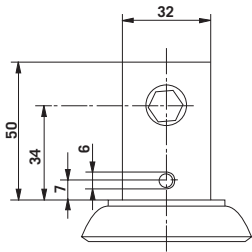

- Stem diameter 32mm
- Two locking hole options available
- Locking hole in line or across direction of travel
- Four fixing holes

▼ MOUNTING OPTIONS

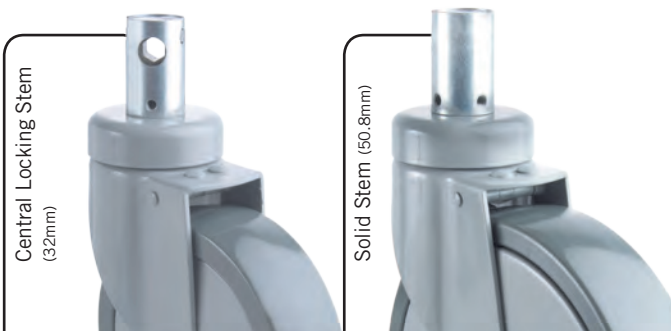

▼ WHEEL OPTIONS

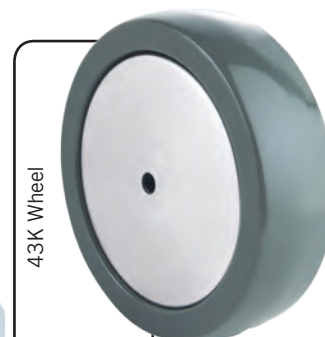

RHOMBUS



390



390Q  
(Swivel with Total Lock)  
390R  
(Swivel with Total and  
Position Lock)



**APPLICATIONS**

- Care beds
- Hospital beds
- Intensive care beds
- OR beds and tables
- Stretchers
- Gurneys

**FEATURES**

- Stamped and drawn horn assembly
- Zinc-plated
- Double ball raceway that's sealed
- Plastic seal protects from dust and water
- Integrated selection mechanism with total lock brake "Q" and position locking brake "R"
- Selection mechanism continually greased
- Brake adjustment feature is standard

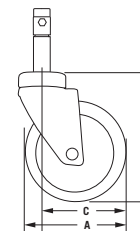

**▼ DIMENSIONS**

**390 Series**

<b>A:</b> Wheel Diameter	3" (80mm)	4" (100mm)	5" (125mm)
<b>B:</b> Overall Height	4 1/2" (113mm)	5 1/4" (133mm)	6 1/4" (158mm)
<b>C:</b> Swivel Radius	3 1/4" (84mm)	3 1/2" (92mm)	4 1/4" (107mm)
<b>A:</b> Wheel Diameter	6" (150mm)	8" (200mm)	
<b>B:</b> Overall Height	7 1/4" (184mm)	9 1/4" (237mm)	
<b>C:</b> Swivel Radius	5" (126mm)	6 1/4" (161mm)	

**▼ PEDAL SETTINGS**

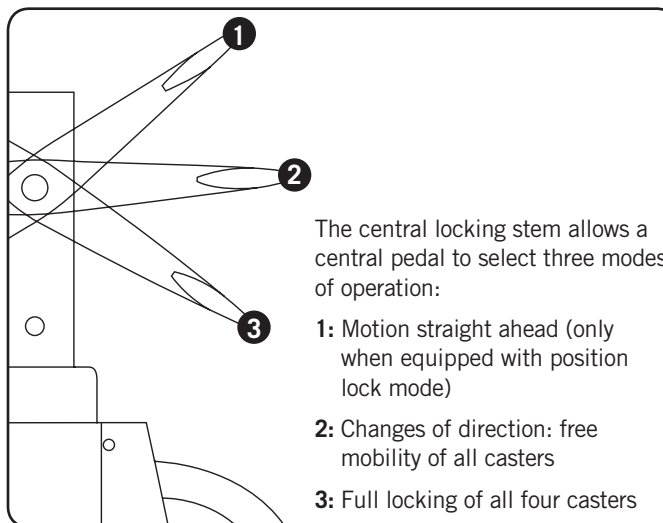

RHOMBUS



390

▼ SPECIFICATIONS

Wheel Diameter	Tread Width	Wheel Material	Wheel Bearing	Load Cap (lb)	Stem (78.5mm)	EDP	Stem (34mm)	EDP
3" (80mm)	1 1/4" (32mm)	TPR	Precision	220	390Q35K080RZ2351	06698	390Q35K080RZ985	02128
3" (80mm)	1 1/4" (32mm)	TPR	Precision	220	390R35K080RZ2351	02014	390R35K080RZ985	02132
4" (100mm)	1 1/4" (32mm)	TPR	Precision	220	390Q35K100RZ2351	02010	390Q35K100RZ985	02129
4" (100mm)	1 1/4" (32mm)	TPR	Precision	220	390R35K100RZ2351	02015	390R35K100RZ985	02133
5" (125mm)	1 1/4" (32mm)	TPR	Precision	220	390Q35K125RZ2351	06680	390Q35K125RZ985	06027
5" (125mm)	1 1/4" (32mm)	TPR	Precision	220	390R35K125RZ2351	06681	390R35K125RZ985	02134
6" (150mm)	1 1/4" (32mm)	TPR	Precision	220	390Q35K150RZ2351	02012	390Q35K150RZ985	02130
6" (150mm)	1 1/4" (32mm)	TPR	Precision	220	390R35K150RZ2351	02017	390R35K150RZ985	02135
8" (200mm)	1 1/4" (32mm)	TPR	Precision	220	390Q35K200RZ2351	02013	390Q35K200RZ985	02131
8" (200mm)	1 1/4" (32mm)	TPR	Precision	220	390R35K200RZ2351	02018	390R35K200RZ985	02136

The measurements in millimeters are exact.

↑  
To order 32C wheel change 35K to 32C.

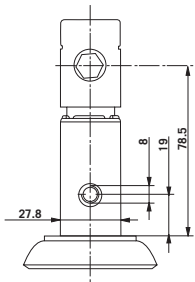

- Stem diameter 27.8mm
- Two locking hole options available
- Locking hole in line or across direction of travel
- Four fixing holes
- Snap-on adapter sleeves available for different tube dimensions

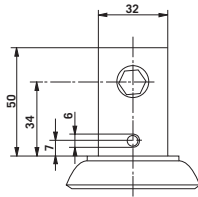

- Stem diameter 32mm
- Two locking hole options available
- Locking hole in line or across direction of travel
- Four fixing holes

▼ MOUNTING OPTIONS



▼ WHEEL OPTIONS

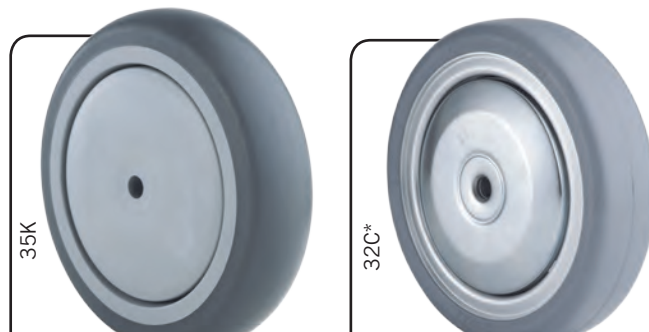

For grey rubber on metal disk change 35K to 32C

# RHOMBUS



## 391



### APPLICATIONS

- Care beds
- Hospital beds
- Intensive care beds
- OR beds and tables
- Stretchers
- Gurneys
- Ultrasonic Equipment

### FEATURES

- Improved braking system in swivel and wheel
- Precision bearings in raceway
- Precision bearings in 35K wheel; flange bearing in 32C wheel
- Caster meets ISO Standard 22882: 2004 Caster & Wheels - Requirements for Casters for Hospital Beds
- New central-locking brake design has: Very Positive swivel lock - operates independently of the wheel brake, reducing wear and tendency to ratchet
- Wheel brake can be applied dynamically without damage to mechanism
- Factory-set mechanism, maintenance-free for the life of the caster
- Stem with M8 fixing holes to suit all bed layouts and reduce stock holding

### ▼ PEDAL SETTINGS

The central locking stem allows a central pedal to select three modes of operation:

- 1:** Motion straight ahead (only when equipped with position lock mode)
- 2:** Changes of direction: free mobility of all casters
- 3:** Full locking of all four casters

### ▼ WHEEL OPTIONS



35K TPR  
(in chart at right)



35K Electrically Conductive TPR  
(To order change R to A)



32C Natural rubber on steel rim  
(in chart at right)



32C Electrically conductive natural rubber on steel rim  
(To order change B to A)



# 391

Wheel Diameter Inches (mm)	Tread Width Inches (mm)	Wheel Description	Capacity (Lbs)	Load Height Inches (mm)	Swivel Radius Inches (mm)	Wheel Bearing	Model Number
<b>CENTRAL LOCKING TOTAL LOCK MODELS</b>							
4	1-1/4"/32	35K TPR	220	5-1/2"/139	3-11/16"/92	Precision Ball	391Q 35K 100 RZ
4	1-1/4"/32	32C Rubber on steel	220	5-1/2"/139	3-11/16"/92	Flange Bearing	391Q 32C 100 BZ
5	1-1/4"/32	35K TPR	220	6-7/16"/164	4-7/16"/107	Precision Ball	391Q 35K 125 RZ
5	1-1/4"/32	32C Rubber on steel	220	6-7/16"/164	4-7/16"/107	Flange Bearing	391Q 32C 125 BZ
6	1-1/4"/32	35K TPR	264	7-1/2"/191	4-15/16"/126	Precision Ball	391Q 35K 150 RZ
6	1-1/4"/32	32C Rubber on steel	264	7-1/2"/191	4-15/16"/126	Flange Bearing	391Q 32C 150 BZ
8	1-1/4"/32	35K TPR	264	9-9/16"/243	6-5/16"/161	Precision Ball	391Q 35K 200 RZ
8	1-1/4"/32	32C Rubber on steel	264	9-9/16"/243	6-5/16"/161	Flange Bearing	391Q 32C 200 BZ

<b>CENTRAL LOCKING DIRECTIONAL AND TOTAL LOCK COMBO</b>							
4	1-1/4"/32	35K TPR	220	5-1/2"/139	3-11/16"/92	Precision Ball	391R 35K 100 RZ
4	1-1/4"/32	32C Rubber on steel	220	5-1/2"/139	3-11/16"/92	Flange Bearing	391R 32C 100 BZ
5	1-1/4"/32	35K TPR	220	6-7/16"/164	4-7/16"/107	Precision Ball	391R 35K 125 RZ
5	1-1/4"/32	32C Rubber on steel	220	6-7/16"/164	4-7/16"/107	Flange Bearing	391R 32C 125 BZ
6	1-1/4"/32	35K TPR	264	7-1/2"/191	4-15/16"/126	Precision Ball	391R 35K 150 RZ
6	1-1/4"/32	32C Rubber on steel	264	7-1/2"/191	4-15/16"/126	Flange Bearing	391R 32C 150 BZ
8	1-1/4"/32	35K TPR	264	9-9/16"/243	6-5/16"/161	Precision Ball	391R 35K 200 RZ
8	1-1/4"/32	32C Rubber on steel	264	9-9/16"/243	6-5/16"/161	Flange Bearing	391R 32C 200 BZ

<b>CENTRAL LOCKING FREE SWIVEL MODELS</b>							
4	1-1/4"/32	35K TPR	220	5-1/2"/139	3-11/16"/92	Precision Ball	391A 35K 100 RZ
4	1-1/4"/32	32C Rubber on steel	220	5-1/2"/139	3-11/16"/92	Flange Bearing	391A 32C 100 BZ
5	1-1/4"/32	35K TPR	220	6-7/16"/164	4-7/16"/107	Precision Ball	391A 35K 125 RZ
5	1-1/4"/32	32C Rubber on steel	220	6-7/16"/164	4-7/16"/107	Flange Bearing	391A 32C 125 BZ
6	1-1/4"/32	35K TPR	264	7-1/2"/191	4-15/16"/126	Precision Ball	391A 35K 150 RZ
6	1-1/4"/32	32C Rubber on steel	264	7-1/2"/191	4-15/16"/126	Flange Bearing	391A 32C 150 BZ
8	1-1/4"/32	35K TPR	264	9-9/16"/243	6-5/16"/161	Precision Ball	391A 35K 200 RZ
8	1-1/4"/32	32C Rubber on steel	264	9-9/16"/243	6-5/16"/161	Flange Bearing	391A 32C 200 BZ

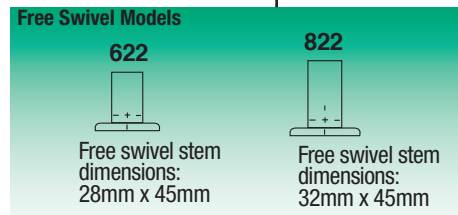
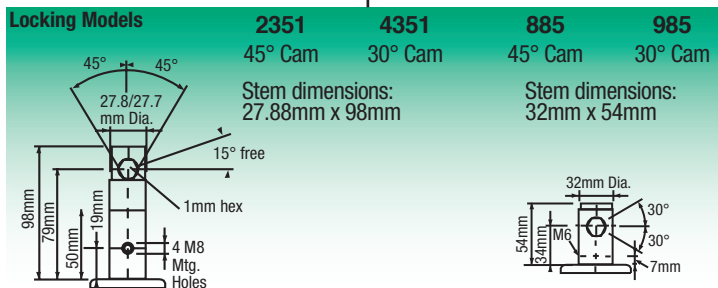

Central locking mechanism includes: Two locking hole options available • Locking hole in line or across direction of travel • Four M8 fixing holes • Snap-on adapter sleeves available for different tube dimensions

RHOMBUS



NIMBUS 399

APPLICATIONS

- Care beds
- Hospital beds
- Intensive care beds
- Medical appliances
- OR beds
- OR tables
- Stretches
- Gurneys

FEATURES

- Die-cast aluminum load-bearing housing
- Highly polished plastic cover in white RAL 9016 or metallic
- Unique design and patented technology
- Precision ball bearings in the raceway
- Autoclave safe
- Smooth selection function
- Integrated selection mechanism with total locking brake "Q" and position locking brake "R"
- Load capacity 330 lb



399Q (Swivel with Total Lock)  
399R (Swivel with Total and Position Lock)



Available in Grey\*

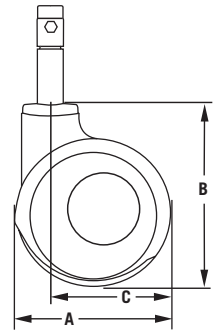

▼ DIMENSIONS

399 Series

A: Wheel Diameter	6" (150mm)
B: Overall Height	7 1/2" (188mm)
C: Swivel Radius	4 1/2" (117mm)

▼ PEDAL SETTINGS

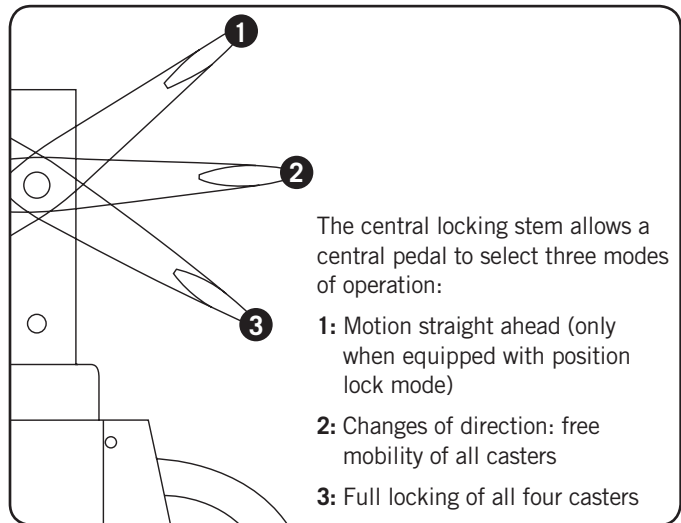

▼ AWARDS



reddot design award  
winner 2006



# RHOMBUS

## NIMBUS 399

### ▼ SPECIFICATIONS

Wheel Diameter	Tread Width	Wheel Material	Wheel Bearing	Load Cap (lb)	Stem (78.5mm)	EDP	Stem (34mm)	EDP
6" (150mm)	1 1/4" (32mm)	Polyurethane	Precision	330	399Q38K150VK2351	02027	399Q38K150VK985	02144
6" (150mm)	1 1/4" (32mm)	Polyurethane	Precision	330	399R38K150VK2351	02028	399R38K150VK985	02145

The measurements in millimeters are exact.

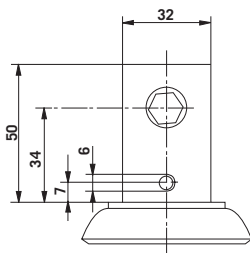

- Stem diameter 32mm
- Two locking hole options available
- Locking hole in line or across direction of travel
- Four fixing holes

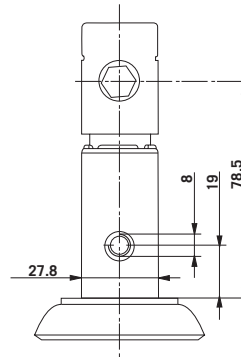

- Stem diameter 27.8mm
- Two locking hole options available
- Locking hole in line or across direction of travel
- Four fixing holes
- Snap-on adapter sleeves available for different tube dimensions

### ▼ MOUNTING OPTIONS



# PREVAIL LOW PROFILE TWIN WHEEL (PL)

FREE SWIVEL • TOTAL LOCK • TOTAL/DIRECTION LOCK COMBO

**NEW**



## APPLICATIONS

- Hospital Beds
- Stretchers
- Mobile Ultrasound Equipment
- Radiology Tables
- Medical Chairs/Recliners
- ICU Beds
- Care Beds

## FEATURES

- Smooth Integrated Central Locking Selection for free Swivel, Total Lock, and Directional (steer) Lock
- Precision Bearings in Swivel Section and Sealed Precision Bearings in wheels.
- Durable Twin Non-marking Polyurethane wheel treads
- Washable - Easy to clean and Disinfect with detergents and cleaning agents
- Antistatic Option Available
- TUV Certified
- Caster meets ISO Standard 22882 - EN 12531 Caster & Wheels - Requirements for Casters for Hospital Beds

## CENTRAL LOCKING TOTAL LOCK MODELS

Wheel Diameter mm (in)	Tread Width mm (in)	Wheel Description*	Capacity (lbs)	Load Height mm (in)	Swivel Radius mm (in)	Wheel Bearing	Model Number
125 (4-21/25)	2X 15mm	Polyurethane Grey	330	145 (5-7/10)	100.5 (3-61/64)	Double Precision Ball	PL-05PYP-283-TL-CL__
150 (5-9/10)	2X 15mm	Polyurethane Grey	330	165 (6-1/2)	120 (4-3/4)	Double Precision Ball	PL-06PYP-283-TL-CL__

## CENTRAL LOCKING DIRECTIONAL AND TOTAL LOCK COMBO

125 (4-21/25)	2X 15mm	Polyurethane Grey	330	145 (5-7/10)	100.5 (3-61/64)	Double Precision Ball	PL-05PYP-283-DT-CL__
150 (5-9/10)	2X 15mm	Polyurethane Grey	330	165 (6-1/2)	120 (4-3/4)	Double Precision Ball	PL-06PYP-283-DT-CL__

## FREE SWIVEL MODELS

125 (4-21/25)	2X 15mm	Polyurethane Grey	330	145 (5-7/10)	100.5 (3-61/64)	Double Precision Ball	PL-05PYP-283-SW-CL__
150 (5-9/10)	2X 15mm	Polyurethane Grey	330	165 (6-1/2)	120 (4-3/4)	Double Precision Ball	PL-06PYP-283-SW-CL__

\*For Antistatic caster models replace PYP in part number with APP.

### Locking Models

M8 threaded holes for fitting either in the direction of travel or 90 degrees to direction of travel

### Free Swivel Models

**RS03**



27.8mm x 45mm for tubular frame with 28mm ID

**RS05**



32mm x 45mm For tubular frame with 32mm ID

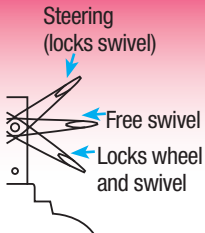

### CL01

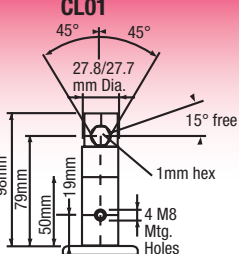

### CL02

M6 threaded holes for fitting either in the direction of travel.

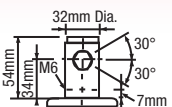



# BUMPERS



**End Bumper EB-1**

Grey end bumper generally used on the ends of tubular handles; 3-1/4" diameter with steel insert for 5/16" bolt.



**Corner Bumper CB-8**

Grey corner bumper for mounting on flat surfaces. 7/8" thick x 1" high x 2-5/8" long from inside corner.



**Corner Bumper CB-10**

Grey corner bumper for mounting on flat surfaces; ends of legs are tapered, with steel inserts. 1" thick x 1-1/16" high x 3-1/16" long from inside corner.



**Corner Bumper CB-12**

Grey corner bumper for mounting on flat surfaces; ends of legs may be cut at notched area to make square ends, with steel inserts. 7/8" thick x 1" high x 3-1/8" long from inside corner.



**Tubing Bumper B-3-1/2**

3-1/2" diameter bumper fits 1" O.D. round (TB3.5R) or square (TB3.5S) tubing



**Rolling Bumper RB-5 & RB-7**

5" and 7" diameter rolling bumpers; tapered grey rubber bonded to a zinc-plated insert with removable center bushings to fit diameters from 3/8" to 1-1/8"

# CASTER SOCKETS AND HARDWARE

**NEW**

## CASTER SOCKETS (ROUND & SQUARE)

Model Number	Tube Size	Tube ID	Socket Size	Grip Ring Size	Description
SCKT92	Round 1" x 16 gauge	.870"	.887" diameter	7/16"	Black nylon 2-5/16" long
SCKT94	Round 1" x 18 gauge	.902"	.912" diameter	7/16"	Black nylon 2-5/16" long
SCKT96	Round 1-1/4" x 16 gauge	1.120"	1.140" diameter	7/16"	Black nylon 2-5/16" long
SCKT22	Square 1-1/2" x 7 gauge	1.140"	1.154" square	7/16"	Brown nylon 2-1/4" long
SCKT18	Square 1" x 18 gauge	.902"	.916" square	7/16"	Black nylon 2-5/16" long



## BUSHINGS



Model Number	Description
SSBushing	5/16" x 3/8" x 1-15/32" stainless bushing
CHSPM10	1/2" to M10 reducer busing for CH series HK01



## GRIP RING STEM KITS (RZ)

Model Number	Description
RZGR01	7/16" x 7/8" grip ring stem with nut
RZGR02	7/16" x 1-7/16" grip ring stem kit with nut

Note above kits can only be added to 3" and larger Razer (RZ) HK04 casters.

## AXLES

Model Number	Description
CHAXLE	5/16" axle and nut for (CH) 1-1/4" wide series
SSAXLE	Stainless steel 5/16" axle and nut for (SS) 1-1/4" wide series

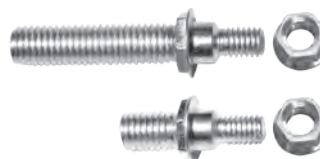

## THREADED STEM KITS (CH)

Model Number	Description
CHTS01	1/2"-13 x 3/4" threaded stem kit with nut
CHTS02	1/2"-13 x 1" threaded stem kit with lock nut (CH Series)
CHTS03	1/2"-13 x 1-1/2" threaded stem kit with lock nut (CH Series)
CHTS04	1/2"-13 x 2" threaded stem kit with nut (CH Series)

Note: Above kits can only be added to CH HK01 casters.

## THREADED STEM KITS (RZ)

Model Number	Description
RZTS06	3/8"-16 x 1" threaded stem kit with nut
RZTS25	3/6"-16 x 1-1/2" threaded stem kit with nut
RZTS15	M10 x 15mm threaded stem kits with nut

Note: Above kits can only be added to 3" and larger Razer (RZ) HK04 casters.

# SPECIALTY/CONVERSION

## SPECIALTY PRODUCTS



SA Spring Loaded Casters



Specialty Dual Wheel Casters

MedCaster has a complete line of casters and wheels for the medical industry ... yet, sometimes you may need a unique solution for a caster or wheel that you cannot find. Contact us with your requirements.

## INCHES TO MILLIMETERS CONVERSION

Inches (Fraction)	Inches (Decimal)	Millimeters	Inches (Fraction)	Inches (Decimal)	Millimeters	Inches (Fraction)	Inches (Decimal)	Millimeters
1/64	0.02	0.40	1/2	0.50	12.69	1	1.00	25.38
1/32	0.03	0.79	33/64	0.52	13.09	2	2.00	50.76
3/64	0.05	1.19	17/32	0.53	13.48	3	3.00	76.14
1/16	0.06	1.59	35/64	0.55	13.88	4	4.00	101.52
5/64	0.08	1.98	9/16	0.56	14.28	5	5.00	126.90
3/32	0.09	2.38	37/64	0.58	14.67	6	6.00	152.28
7/64	0.11	2.78	19/32	0.59	15.07	7	7.00	177.66
1/8	0.13	3.17	39/64	0.61	15.47	8	8.00	203.05
9/64	0.14	3.57	5/8	0.63	15.86	12	12.00	304.57
5/32	0.16	3.97	41/64	0.64	16.26			
11/64	0.17	4.36	21/32	0.66	16.66			
3/16	0.19	4.76	43/64	0.67	17.05			
13/64	0.20	5.16	11/16	0.69	17.45			
7/32	0.22	5.55	45/64	0.70	17.85			
15/64	0.23	5.95	23/32	0.72	18.24			
1/4	0.25	6.35	47/64	0.73	18.64			
17/64	0.27	6.74	3/4	0.75	19.04			
9/32	0.28	7.14	49/64	0.77	19.43			
19/64	0.30	7.53	25/32	0.78	19.83			
5/16	0.31	7.93	51/64	0.80	20.23			
21/64	0.33	8.33	13/16	0.81	20.62			
11/32	0.34	8.72	53/64	0.83	21.02			
23/64	0.36	9.12	27/32	0.84	21.41			
3/8	0.38	9.52	55/64	0.86	21.81			
25/64	0.39	9.91	7/8	0.88	22.21			
13/32	0.41	10.31	57/64	0.89	22.60			
27/64	0.42	10.71	29/32	0.91	23.00			
7/16	0.44	11.10	59/64	0.92	23.40			
29/64	0.45	11.50	15/16	0.94	23.79			
15/32	0.47	11.90	61/64	0.95	24.19			
31/64	0.48	12.29	31/32	0.97	24.59			
			63/64	0.98	24.98			

- **Convert Inches to Millimeters:**  
Divide by .0394 (note: this is how above chart was calculated and rounded to hundredths)
- **Convert Millimeters to Inches:**  
Multiply by .0394.
- **Convert Kilograms to Pounds:**  
Multiply by 2.2046.
- **Convert Pounds to Kilograms:**  
Divide by 2.2046.

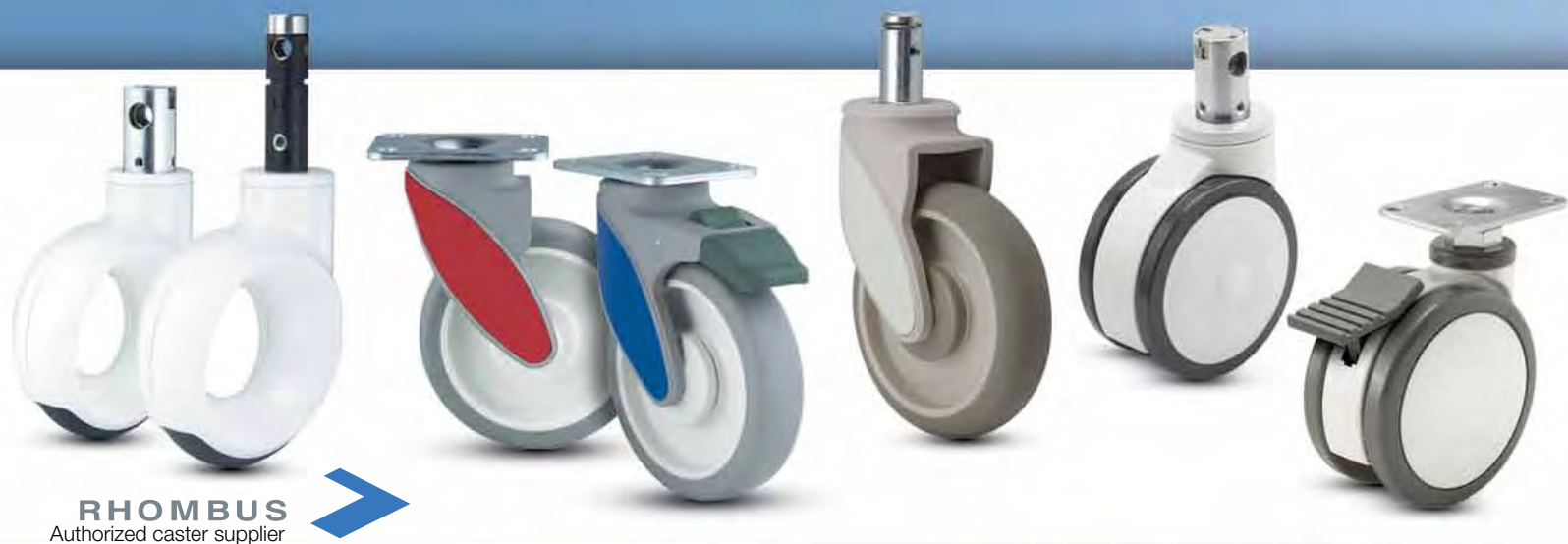

**RHOMBUS**  
Authorized caster supplier



Distributed by: B&C Industrial Products, Inc.



Phone: 1-888-276-3386

Email: [sales@bandcip.com](mailto:sales@bandcip.com)

**MedCaster™**

All specifications and dimensions are accurate for present manufacture but subject to change without notice.

©2012 MedCaster

