

SECTION A-A
F97 CHANNEL, 3-1/2" x 1-1/2" x 12ga

SPECIFICATIONS

BETWEEN FRAMES: 6" - 51"	LENGTH: 18" - 120"
ROLLER CENTERS: 2.25", 3", 4.5", 6", 9", 12"	
ROLLERS: 1909 Roller - 9ga wall tube. 1912 Roller - 12ga wall tube. 1916 Roller - 16ga wall tube. All rollers 1.9" dia., with 7/16" hex cold rolled steel axles, spring retained. Standard bearings are light oil lubricated. Optional bearings include combinations of precision, semi-precision, and non-precision construction with light oil or grease packed lubrication.	
FRAMES: Standard F97 set high 3-1/2" x 1-1/2" x 12ga formed steel channel with bolted 2" x 8ga galvanized angle crossies.	
ROLL COVERS: <u>Optional</u> Orange Polyurethane, 1/8" wall or galvanized tube for 1912, 1916.	
COUPLINGS: Bolted butt couplers <u>standard</u> on both ends of channel.	
FRAME FINISH: Standard finish is OSHA safety blue powder. <u>Optional</u> colors include green, beige, gray, orange, black and yellow.	

Model: 1909 - Gravity Roller Conveyor, 1.9 diameter 9 gauge roller
 1912 - Gravity Roller Conveyor, 1.9 diameter 12 gauge roller
 1916 - Gravity Roller Conveyor, 1.9 diameter 16 gauge roller

REV
0



FRAME OPTIONS:

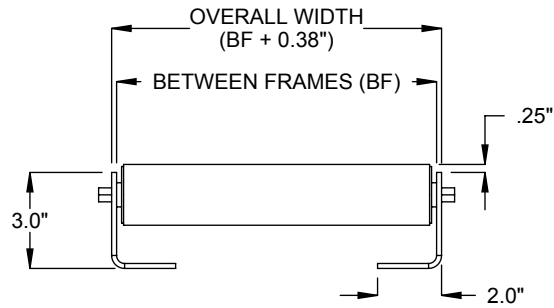

F06 ANGLE, 3" x 2" x 12ga
TOED IN

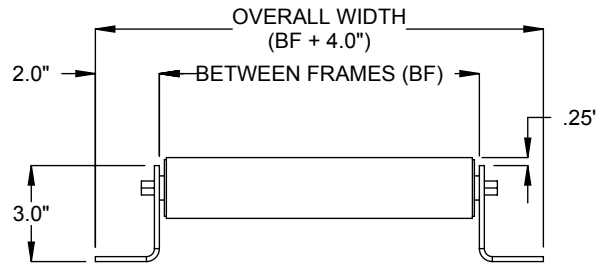

F07 ANGLE, 3" x 2" x 8ga
TOED OUT
1909, 1912 ONLY

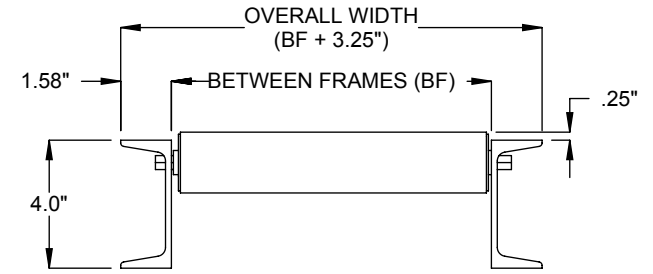

F15 CHANNEL, 4@5.4#

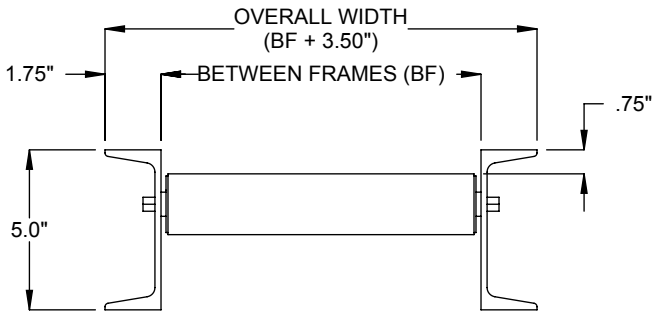

F16 CHANNEL, 5@6.7#

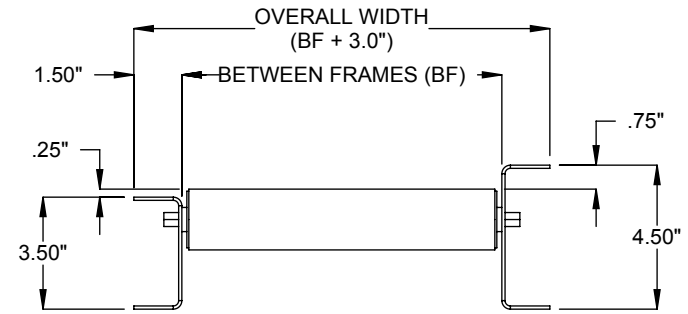

F18 CHANNEL, 3-1/2" & 4-1/2"

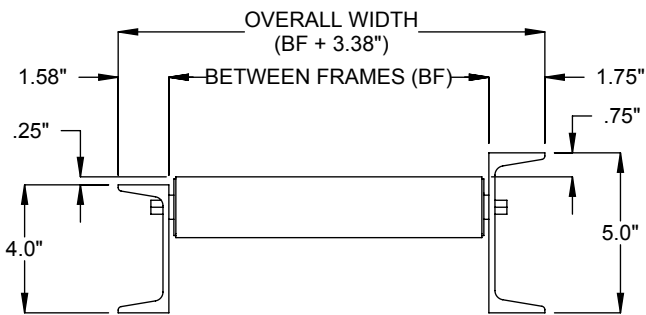

F20 CHANNEL, 5@6.7# & 4@5.4#
1909, 1912 ONLY

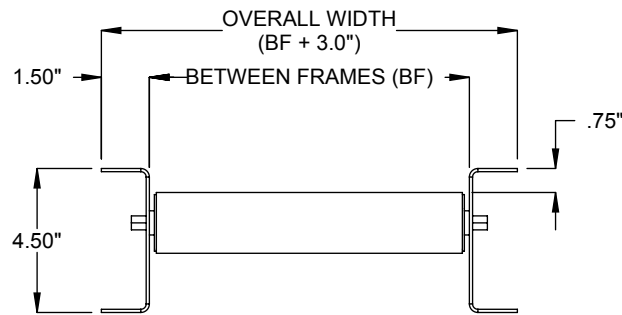

F38 CHANNEL, 4-1/2" x 1-1/2" x 12ga

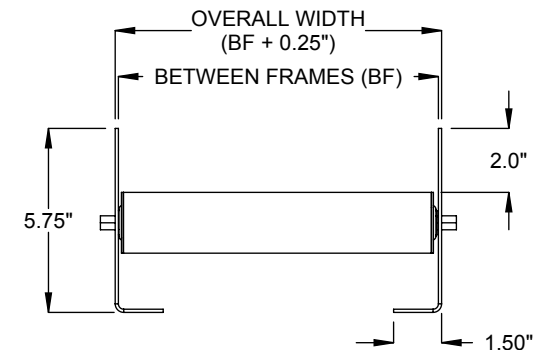

F61 ANGLE, 5-3/4" x 1-1/2" x 12ga
TOED IN
1916 ONLY

Model: 1909 - Gravity Roller Conveyor, 1.9 diameter 9 gauge roller
1912 - Gravity Roller Conveyor, 1.9 diameter 12 gauge roller
1916 - Gravity Roller Conveyor, 1.9 diameter 16 gauge roller