



CASTER CONCEPTS

Beyond Standard.



PRODUCT CATALOG

**HEAVY DUTY
INDUSTRIAL CASTERS**

2023

WWW.BANDCIP.COM

VERSION: 17.0



As we approach 32 years in business it is amazing to me how much this business has changed since 1987. With that said, it is also amazing to me how many things have not changed during that same period of time.

Let me share with you what has not changed first of all...

- Caster Concepts is a domestic manufacturer of industrial casters and wheels, always was, always will be.
- Domestic content of US made components in all of our products exceeds 98%.
- We started as a US manufacturer and are committed to US manufacturing.
- 80% of our supplier base is in a 60 mile radius of Albion, MI. We are proud to support US manufacturing.
- 80% of our work force lives within a 15 mile radius of our location.
- Caster Concepts has a highly skilled engineering team.
- Our strength is to design product for difficult applications, while providing a great standard product line.
- What the customer needs is the most important deliverable.
- You bought our products the first time because you trusted Caster Concepts and you continue to buy today for the same reason—TRUST. When failure is not an option.

Now let me share with you what is new...

- We manufacture in the most modern facility in a very competitive market.
- We have the most sophisticated manufacturing equipment in the industry.
- We manufacture all our components (except hardware) internally, allowing control of lead times.

- Our manufacturing process is controlled by our ISO 9001:2015 certification.
- Laser cutting and forming have essentially replaced stampings.
- Internal polyurethane hot casting capabilities give us the highest quality product in a predictable lead time.
- We are the only domestic heavy-duty caster manufacturer that has its own polyurethane operation.
- Our people are our great asset.

I could go on and I will trust you get the point...

The culture that Caster Concepts was built on 30 years ago is stronger today than it has ever been. It was the culture that was defined by my father Richard H. Dobbins in 1987 and it provides us with a moral compass today. What a great foundation.

In the meantime, we have invested significantly in technology for the business and it is my belief that we are the most sophisticated caster and wheel manufacturer in the US. We can design and manufacture faster than other businesses can find it on the shelf and box it. Caster Concepts is driven by continuous improvement and always developing processes to improve. We are a unique business that has no peer. I can say that because there is no other competitor that can do what we can do in the time frame we can do it. There is no reason to say we are working to be the best because Caster Concepts, Inc. is in a class of its own. We have the people to deliver on the "customer promise" 100% of the time and we go "Beyond Standard" to assure satisfaction.

William Dobbins, President & CEO
517-629-8838
bdobbins@casterconcepts.com

TABLE OF CONTENTS

CASTER BASICS.....	4-14
Caster Numbering System.....	4
Wheel Numbering System.....	5
Top Plate Sizes.....	6-7
Wheel Types.....	8-9
Durometer / Hardness Comparison Chart.....	9
Brake Types.....	10
Swivel Lock Types.....	11
Bearing Types.....	12
Other Caster Options.....	13
Caster Combinations / Truck Layouts.....	14
INDUSTRIES WE SPECIALIZE IN.....	15-23
Automotive.....	16
Aerospace.....	17
Ground Support.....	18
Warehousing / Distribution.....	19
Manufacturing.....	20
Heavy Equipment.....	21
Boat and Leisure.....	22
Train and Locomotive.....	23
AREAS OF EXPERTISE.....	24-28
Overexertion and Ergonomics.....	25
Noise and Hearing Loss.....	26
Moving Extremely Heavy Loads.....	27
Accidents and Collisions.....	28
CASTERS.....	29-128
Drive Caster®.....Motor Powered.....	30-31
TWERGO® XTREME.....Ergonomic.....	32-33
Hercules.....Extreme Use.....	34-35
Swivel On Swivel (SoS).....112 Series.....	36-37
Swivel On Swivel (SoS).....134 Series.....	38-39
Swivel On Swivel (SoS).....154 Series.....	40-41
CasterShoX®.....Noise Reducing.....	42-44
30 Series.....Medium Duty 900 lbs. max capacity.....	45-47
51 Series.....Kingpinless Style 1,500 lbs. max capacity.....	48-49
55 Series.....Kingpinless Style 1,000 lbs. max capacity.....	50-52
57 Series.....Kingpinless Style 1,500 lbs. max capacity.....	54-56
61 Series.....Kingpinless Style 3,500 lbs. max capacity.....	58-60
71 Series.....Kingpinless Style 4,500 lbs. max capacity.....	62-64
77 Series.....Kingpinless Style 3,500 lbs. max capacity.....	66-67

80 Series.....Extra Heavy Duty 5,000 lbs. max capacity.....	68-70
81 Series.....Kingpinless Style 10,000 lbs. max capacity.....	72-74
85 Series.....Extra Heavy Duty 10,000 lbs. max capacity.....	76-78
87 Series.....Extra Heavy Duty 5,000 lbs. max capacity.....	80-81
90 Series.....Extra Heavy Duty 8,000 lbs. max capacity.....	82-84
91 Series.....Kingpinless Style 20,000 lbs. max capacity.....	86-88
95 Series.....Extra Heavy Duty 17,000 lbs. max capacity.....	90-93
97 Series.....Super Heavy Duty 20,000 lbs. max capacity.....	94-97
99 Series.....Super Heavy Duty 35,000 lbs. max capacity.....	98-99
Dual Wheel.....50,000 lbs. max capacity.....	100-110
Modern Suspension.....Aluminum Casters 25,000 lbs. max capacity.....	112-115
Shock Absorbing.....20,000 lbs. max capacity.....	116-118
Vertical Spring.....3,800 lbs. max capacity.....	120-121
Compression.....1,500 lbs. max capacity.....	122-123
Pneumatic Wheel.....7,260 lbs. max capacity.....	124-128
V-Groove.....15,000 lbs. max capacity.....	130-132
Flanged.....12,000 lbs. max capacity.....	134-136
WHEELS.....	138-211
V-Groove.....15,000 lbs. max capacity.....	138-141
Flanged.....12,000 lbs. max capacity.....	142-147
Forged Steel.....20,000 lbs. max capacity.....	148-151
Cast Iron.....15,000 lbs. max capacity.....	152-156
Phenolic Resin.....8,000 lbs. max capacity.....	158-159
TWERGO®.....4,200 lbs. max capacity.....	160-162
TWERGO® Lite.....4,200 lbs. max capacity.....	164-165
Polyurethane.....11,250 lbs. max capacity.....	166-196
NyTec-MD.....9,360 lbs. max capacity.....	198-202
Keyway.....1,600 lbs. max capacity.....	204-206
Mold on Rubber.....3,000 lbs. max capacity.....	208-211
PARTS & ACCESSORIES	
Parts (Axles, Bushings, Bearings, Washers).....	212
TERMS & CONDITIONS.....	213

CASTER NUMBERING SYSTEM DEFINITIONS

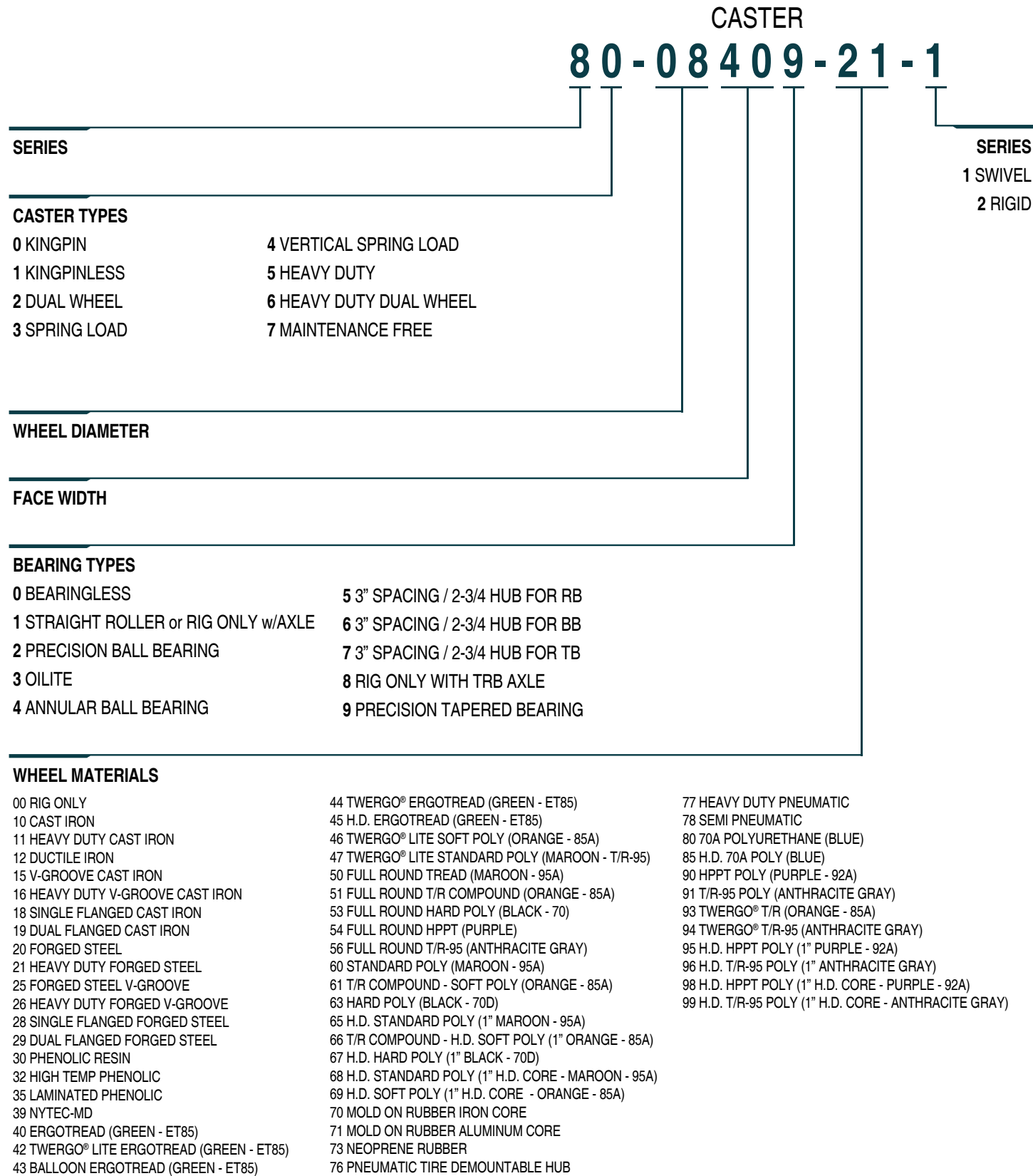

WHEEL NUMBERING SYSTEM DEFINITIONS

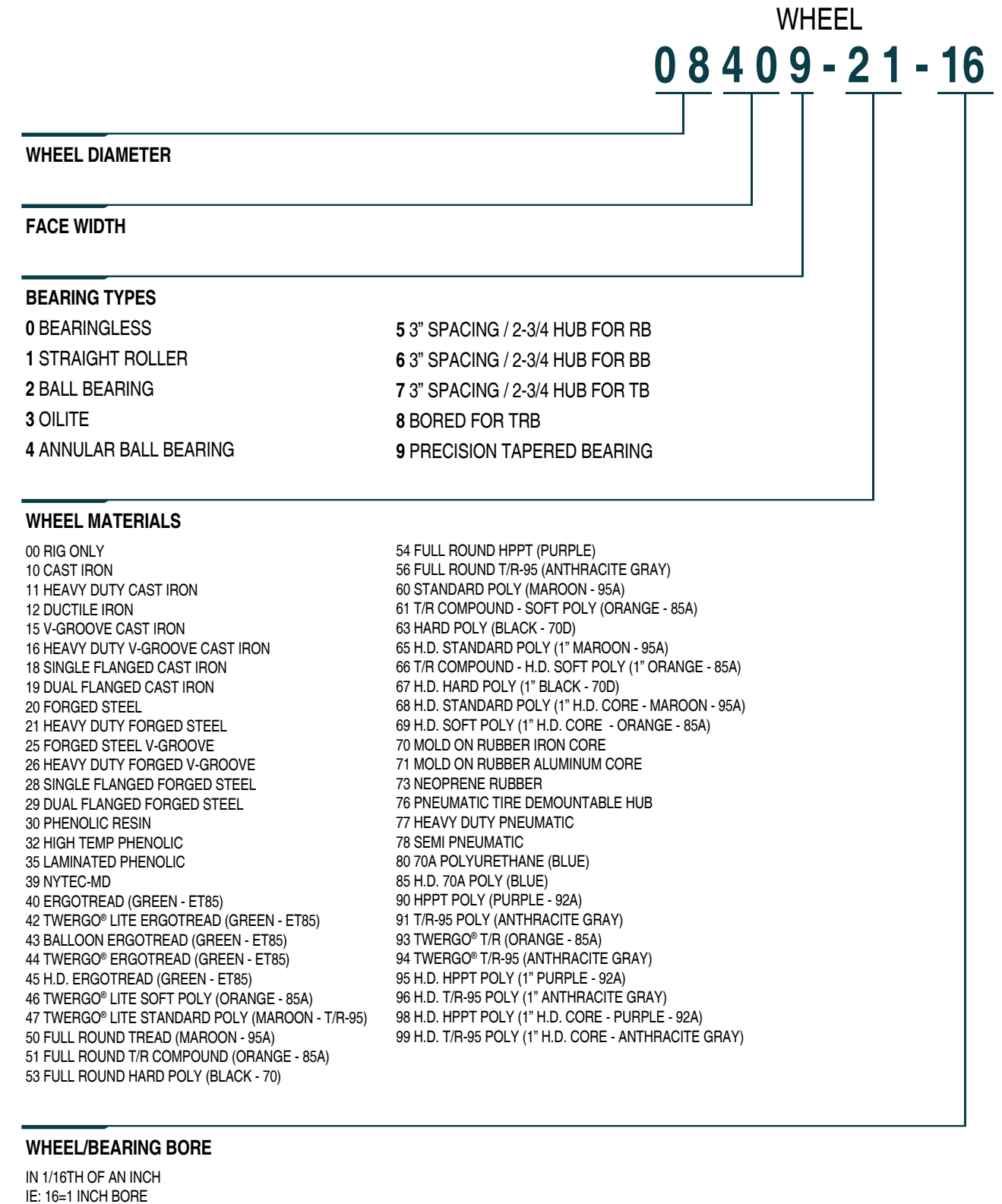

TOP PLATE SIZES

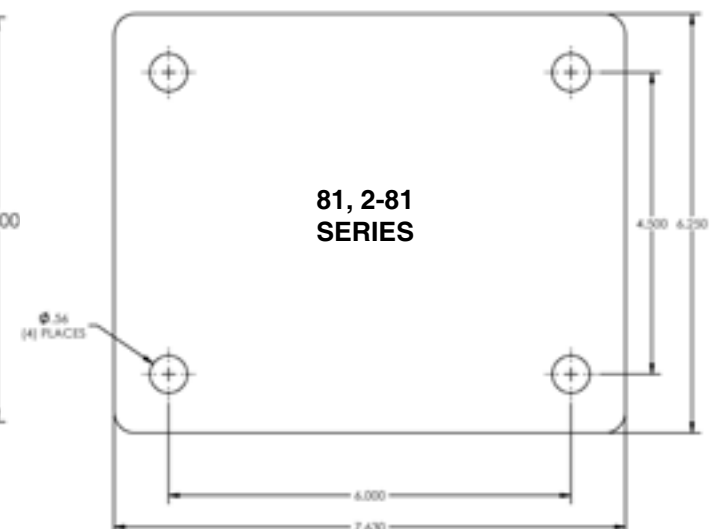
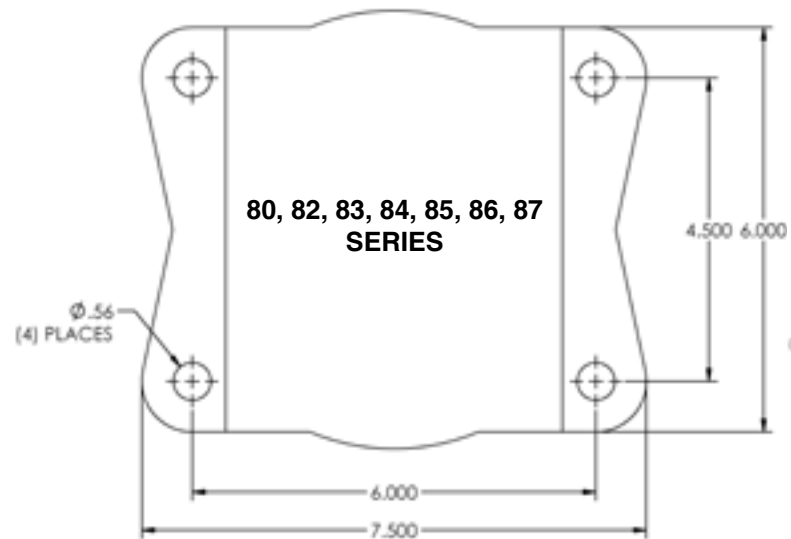
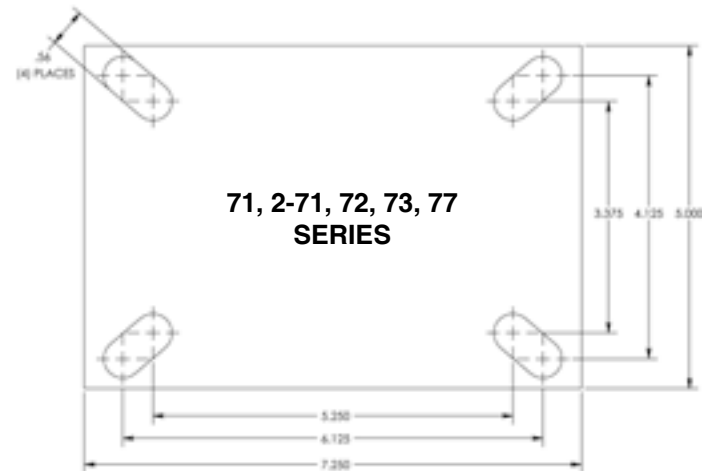
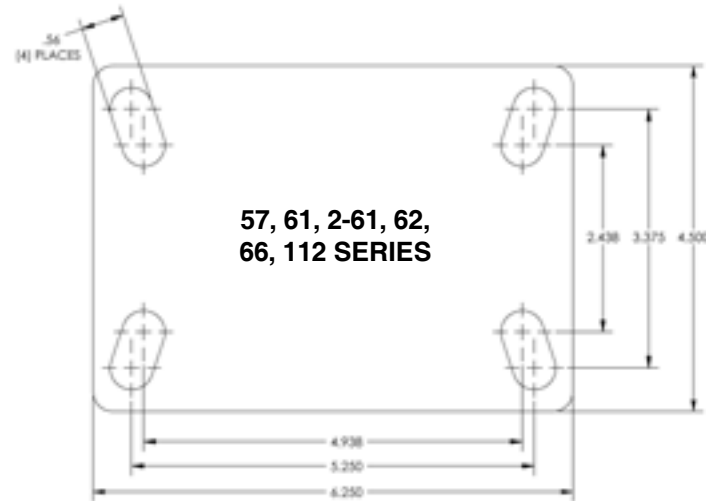
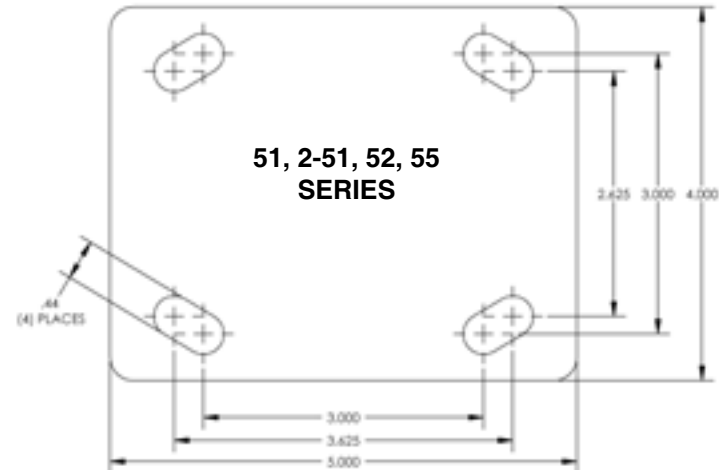
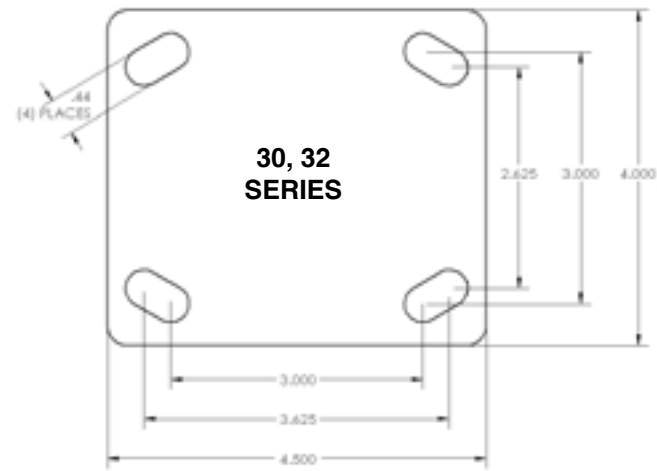

TOP PLATE SIZES

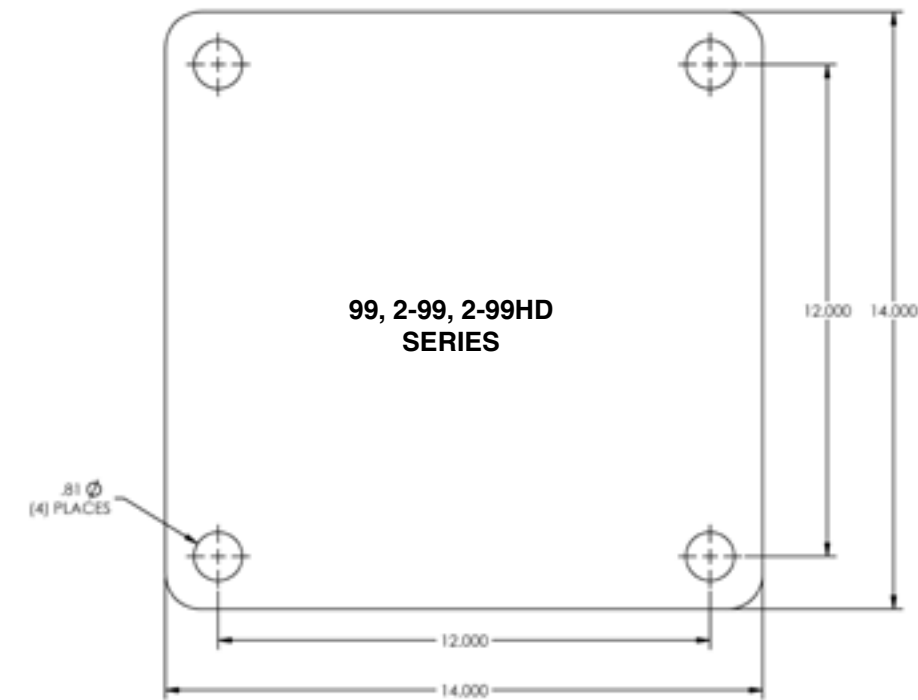
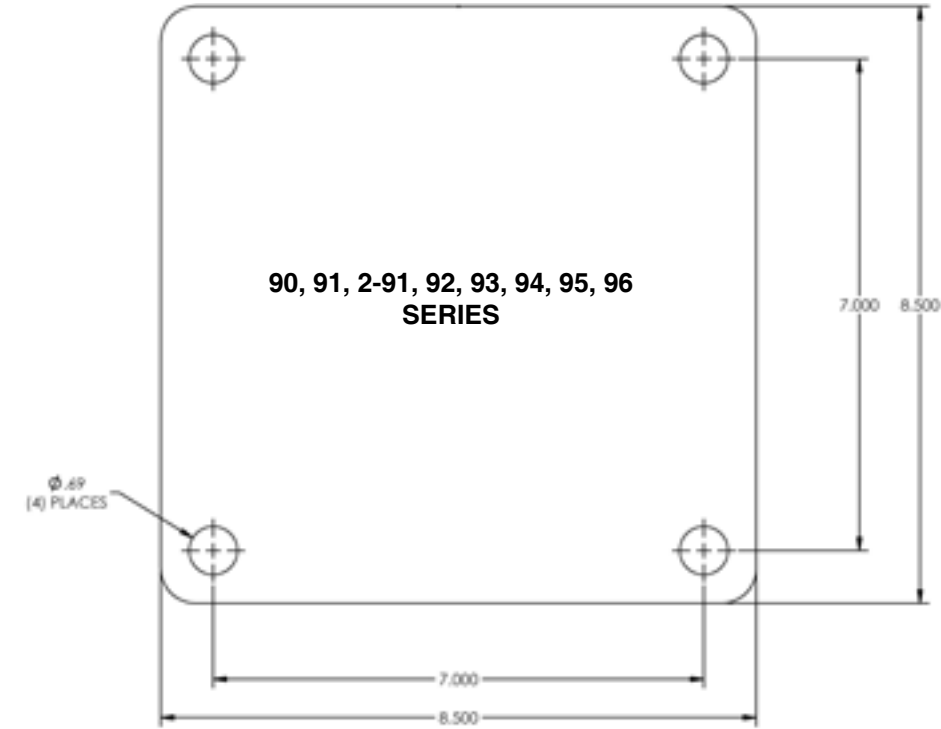

TOP PLATE THICKNESS

Series	Swivel	Rigid
30	1/4"	1/4"
51	3/8"	
52	3/8"	3/8"
55	3/8"	3/8"
57	5/16"	3/8"
61	3/8"	
62	3/10"	1/4"
66	3/10"	3/8"
71	3/8"	
72	3/8"	3/8"
73	3/8"	3/8"
77	3/8"	3/8"
80	1/2"	1/2"
81	1/2"	
82	1/2"	1/2"
83	1/2"	1/2"
84	1/2"	1/2"
85	1/2"	1/2"
86	1/2"	1/2"
87	1/2"	1/2"
90	5/8"	5/8"
91	5/8"	
92	5/8"	5/8"
93	5/8"	5/8"
94	5/8"	5/8"
95	5/8"	5/8"
99	1"	1"
112	3/8"	3/8"

Note: All top plate thicknesses are nominal. Forged top plates may vary.

WHEEL TYPES



FORGED STEEL

Fine grain forged steel wheels are precision machined to offer the greatest load capacity, impact strength and rollability. Precision tapered bearings complement the characteristics of these wheels.



CAST IRON

Precision machined cast iron wheels feature premium Class 30 gray iron with a heavy-duty cross sections. These wheels are excellent for high heat applications.



DUCTILE IRON

Ductile iron wheels feature many of the same characteristics of cast iron; however, the ductile iron wheel has higher tensile and yield strengths. Resists breaking or chipping.



POLYURETHANE

Polyurethane wheels feature a higher capacity material than rubber, provide longer wear, and will not damage your floors like cast iron or steel. A wide variety of liquid cast polyurethane wheels are offered.



MOLD ON RUBBER

Rubber offers a cost effective alternative to polyurethane while providing a cushioned and quiet ride for the product being transported. Neoprene and high load compounds are also available.



NYTEC-MD

NyTec-MD wheels provide a tough material which can handle up to 80% the weight of steel or cast iron. NyTec-MD has excellent load carrying capacities and resists corrosion. NyTec-MD provides a long wearing material and is especially suitable when maintenance is an issue.

WHEEL TYPES



PHENOLIC RESIN

Phenolic resin wheels offer a load carrying capacity approaching that of cast iron or steel wheels. Phenolic resin wheels are a cost effective alternative with increased rollability and will not damage floors.



V-GROOVE

"V" grooves are machined from either cast iron or hot forged steel wheels. V-grooves work on track or off track and are essential where precise alignment or indexing of equipment is necessary.



FLANGED

Single and dual-flanged wheels operate on a rail for locating fixtures in a precise position for indexing through a work cycle. Premium cast iron and steel is used for the wheel material to provide high strength and long wear.



PNEUMATIC / SEMI-PNEUMATIC

Pneumatic wheels offer the highest cushioning, shock absorbing caster/wheel, without moving to a more expensive spring loaded caster. Capacities of pneumatics are limited due to the soft cushioning characteristics of the wheel. Semi pneumatics are made of a hard rubber that has some elasticity and are not pressurized, therefore do not require air or foam, and will not go flat.



DRIVE / KEYWAY

Drive/Keyway wheels are offered from 3" to 18" diameter. Bore sizes from 1/2" to 2-7/16". Drive surfaces of poly, rubber, or steel. Excellent for power transmission applications.

HARDNESS COMPARISON CHART

Wheel Type	Tread Material	Durometer	Scale
N/A	Soft Tread Rubber	70-80	A
30, 32 & 35	Phenolics	102-104	E
60, 65 & 68	Polyurethane	90-100	A
61, 66 & 69	Soft Polyurethane	80-90	A
63 & 67	Hard Polyurethane	70	D
70	Rubber	65-75	A
71	Aluminum Core/Rubber	70-80	A
73	Neoprene	65-75	A
76	Pneumatic	55-60	A
80 & 85	70 A Polyurethane	70	A
90, 95 & 98	HPPT Polyurethane	92	A
91 & 96	95 A T/R Polyurethane	95	A

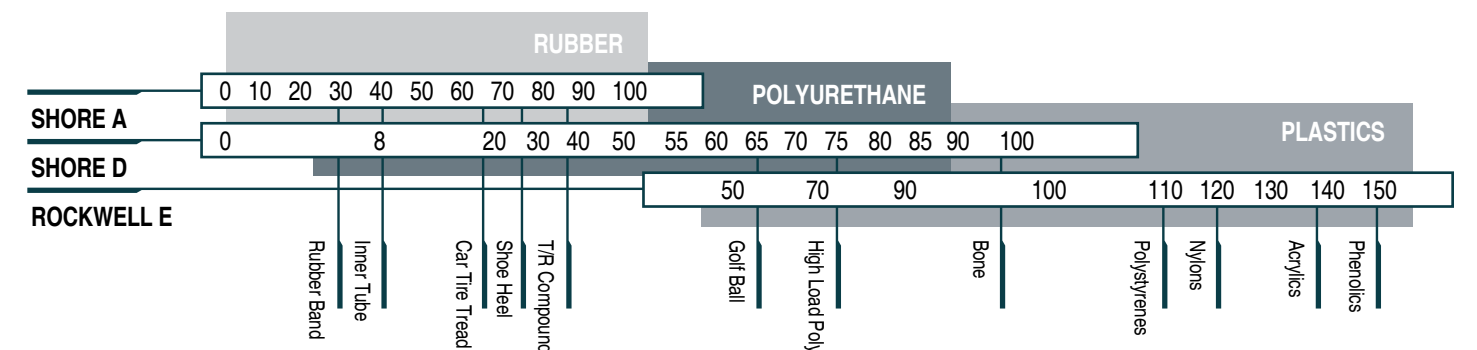

BRAKE TYPES



CAM (C)
The cam brake is used on lighter duty casters. This brake provides an efficient, cost-effective hub braking system.



POLY LOCK (P)
A polyurethane lock roller engages a steel brake shoe against the tread of the wheel providing positive engagement of the tread. Levers can be mounted "toe out" (shown) or reversed to "toe in."



SINGLE SIDE (SS)
The single-side brake is an economical brake for medium heavy-duty casters with 6- to 12-inch diameter wheels.



ERGO BRAKE (M)
Foot Actuated Wheel Brake designed to eliminate the bending, twisting and reaching that most brakes require, reducing the risk of injury. Offers a easily accessible lever that engages or disengages with a single motion. Only for 2-inch wide wheels.



FACE CONTACT (F)
The face contact brake is activated by tightening the brake shoe against the wheel.



DUAL SIDE (DS)
The dual side brake is a cost-effective hub brake. Each brake lever must be engaged by the operator.



PNEUMATIC POLY CAM (PP)
Similar to the standard poly cam brake in operation, the pneumatic poly cam brake offers a greater movement of the brake shoe to compensate for pneumatic tires. The brake is foot operated.



WRAP AROUND (W)
The wrap around brake provides total access to the braking system regardless of the caster orientation.

SWIVEL LOCK TYPES



SWIVEL LOCK (L)
The swivel lock provides notches every ninety degrees for use in straight line movement of the cart. Also available in 1, 3 or 8 position.



HEAVY-DUTY DEMOUNTABLE (DHDL)
The heavy-duty demountable swivel lock is a field-installed option available for the 80s and 90s series of casters.



HEAVY DUTY (HDL)
The heavy-duty swivel lock provides a longer, more accessible handle made from machined steel.



DEMOUNTABLE (DL)
The demountable swivel lock is a field-installed option available for casters up to the 71 Series.



FOOT ACTUATED SWIVEL LOCK (KL)
The locking mechanism on the foot operated swivel lock is the same as the standard swivel lock. To engage or disengage the lock, there is a pedal that can be operated by foot to improve ergonomics and speed of locking/unlocking a swivel caster.



PASSIVE (PL)
The passive swivel lock is used when full mobility of a unit is needed. The swivel lock plunger engages a detent and locks the caster for straight line movement. When side thrust is applied, the swivel unlocks providing maximum maneuverability of the unit. This swivel lock is NOT RECOMMENDED for towed applications.



VERTICAL MOUNTED (V)
The vertical mounted swivel lock is mounted out of the way, under the yoke base of the caster. Used mostly in heavy-duty applications, this swivel lock provides a more secure locking feature.

BEARING TYPES



ROLLER BEARINGS

The roller bearing is capable of carrying a greater load than the same size diameter ball bearing. It has a split outer race shell into which the roller assembly is inserted. The bearings are contained by hardened washers.



PRECISION TAPERED BEARINGS

The precision tapered bearing is the most effective bearing for heavy loads. It is capable of absorbing excessive side thrust loading and can be used where high speed operation is essential. Bearings should be periodically inspected to ensure proper adjustment.



PRECISION SEALED BALL BEARINGS

Recommended for maximum rolling ease with no maintenance lubrication required. Quiet operation for medium-duty to heavy-duty loads. Not suggested for severe side or impact loads.



ANNULAR BALL BEARING

Bearings are machined with hardened raceways. Ideal for applications where maximum rolling ease and quiet operation are needed. Best suited for light to medium-duty loads. Bearing is pre-assembled and the entire unit is mounted in the wheel.



DELRIN BEARINGS

Delrin bearings are extremely durable under a wide range of temperatures, humid conditions and are corrosion-resistant. Wheels with the Delrin bearings are well suited for applications such as steam cleaning or where excessive water or liquid is present.



OILITE AND BRONZE BEARINGS

Oilite bearings are impregnated with oil that self lubricates during use. It is resistant to corrosion and suited for wet applications, slow speeds, high heat and very low maintenance.

OTHER CASTER OPTIONS



ZERK FITTINGS

Threaded Zerk grease fittings are designed for every size caster. Threaded zerks are used in a variety of dynamic operations where the application is difficult and high level of maintenance is required.



CASTER WITH STEERING TUBES

Slots for steering handles allow precision motion control for casters with steering tubes. Steering tubes are used on industrial casters that carry heavy loads and need to be manipulated in very tight places.



TRACK BRUSH WIPER

Add a track wiper brush for extra protection against debris and build up. Track wiper brushes are utilized when any type of wheel is running on a track where debris can stop the movement, damage the wheel or take it off the track.



ANGLE REINFORCED LEGS

Heavy-duty angle reinforced legs provide maximum strength and rigidity. Reinforced Legs either angle iron on the outside of the leg or gussets on the inside serve to strengthen the caster when exposed to side loading.



TOE GUARD (TG)

The toe guard is mounted approximately one half of an inch off the floor to help protect workers' feet. It can be used in both manual and power applications.

CASTER COMBINATIONS

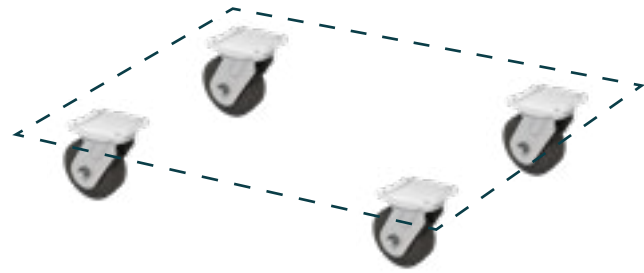

4 WHEEL NON-TILT (ALL SWIVELS)

This cart configuration can be maneuvered in any direction. Ideal for confined areas, but needs swivel lock for traveling long distances in a straight line.

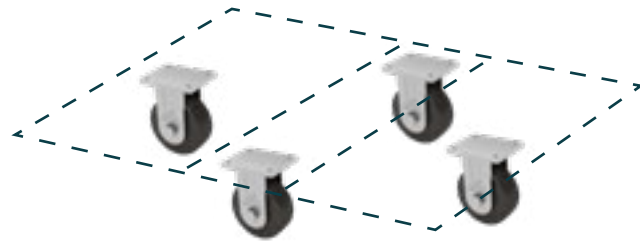

4 WHEEL DIAMOND PATTERN (ALL RIGID)

This tilt-type cart configuration rotates or pivots on the center wheels. This is the lowest cost cart configuration and is suitable for light loads. This design cannot be pushed sideways.

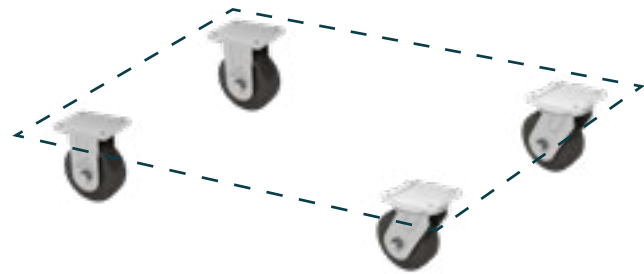

4 WHEEL CASTER STEER (2 SWIVELS, 2 RIGID)

This cart configuration is the most popular. It is easily turned or pushed straight and it also trails well.

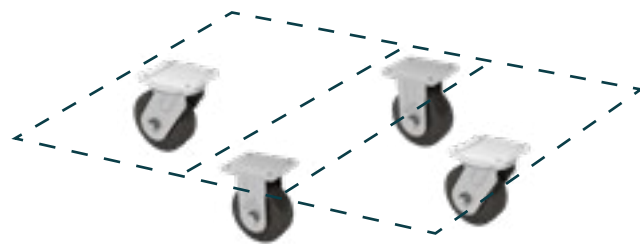

4 WHEEL DIAMOND PATTERN (2 SWIVELS, 2 RIGIDS)

This cart configuration is highly maneuverable and will rotate in its own length.

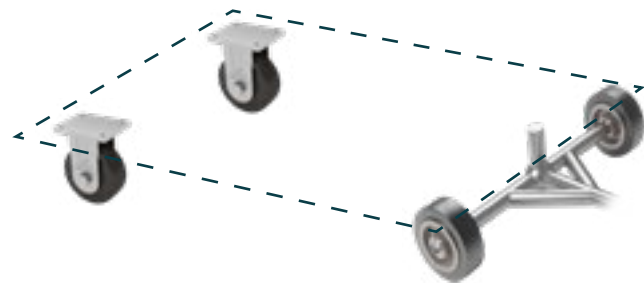

WAGON (FIFTH WHEEL STEER)

This trailer configuration features large axle mounted wheels for heavy loads. This is usually powered drawn.

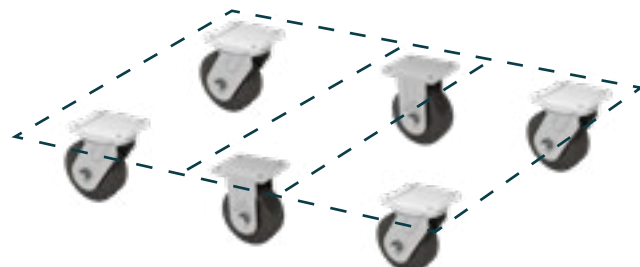

6 WHEEL TILT OR NON-TILT (4 SWIVEL, 2 RIGID)

This cart configuration is recommended for heavy loads and extra long trucks. It turns in its own length. The casters on the corners provide stability.

INDUSTRIES OF EXPERTISE

Caster Concepts has been committed to designing, building and supporting industrial casters for over 25 years. We specialize in casters used in manufacturing facilities of various industries, and have developed innovative and patented products that focus on the challenges commonly encountered in plants.

All of our products are proudly Made In America at our ISO 9001-2015 certified plant. We completely manufacture over 90% of our products, reducing the delays and risks of outsourcing. We are committed to building high quality products with exacting standards and high tolerance requirements.

Our engineering team is second to none, they have conquered challenges that many companies wouldn't even face, and they have cleaned up the messes that many companies have made. We're no strangers to complex problems, whether its weight capacity, environment, ergonomics or anything else related to material handling, we can help. Just like we have done for several companies in the following industries:

AUTOMOTIVE



The automotive industry is our primary market, it is the driving force behind many of the innovative products that we create. Whether its ergonomics, noise, heavy loads or automated guided vehicles (AGV), we have the right automotive industry casters for the job.

AEROSPACE



We offer a complete line of aerospace industry casters that are up to par for the grueling demands of aerospace applications that are lightweight and corrosion-resistant, yet durable.

GROUND SUPPORT EQUIPMENT



Ground support equipment is a demanding industry that requires the "beyond standard" durability that Caster Concepts is accustomed to offering. Ground support equipment is utilized to service aircraft before, after, and between flights.

WAREHOUSING AND DISTRIBUTION



Sound ergonomic practices can make or break a warehousing or distribution business's bottom line. Caster Concepts offers a wide variety of high-quality ergonomic products proven to lower required push and pull forces.

MANUFACTURING



Being one of the most recognized industrial caster wheels manufacturers, Caster Concepts is proud to offer several lines of heavy-duty industrial casters that can help achieve productivity, safety and efficiency goals that this industry is challenged with.

HEAVY EQUIPMENT



The manufacturing of cranes, bulldozers, tractors and other agricultural and construction machines & equipment can be grueling. Everything is bigger in the world of heavy equipment manufacturing, and that means substantial weight capacities that need to be moved safely, yet efficiently.

BOAT AND LEISURE VEHICLE



Manufacturers of marine and leisure vehicles have relied on Caster Concepts for help in improving safety, increasing productivity and solving unique challenges that arise during the production process.

TRAIN AND LOCOMOTIVE



Caster Concepts offers a wide variety of single flanged and V-groove wheels. Our heavy-duty caster wheel products are expertly machined to precise tolerances and capable of performing under the highest capacities.

AUTOMOTIVE INDUSTRY

Automotive manufacturing is an extremely competitive industry, one that is constantly looking to increase productivity and gain greater efficiency, while maintaining high standards for quality and safety. We know this all too well, because automotive manufacturing is the first market we served when we started Caster Concepts. Today, the automotive industry is our primary market, it is the driving force behind many of the innovative products that we create. Whether its ergonomics, noise, heavy loads or automated guided vehicles (AGV), we have the right automotive industry casters for the job. Our range of top quality automotive casters includes jack casters, tire casters, suspension casters, Drive Casters® & more, which are perfect for specific requirements in the automotive industry. **See recommended products below.**

WE OFFER A WIDE SELECTION OF MEDIUM AND HEAVY-DUTY COMMERCIAL CASTERS FOR THE AUTO INDUSTRY:

TWERGO®

TWERGO® unique tread thickness minimizes friction and eliminates scrubbing and sliding when turning, while providing the impact resistance of normal wheels. TWERGO® can reduce initial and continuous push force by an average of 25%, with some users even reporting as much as a 50% reduction in push force.

- Stamped Parts Carts
- Axle and Gear Carts
- Trash Gondolas
- Bumper and Parts Racks



TWERGO® LITE

TWERGO® Lite is also a wise replacement to a standard 2" wide caster. TWERGO® Lite has a durable cast iron core while adding the benefits of reduced initial and continuous push force at a competitive price. This single wheel version of our extraordinary TWERGO® wheels utilizes the same patented face design to reduce initial and continuous push force.

- Ergonomic, reduce force exerted to start and continue rolling
- Durable and Strong with a Cast Iron Core
- Maintenance-free bearings never need greasing



ERGOXCEL™ CASTER

ErgoXcel™ is our line of maintenance-free casters that never need greasing or any type of service. They feature precision neoprene sealed ball bearings and hardened raceways, ensuring smooth rotation for several years. The rounded tread that ErgoXcel™ features increases ergonomic benefits by reducing force exerted to keep rolling, as well as dispelling debris.

- Great for general assembly lines
- Ease of movement reduces force exerted
- Precision seals reduce noise caused by swivel
- Eliminates maintenance costs and hassle



CASTERSHOX®

CasterShoX® casters have the ability to reduce workplace noise to levels that are safer for all employees. CasterShoX® work great for transporting fragile components or products where repeated shocks may damage the components. CasterShoX® also provides an added value for ergonomic situations.

- Windshield / Window Transport Carts
- Small Part Carts
- Parent / Child Carts



AEROSPACE INDUSTRY

Aerospace is a very demanding industry, heavy loads, weather and environmental challenges, coupled with the stringent safety standards require superior products. The type of products that Caster Concepts is known for building. We offer a complete line of Aerospace industry casters that are up to par for the grueling demands of aerospace applications, as well as Modern Suspension System's line of completely aluminum casters that are lightweight and corrosion-resistant, yet durable.

In addition to our standard caster wheel products, we offer the capability to design a caster to meet your exact needs, and download a CAD model of that caster. We have designed and built several custom casters specifically for aerospace aviation companies, including the largest airplane manufacturer in the world, military contractors, private jet and helicopter manufacturers. **See recommended products below.**

MODERN SUSPENSION 440 SERIES (WITH SWIVEL LOCK)

Modern Suspension Systems, a line manufactured by Caster Concepts, was created to provide casters for the Aerospace industry that are heavy duty, shock absorbing, and corrosion resistant. Most major airlines, aircraft manufacturers and ground support service providers choose Modern.

- Heavy Duty Shock Absorption
- 4 Position Swivel Lock (at 3, 6, 9, 12 Positions)
- 12,500 lbs. Max Load Capacity



PNEUMATIC CASTERS

Pneumatic wheels are ideal for outdoor applications where there is rough or wet terrain. Pneumatic wheels perform through the elements and ensure that your equipment stands up to the daily challenges that the aerospace industry faces.

- Rubber Wheel
- Great for Wet Environments
- 7,500 lbs. Max Load Capacity



DRIVE CASTER®

The Drive Caster® is designed to move tons easily and efficiently, while offering the flexibility to integrate into a variety of applications beyond industrial carts and racks. This motor driven caster is powered by a 1/2hp electric motor that can move up to 5,000 lbs. total weight per caster.

- The industry's first motor powered industrial caster
- Can easily be integrated into most carts, racks and carriers
- Great for heavy load applications



HERCULES CASTERS

When you need a caster that can handle the abuse from demanding material handling applications such as severe side or impact loading as well as surface challenges including pot holes or floor debris, you can depend on the strength of Hercules Casters. Offering unrivaled durability, Hercules Casters feature reinforced legs to protect against severe side impact associated with forklifts and track channels.

- Smooth Rotating Action and Extended Lead
- Reinforced Legs
- Prolonged Life



GROUND SUPPORT INDUSTRY

Ground support equipment is a demanding industry that requires the “beyond standard” durability that Caster Concepts is accustomed to offering. Ground support equipment is utilized to service aircraft before, after, and between flights. There are numerous instruments of ground support equipment that move on wheels such as luggage carts, cargo decks, cargo dollies, and aircraft maintenance stands that must withstand the elements and the wear and tear that this industry faces daily.

Harsh weather environments brought upon by rain and snow, or hot and frigid temperatures make choosing the right caster for your ground support equipment a difficult task. Coupled with the varying weather conditions is the surface condition of the airport tarmac. Uneven surfaces, cracks in the cement, and obstructions such as rocks or debris can cause for a bumpy ride. This may cause costly damage to your valuable cargo, thus choosing a safe and durable caster for your application is of utmost importance. Caster Concepts supplies casters and wheels for ground support equipment around the world, providing industry-leading motion solutions from the ground up. **See recommended products below.**



AIR CARGO CASTERS

Our Air Cargo Casters are perfect for use on sorting desks and other applications where moving cargo and luggage on and off planes and platforms is a necessity.



CONVERSION DRIVE CASTER

The Conversion Drive Caster converts your existing material handling carts into Motor Powered Carts, quickly and easily. Simply remove one swivel caster and bolt in the Conversion Drive Caster and away you go. Can be used in almost any setting where a manually pushed cart was previously used to move loads up to 5,000 lbs.

- Convert existing carts into powered carts
- Fully integrated solution
- Virtually eliminate risk of overexertion injuries
- Reduce operators needed to move heavy loads.



PNEUMATIC CASTERS

Pneumatic wheels are ideal for outdoor applications where there is rough or wet terrain. Pneumatic wheels perform through the elements and ensure that your equipment stands up to the daily challenges that the aerospace industry faces.

- Rubber Wheel
- Great for Wet Environments
- 7,500 lbs. Max Load Capacity



MODERN SUSPENSION CASTERS

Our subsidiary Modern Suspension offers a completely aluminum line of casters that are ideal for outdoor applications, as Aluminum weighs less and is noncorrosive to withstand the elements. Modern Suspension also offers an extremely rugged and durable steel line featuring a greater max capacity per caster.

- Aircraft Maintenance Stand Casters
- Aircraft Engine Stand Casters
- Aircraft Wheel Dolly Casters

WAREHOUSING/DISTRIBUTION INDUSTRY

Sound ergonomic practices can make or break a warehousing or distribution business's bottom line. Injuries due to overexertion cost U.S. businesses over \$13.7 billion dollars in 2018 alone. Using the right material handling equipment is essential for creating the safest possible ergonomic environment in any organization. Caster Concepts offers a wide variety of high quality ergonomic products proven to lower required push and pull forces: ErgoXcel™ Maintenance-Free Rigs, Crown casters, TWERGO® wheels, TWERGO® Lite wheels, and round tread wheels are excellent solutions for your ergonomic needs.

As one of the well-known caster suppliers, Caster Concepts also offers a variety of powered applications for organizations looking to maximize efficiency and reduce the risk of overexertion injuries even further. If these solutions could benefit your business, then you should take a look at our line of Drive Casters® or Conversion Drive Casters. **See recommended products below.**



ERGOXCEL™ CASTER

ErgoXcel™ is our line of maintenance-free casters that never need greasing or any type of service. They feature precision neoprene sealed ball bearings and hardened raceways, ensuring smooth rotation for several years. The rounded tread that ErgoXcel™ features increases ergonomic benefits by reducing force exerted to keep rolling, as well as dispelling debris.

- Great for general assembly lines
- Ease of movement reduces force exerted
- Precision seals reduce noise caused by swivel
- Eliminates maintenance costs and hassle



DRIVE CASTER®

The Drive Caster® is designed to move tons easily and efficiently, while offering the flexibility to integrate into a variety of applications beyond industrial carts and racks. This motor driven caster is powered by a 1/2hp electric motor that can move up to 5,000 lbs. total weight per caster.

- The industry's first motor powered industrial caster
- Can easily be integrated into most carts, racks and carriers
- Great for heavy load applications



TWERGO® LITE

TWERGO® Lite is also a wise replacement to a standard 2" wide caster. TWERGO® Lite has a durable cast iron core while adding the benefits of reduced initial and continuous push force at a competitive price. This single wheel version of our extraordinary TWERGO® wheel utilizes the same patented face design to reduce initial and continuous push force.

- Ergonomic, reduce force exerted to start and continue rolling
- Durable and Strong with a Cast Iron Core
- Maintenance-free bearings never need greasing



CUSTOM CASTERS

Unique challenges require custom solutions, solutions that are built to exact specifications. Our flexible manufacturing process enables us to build the exact caster for your needs. If you don't find the exact caster for your needs, take a look at our custom CAD configurator, or contact us and we will design and build the exact caster for your needs.

- All of our casters are built-to-order and to exact specifications
- We don't follow the cookie cutter manufacturing system used by other caster manufacturers
- We offer engineering design services as well as our custom configurator
- Design custom CAD models that can easily be integrated into your models

MANUFACTURING INDUSTRY

Industrial manufacturing has some of the most demanding efficiency goals of any industry type. To meet these demands, having the right manufacturing industrial casters is a necessity. Efficiency and productivity are critical, while protecting the load being transported is just as important. Transporting industrial products throughout the manufacturing process can be extremely challenging, since there are the obvious concerns of scratching, denting or causing other damage issues. Being one of the most recognized industrial caster wheels manufacturers, Caster Concepts is proud to offer several lines of heavy-duty industrial casters that can help achieve productivity, safety and efficiency goals that this industry is challenged with. **See recommended products below.**

HERCULES CASTERS



When you need a caster that can handle the abuse from demanding material handling applications such as severe side or impact loading as well as surface challenges including pot holes or floor debris, you can depend on the strength of Hercules Casters. Offering unrivaled durability, Hercules Casters feature reinforced legs to protect against severe side impact associated with forklifts and track channels.

- Smooth Rotating Action and Extended Lead
- Reinforced Legs
- Prolonged Life

CONVERSION DRIVE CASTER



The Conversion Drive Caster converts your existing material handling carts into Motor Powered Carts, quickly and easily. Simply remove one swivel caster and bolt in the Conversion Drive Caster and away you go. Can be used in almost any setting where a manually pushed cart was previously used to move loads up to 5,000 lbs.

- Convert existing carts into powered carts
- Fully integrated solution
- Virtually eliminate risk of overexertion injuries
- Reduce operators needed to move heavy loads

ERGOXCEL™ CASTER



ErgoXcel™ is our line of maintenance-free casters that never need greasing or any type of service. They feature precision neoprene sealed ball bearings and hardened raceways, ensuring smooth rotation for several years. The rounded tread that ErgoXcel™ features increases ergonomic benefits by reducing force exerted to keep rolling, as well as dispelling debris.

- Great for general assembly lines
- Ease of movement reduces force exerted
- Precision seals reduce noise caused by swivel
- Eliminates maintenance costs and hassle

CASTERSHOX®



CasterShoX® casters have the ability to reduce workplace noise to levels that are safer for all employees. CasterShoX® work great for transporting fragile components or products where repeated shocks may damage the components. CasterShoX® also provides an added value for ergonomic situations.

- Windshield / Window Transport Carts
- Small Part Carts
- Parent / Child Carts

HEAVY EQUIPMENT INDUSTRY

The manufacturing of cranes, bulldozers, tractors and other agricultural and construction machines & equipment can be grueling. Everything is bigger in the world of heavy equipment manufacturing, and that means substantial weight capacities that need to be moved safely, yet efficiently.

Workflow optimization is a greater challenge when parts weigh hundreds, even thousands of pounds. Carts and carriers are taxed with supporting massive loads, creating challenges and safety concerns. Additionally, some components are so large that they require custom mobility solutions, solutions that require custom casters that can support the heavy load, mount to unique requirements and provide fluid movement. **See recommended products below.**

DRIVE CASTER®



The Drive Caster® is designed to move tons easily and efficiently, while offering the flexibility to integrate into a variety of applications beyond industrial carts and racks. This motor-driven caster is powered by a 1/2hp electric motor that can move up to 5,000 lbs. total weight per caster.

- The industry's first motor powered industrial caster
- Can easily be integrated into most carts, racks and carriers
- Great for heavy load applications

HEAVY-DUTY 2-81 SERIES CASTERS



We offer a complete line of heavy-duty casters that will handle the harshest environments and support up to 25 tons EACH. Several wheel options are available to ensure the perfect fit for your application. We have built heavy-duty casters for use on carts, racks, airplane platforms, rail cars, steel haulers and so many more!

- Low Profile Casters
- Heavy-Duty Swivel Lock Casters
- Capacities range from 4,000lb loads, to a 200,000lb loads or more

TWERGO® WHEELS



TWERGO® unique tread thickness minimizes friction and eliminates scrubbing and sliding when turning, while providing the impact resistance of normal wheels. TWERGO® can reduce initial and continuous push force by an average of 25%, with some users even reporting as much as a 50% reduction in push force.

- Stamped Parts Carts
- Axle and Gear Carts
- Trash Gondolas
- Bumper and Parts Racks

CUSTOM CASTERS



Unique challenges require custom solutions, solutions that are built to exact specifications. Our flexible manufacturing process enables us to build the exact caster for your needs. If you don't find the exact caster for your needs, take a look at our custom CAD configurator, or contact us and we will design and build the exact caster for your needs.

- All of our casters are built-to-order and to exact specifications
- We don't follow the cookie cutter manufacturing system used by other caster manufacturers
- We offer engineering design services as well as our custom configurator
- Design custom CAD models that can easily be integrated into your models

BOAT AND LEISURE INDUSTRY

Manufacturers of marine and leisure vehicles have relied on Caster Concepts for help in improving safety, increasing productivity and solving unique challenges that arise during the production process. In addition to a full catalog of products, we offer innovative custom solutions for those extremely difficult applications. For example, the load weight and length of carts used in the assembly process of large boats posed a great challenge for the operators, and safety was a primary concern. This led to the development of our Conversion Drive Caster, which addressed these concerns and made it easy to move extremely heavy and hard to maneuver loads. **See recommended products below.**

MODERN SUSPENSION CASTERS



Our subsidiary Modern Suspension offers a completely aluminum line of casters that are ideal for outdoor applications, aluminum weighs less and is noncorrosive to withstand the elements. While their extremely rugged and durable steel line offers a greater max capacity per caster.

- Aircraft Maintenance Stand Casters
- Aircraft Engine Stand Casters
- Aircraft Wheel Dolly Casters

PNEUMATIC CASTERS



Pneumatic wheels are ideal for outdoor applications where there is rough or wet terrain. Pneumatic wheels perform through the elements and ensure that your equipment stands up to the daily challenges that the aerospace industry faces.

- Rubber Wheel
- Great for Wet Environments
- 7,500 lbs. Max Load Capacity

CONVERSION DRIVE CASTER



The Conversion Drive Caster converts your existing material handling carts into Motor Powered Carts, quickly and easily. Simply remove one swivel caster and bolt in the Conversion Drive Caster and away you go. Can be used in almost any setting where a manually pushed cart was previously used to move loads up to 5,000 lbs.

- Convert existing carts into powered carts
- Fully integrated solution
- Virtually eliminate risk of overexertion injuries
- Reduce operators needed to move heavy loads.

HEAVY-DUTY 81 SERIES CASTERS



Heavy-Duty Casters are manufactured to withstand abusive applications. The heat treated raceways are designed to prevent brinelling of the raceways. The laser cut formed legs provide additional strength when side loading or skidding is prevalent in the application. The exceptional strength makes it an ideal choice for rugged jobs.

- Wide selection available
- Custom engineered casters available for unique applications
- Aluminum casters or Zinc plated metal to reduce risk of corrosion
- Numerous wheel options from poly to rubber to steel and more

TRAIN AND LOCOMOTIVE INDUSTRY

The type of equipment required to build and maintain the railroad cars of today need to be as rugged and reliable as the rail cars themselves. Caster Concepts offers a wide variety of single flanged and V-groove wheels. Our heavy-duty caster wheel products are expertly machined to precise tolerances and capable of performing under the highest capacities. We've been providing train and locomotive industry leaders with Beyond Standard manufacturing solutions for years. **See recommended products below.**

V-GROOVE WHEEL



Caster Concepts offers a variety of cast iron and forged steel v-groove wheels capable of use on either tracks or flat surfaces. Our v-groove casters and wheels are ideal for heavy loads and can be machined for various bore sizes.

- The industry's first motor powered industrial caster
- Can easily be integrated into most carts, racks and carriers
- Great for heavy load applications

SINGLE AND DUAL FLANGED WHEELS



Flanged wheels are designed to operate on steel tracking to minimize guidance and rolling effort.

Caster Concepts offers a wide variety of heavy-duty flanged wheel casters that are engineered to take on the highest capacities. Both dual and single flanged options are available in either cast iron or steel.

- Low Profile Casters
- Heavy-Duty Swivel Lock Casters
- Capacities range from 4,000lb loads, to 200,000lb loads, or more

DRIVE CASTER®



The Drive Caster® is designed to move tons easily and efficiently, while offering the flexibility to integrate into a variety of applications beyond industrial carts and racks. This motor driven caster is powered by a 1/2hp electric motor that can move up to 5,000 lbs. total weight per caster.

- The industry's first motor powered industrial caster
- Can easily be integrated into most carts, racks and carriers
- Great for heavy load applications

CUSTOM CASTERS



Unique challenges require custom solutions, solutions that are built to exact specifications. Our flexible manufacturing process enables us to build the exact caster for your needs. If you don't find the exact caster for your needs, take a look at our custom CAD configurator, or contact us and we will design and build the exact caster for your needs.

- All of our casters are built-to-order and to exact specifications.
- We don't follow the cookie cutter manufacturing system used by other caster manufacturers
- We offer engineering design services as well as our custom configurator.
- Design custom CAD models that can easily be integrated into your models.

WORKPLACE SAFETY

The value of casters in the workplace is often overlooked, those wheels on the bottom of a cart can do a lot more than just roll. The right caster wheels can have a tremendous impact on health and safety, not to mention employee productivity and performance. We have created innovative caster wheel products to help protect workers against some of the most common and costly threats, including:

OVEREXERTION AND ERGONOMICS

Overexertion involving an outside force is the leading cause of injury in the workplace and cost U.S. businesses over \$15 billion according to the 2016 Liberty Mutual Workplace Safety Index. In addition to monetary costs, overexertion injuries result in longer time off for recovery than the average of other injuries, it impacts morale and can reduce overall performance.

One force that may lead to overexertion injuries are industrial carts. Industrial carts often move loads weighing thousands of pounds, requiring several pounds of force exerted to start, keep rolling and turn. Workers are often required to exert this force consistently throughout the work day, greatly increasing the risk of overexertion injuries. Ergonomic casters can reduce force exerted and the risk of injuries due to overexertion. Caster Concepts **TWERGO**® wheels can reduce initial and continuous push force by an average of 25%, with some users even reporting as much as a 50% reduction in push force.

NOISE AND HEARING LOSS

According to the Bureau of Labor Statistics, Hearing loss is the second most common illness in the workplace. Unfortunately, unlike some other diseases, hearing loss is not reversible. There is no way to gain back what is lost.

In addition to risk of hearing loss, excessive noise has several other negative effects on employees. It makes communication difficult and greatly increases the risk for errors, creates agitation and reduces employee morale, and can increase stress and anxiety, to name a few. Not to mention the penalties that can be imposed by the Occupational Health and Safety Administration (OSHA).

OSHA has strict guidelines about noise levels and length of exposure to noise at those levels (Occupational Health and Safety Act 1910.95), and just a 5 decibel increase can cut exposure time in half, meaning an 8 hour work day becomes a 4 hour work day. If the increase is 15 decibels, that work day is reduced to just 1 hour long! OSHA recommends "engineering controls" to reduce noise, such as **CasterShoX**® casters with the ShoX® absorption system integrated into the core to address the shock at the source.

MOVING EXTREMELY HEAVY LOADS

Extremely heavy loads can also cause risk of failure to equipment, having the wrong caster can be catastrophic. If a wheel locks up it could cause the operator muscle strains, if the caster collapses under the load, materials can come tumbling down on the operator or other workers, as well as other damage and injuries. Rest assured, we are experts in designing and building Heavy-Duty Casters to conquer just about any challenge. And if the right caster is not in our catalog, we will design a custom caster for your application, as we have done for thousands of customers including the largest manufacturers in the world. Our engineering team will work with you to design the exact caster for the application.

ACCIDENTS AND COLLISIONS

Injuries due to being struck by an object or equipment is the fourth most common cause of injury in the workplace and costs US companies over \$5 billion dollars, according to the 2016 Liberty Mutual Workplace Safety Index. With industrial carts weighing thousands of pounds when loaded, they can create a very serious threat to operators and other workers as well.

Caster Concepts offers a complete line of options and accessories that can help reduce the risk of an accident. Accessories like Toe Guards to prevent a cart rolling over someone's foot, or **caster brakes** to keep the cart from rolling away, especially while being loaded or unloaded. **Swivel Locks** allow for greater control by eliminating the swivel function in a caster and lock the wheels in a specified direction, making it easier to steer the cart.

OVEREXERTION AND ERGONOMICS

Caster Concepts has developed a complete line of ergonomic casters, wheels and related accessories for companies, engineered to reduce initial, continuous and turning push/pull force. Our ergonomic caster wheel products range from our patented **TWERGO**® wheels that achieve unrivaled force reduction to the **Drive Caster**®, the first motor powered industrial caster that can move extremely heavy loads effortlessly. Check out our complete line of ergonomic caster wheel products below. **See recommended products below.**

SOS (SWIVEL ON SWIVEL) CASTERS

The swivel on swivel caster achieves significant reductions in push force that almost no other caster can. SoS caster is maintenance free, thanks to a kingpinless design and precision ball bearings. The design also virtually eliminates any side to side shifting when the wheels rotate 180 degrees.



DRIVE CASTER®

The Drive Caster® is designed to move tons easily and efficiently, while offering the flexibility to integrate into a variety of applications beyond industrial carts and racks. This motor-driven caster is powered by a 1/2hp electric motor that can move up to 5,000 lbs. total weight per caster.

TWERGO®

TWERGO® unique tread thickness minimizes friction and eliminates scrubbing and sliding when turning, while providing the impact resistance of normal wheels. TWERGO® can reduce initial and continuous push force by an average of 25%, with some users even reporting as much as a 50% reduction in push force.



CONVERSION DRIVE CASTER

The Conversion Drive Caster converts your existing material handling carts into Motor Powered Carts, quickly and easily. Simply remove one swivel caster and bolt in the Conversion Drive Caster and away you go. Can be used in almost any setting where a manually pushed cart was previously used to move loads up to 5,000 lbs.

TWERGO® LITE

TWERGO® Lite is also a wise replacement to a standard 2" wide caster. TWERGO® Lite has a durable cast iron core while adding the benefits of reduced initial and continuous push force at a competitive price. This single wheel version of our extraordinary TWERGO® wheel utilizes the same patented face design to reduce initial and continuous push force.



TWERGO® XTREME

This heavy-duty configuration has dual benefits. It significantly reduces push/pull force while giving operators the ability to move even heavier loads. All wheels rotate independently of each other and are designed to minimize rolling resistance. The casters also have a very long tread life and are maintenance free.

ERGOXCEL™ CASTER

ErgoXcel™ is our line of maintenance-free casters that never need greasing or any type of service. They feature precision neoprene sealed ball bearings and hardened raceways, ensuring smooth rotation for several years. The rounded tread that ErgoXcel™ features increases ergonomic benefits by reducing force exerted to keep rolling, as well as dispelling debris.



ROUND TREAD WHEELS

Caster Concepts offers this popular wheel with various polyurethane tread formulations, ensuring the best tread material for your specific challenges. The Round, or Crown Tread wheel is primarily an ergonomic wheel, with lower weight capacities than conventional poly on cast iron wheels.

NOISE AND HEARING LOSS

Hearing Loss is the 2nd most common illness suffered in the workplace, the US Department of Labor has regulations about noise exposure through OSHA. OSHA's regulations state that 90 decibels dBa is the highest noise level an employee can be exposed to for 8 hours (a standard work day). Every increase of 5 dBa, reduces allowable exposure time in half. CasterShoX® were designed especially to reduce noise and vibration on carts. The patented CasterShoX® absorption system located in the center of a CasterShoX® wheel, absorbs shock minimizing and even eliminating vibration that causes noise on carts. CasterShoX® functions like shock absorbers on a vehicle, minimizing impact on the cart and its contents. **See recommended products below.**



CasterShoX® Casters and wheels reduce noise and are a simple solution to a problem that plagues most every manufacturing operation, noise. CasterShoX® wheels are available in standard sizes and fit in the same available space as the previous caster. Retrofitting carts with a CasterShoX® caster is as easy as changing out the previous caster and bolting on the new version. CasterShoX® come in two standard sizes, 6x2 and 8x2, and in a standard configuration would be fit into a 51 Series caster rig. CasterShoX® utilize patented technology that combines the very best attributes of spring technology and polymer dampening technology to provide a product that is unsurpassed in dampening noise of a manufacturing environment. All components are built directly into the hub of the wheel. Fully compatible with standard 6- and 8-inch casters, implementation of this new technology is seamless. CasterShoX® offer cost effective noise reduction, shock absorption and vibration control.

CasterShoX®	vs.	Spring Loaded Casters
<ul style="list-style-type: none"> Designed to achieve ultimate noise and shock reduction Patented design with customer formulated elastomer spring and damping quickly stops vibration Absorbs shock at the axle level reducing impact on cart and contents 		<ul style="list-style-type: none"> Designed to reduce impact of shock Metal coil spring expands and contracts continuously until shock is fully dissipated Springs are external to wheels, spreading vibration on to the cart and contents

Specifications			
CAPACITY	Maximum 1,500 lbs. Per Caster	DUROMETER	70A, 85A, 95A, 70D, Custom polyurethane available
WHEEL SIZES	6x2 8x2	BEARING TYPE	Precision Sealed Ball Bearing, Maintenance Free
WHEEL CORE	Aluminum and Cast Iron	CASTER OPTIONS	Brakes, Swivel Locks, Toe Guard, Sealed Swivel Sections

MOVING EXTREMELY HEAVY LOADS

Some applications require moving loads that weigh tons, which can cause a ton of concerns! Extremely heavy loads usually put a strain on workers, requiring multiple operators. We can help alleviate those concerns and free up operators with the industry's first motor powered caster, the Drive Caster®. This motor powered caster can move up to 5,000 lbs effortlessly, the only force exerted is that required to push a button. For heavier loads or to add steering, incorporate a second Drive Caster®. **See recommended products below.**

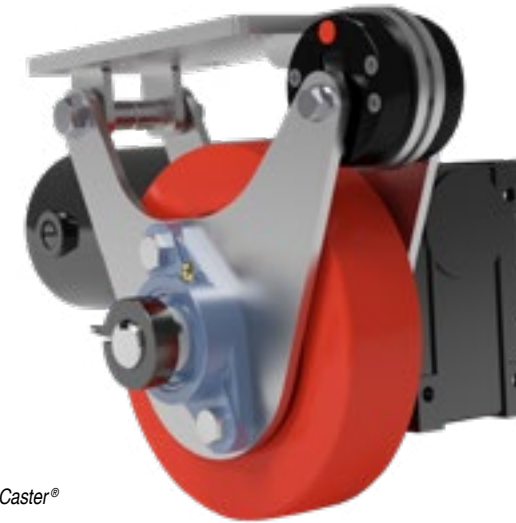

1/2HP Drive Caster®



Trike Conversion System

APPLICATIONS

- Carts
- Dollies
- Walls
- Platforms
- Turntables



Drive Caster® Specifications	
TOP PLATE	60 Series with 1/2" Bolts
WHEEL TYPE	70A Polyurethane Wheel
WHEEL SIZE	8 x 2"
WEIGHT	35 lbs.
OAH (OVERALL HEIGHT)	10.13"
1/2 HP DRIVE CASTER®	24VDC Brushed Motor - 30 amp Current Draw

Performance Specifications	
MAX LOAD CAPACITY	2,000 lbs.
MAX TOWING CAPACITY	5,000 lbs.
MAX PEAK TORQUE	1,000 in-lbs.
CONTINUOUS TORQUE	Max 250 in-lbs.
SPEED	1-2 MPH



Conversion Drive Caster

The Conversion Drive Caster is a fully integrated battery powered unit designed to move and maneuver loads up to 5,000 pounds. The unit features intuitive controls that can be mastered in just a few minutes of training. With customizable top plates, installation is as easy as replacing any caster. Once installed the Conversion Drive Caster removes virtually any manual effort required to move a cart. This removes almost any chance of an injury caused by overexertion or fatigue.

ACCIDENTS AND COLLISIONS

Certain types of casters are designed to provide improved safety benefits in certain types of environments. For example, casters with brakes allow individuals to stop their loads quickly, even despite their weight. When a cart or rack is in motion and comes across an individual or another cart or rack, the ability to stop quickly and safely is key. For this reason, it is important to think about the way the load moves, how it moves, and how many loads are in motion at once when choosing the right caster for your unique needs. Swivel Locks make it easier to control the cart or rack when rolling and can be used to ensure wheels stay perfectly parallel when a cart is parked (this is beneficial because it requires greater force to start rolling a cart when the wheels are parallel). **See recommended products below.**



CAM (C)

The cam brake is used on lighter duty casters. This brake provides an efficient, cost-effective hub braking system.



POLY LOCK (P)

A polyurethane lock roller engages a steel brake shoe against the tread of the wheel providing positive engagement of the tread. Levers can be mounted “toe out” (shown) or reversed to “toe in.”



PNEUMATIC POLY CAM (PP)

Similar to the standard poly cam brake in operation, the pneumatic poly cam brake offers a greater movement of the brake shoe to compensate for pneumatic tires. The brake is foot operated.



ERGO BRAKE (M)

Foot Actuated Wheel Brake designed to eliminate the bending, twisting and reaching that most brakes require, reducing the risk of injury. Offers a easily accessible lever that engages or disengages with a single motion. Only for 2-inch wide wheels.



SWIVEL LOCK (L)

The swivel lock provides notches every ninety degrees for use in straight line movement of the cart. Also available in 1, 3 or 8 position.



PASSIVE (PL)

The passive swivel lock is used when full mobility of a unit is needed. The swivel lock plunger engages a detent and locks the caster for straight line movement. When side thrust is applied, the swivel unlocks providing maximum maneuverability of the unit. This swivel lock is NOT RECOMMENDED for towed applications.

FOOT ACTUATED SWIVEL LOCK (KL)

One issue that may arise from the use of brakes and swivel locks is a risk of the operator suffering from exertion due to excessive reaching, twisting, bending etc. Because the brakes and swivel locks are physically mounted on the casters, they are at the bottom of the cart or rack and require the operator to bend down and reach to engage them. If the brake or swivel lock is on a swivel caster, there is a chance that the lever to engage the unit may rotate under the cart, requiring the operator to twist, bend and extend their reach, increasing the risk of an injury.

For these reasons, we have created Foot Actuated Brakes and Foot Actuated Swivel Locks. These units are engaged and disengaged easily by a single motion of the operators foot, eliminating the need to bend or reach down. The foot actuated swivel lock is mounted in a manner to eliminate it from rotating under the cart, ensuring easy access at all times.



OUR LINE OF HEAVY-DUTY CASTERS

MOTOR POWERED DRIVE CASTER®



MAXIMUM CAPACITY

5,000 lbs.

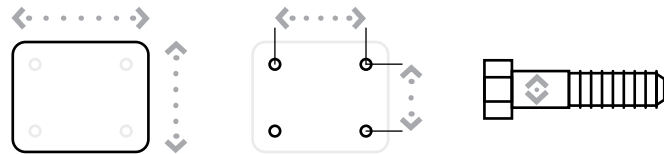

Top Plate Size	Bolt Hole Spacing	Bolt Diameter
Standard: 4.5" x 6.25"	2.433" x 4.933" Slotted to 3.37" x 5.25"	0.5"



CONVERSION DRIVE CASTER

TRIKE DRIVE CASTER

FEATURES

- Motor:** 24VDC Brushed Motor - 30 amp Current Draw.
- Speeds:** 2-5 mph depending on payload, wheel size and floor conditions.
- Power Options:** DC power (standard recommended option). AC power (only recommended for straight line movement).
- Steering:** Tank style steering.
- Wheels:** 8" x 2"
- Finish:** Powder coat (standard).

APPLICATIONS

The integrated caster and motor make it easy to add the Drive Caster® to your equipment, including dollies, moving walls, turntables, platforms, machinery and more.

BENEFITS

The Drive Caster® is another leading-edge innovation from Caster Concepts. The Drive Caster® is designed to move tons easily and efficiently, while offering the flexibility to integrate into a variety of applications beyond industrial carts and racks. This motor-driven caster is powered by a 1/2hp electric motor that can move up to 5,000 lbs. total weight per caster. Add another Drive Caster® and double the weight you're moving.

OPTIONS

- POWER OPTIONS**
- DC Power
 - AC Power

- CONVERSION SYSTEMS**
- Conversion Drive Caster
 - Trike Drive Caster.....

*Minimal speed adjustment on standard product.
Standard Drive Casters™ are non-towable.
Towing options available upon request.
Mounting adapters available.*

MOTOR POWERED DRIVE CASTER®

1/2 HP DRIVE CASTER® SPECIFICATIONS

Diameter	Width	Material	OAH	Duty Cycle	Width	Length	Weight
8	2.00	Polyurethane (70A)	10.13	20% (May Vary)	11.00	16.50	35.00

BATTERY SPECIFICATIONS

Battery Type	Battery Life	Standard Battery Charge Time	Rapid Charging Station Charge Time
Sealed Lead Acid Gel	3 - 4 Hours of Total Use	8 - 10 Hours	3 - 4 Hours (Includes Additional Set of Batteries)

PERFORMANCE SPECIFICATIONS

Max Load Capacity	Max Towing Capacity	Max Peak Torque	Total Torque	Speed
2,000	5,000	1,000 in-lbs.	Max 250 in-lbs.	1 - 2 mph

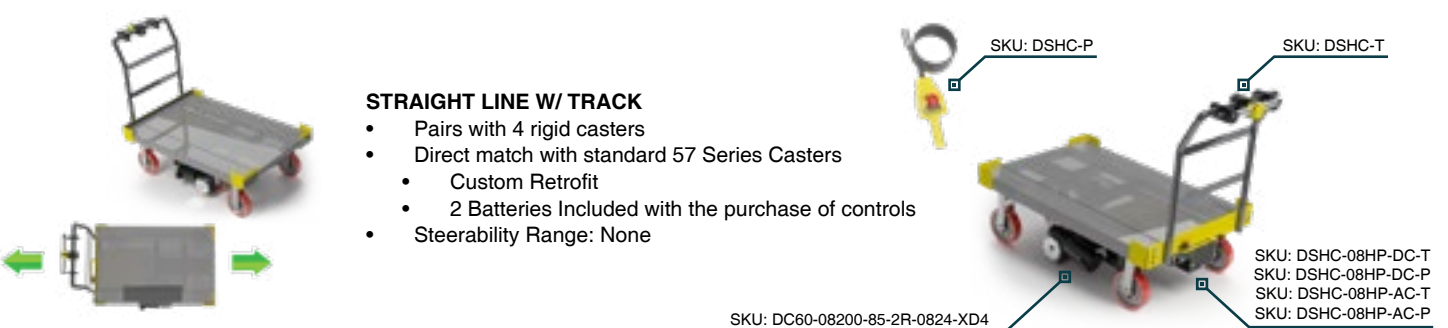
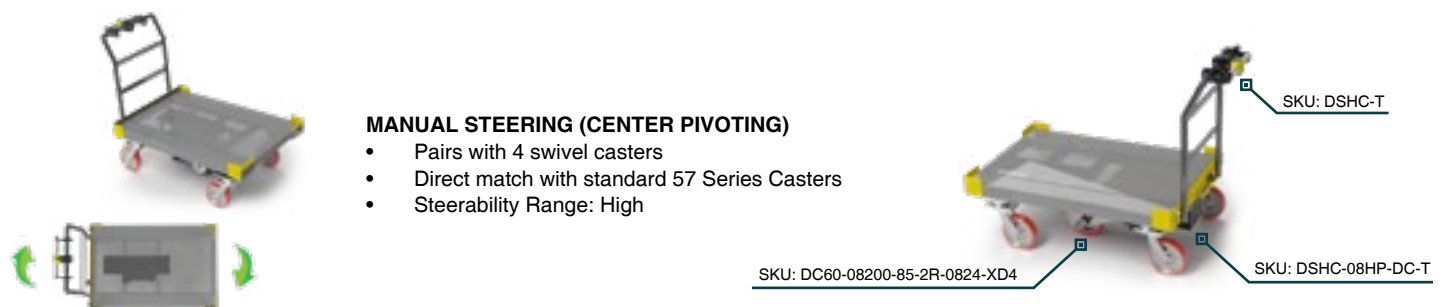
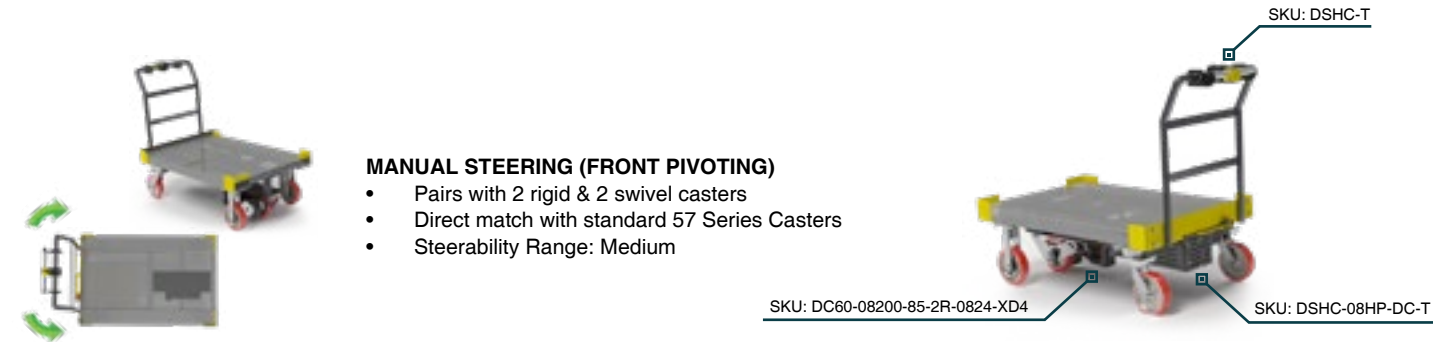

** Speeds: Depend on payload, wheel size and floor conditions
All dimensions are in inches. All weights are in pounds.
Standard Drive Casters™ are non-load bearing.*

KINGPINLESS STYLE TWERGO® XTREME



MAXIMUM CAPACITY

3,500 lbs.

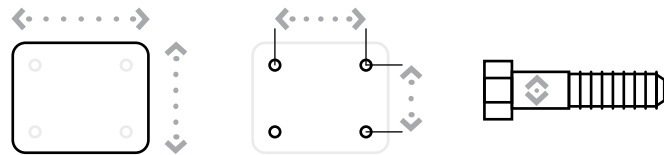

Top Plate Size	Bolt Hole Spacing	Bolt Diameter
57 Series Standard: 4.25" x 6.25"	2.438" x 4.938" Slotted to 3.375" x 5.25"	0.5"
77 Series Standard: 5" x 7.25"	3.375" x 5.25" Slotted to 4.125" x 6.125"	0.5"
Optional Top Plate 70: 5" x 7.25"	3.375" x 5.25" Slotted to 4.125" x 6.125"	0.5"



FEATURES

Swivel Section: Sealed dual row ball bearings.

57 Series Legs: 1/4 inch x 2 inch laser cut from mild steel, CNC formed and continuously welded on the inside and outside of the yoke base.

77 Series Legs: 3/8 inch x 2.75 inch laser cut from mild steel, CNC formed and continuously welded on the inside and outside of the yoke base.

Kingpin: Kingpinless style design.

Axle: 3/4 inch diameter, zinc plated, fine threads.

Lubrication: Sealed ball bearing is lubricated and requires zero maintenance.

Wheel Diameter: 6" to 12" diameter wheels are available with sealed precision ball bearings.

Finish: Clear zinc plating.

APPLICATIONS

Aerospace tooling, tire tread tray carts, automotive battery carts, etc.

BENEFITS

Safely move up to 3,500 pounds with one person. The TWERGO® wheel design allows for load to be spread out while reducing scrubbing while maneuvering.

OPTIONS

BRAKES

Face Contact: F
Poly Lock: P

SWIVEL LOCKS

Factory Installed: L
Demountable: DL

* For wheels with a diameter > 6"
^ Only available on roller bearing wheels.

KINGPINLESS STYLE TWERGO® XTREME

PRECISION BALL BEARING

Diameter	Width	Material	Capacity	OAH	Swivel Radius	Swivel Lead	Part Number	Weight
6	2.00	T/R Polyurethane	1,500	8.31	7.52	3.50	2-57TM-06202-93-1	15.75
6	2.00	T/R-95 Polyurethane	1,500	8.31	7.52	3.50	2-57TM-06202-94-1	15.75
6	2.00	ErgoTread	1,500	8.31	7.52	3.50	2-57TM-06202-44-1	15.75
6	3.00	T/R Polyurethane	3,280	8.50	8.46	3.50	2-77TM-06302-93-1	23.23
6	3.00	T/R-95 Polyurethane	3,500	8.50	8.46	3.50	2-77TM-06302-94-1	23.23
6	3.00	ErgoTread	3,120	8.50	8.46	3.50	2-77TM-06302-44-1	23.23
8	2.00	T/R Polyurethane	1,500	10.13	8.40	3.50	2-57TM-08202-93-1	18.97
8	2.00	T/R-95 Polyurethane	1,500	10.13	8.40	3.50	2-57TM-08202-94-1	18.97
8	2.00	ErgoTread	1,500	10.13	8.40	3.50	2-57TM-08202-44-1	18.97
8	3.00	T/R Polyurethane	3,500	10.50	9.25	3.50	2-77TM-08302-93-1	28.16
8	3.00	T/R-95 Polyurethane	3,500	10.50	9.25	3.50	2-77TM-08302-94-1	28.16
8	3.00	ErgoTread	3,500	10.50	9.25	3.50	2-77TM-08302-44-1	28.16
10	2.00	T/R Polyurethane	1,500	12.50	9.30	3.50	2-57TM-10202-93-1	22.08
10	2.00	T/R-95 Polyurethane	1,500	12.50	9.30	3.50	2-57TM-10202-94-1	22.08
10	2.00	ErgoTread	1,500	12.50	9.30	3.50	2-57TM-10202-44-1	22.08
10	3.00	T/R Polyurethane	3,500	12.50	10.07	3.50	2-77TM-10302-93-1	32.75
10	3.00	T/R-95 Polyurethane	3,500	12.50	10.07	3.50	2-77TM-10302-94-1	32.75
10	3.00	ErgoTread	3,500	12.50	10.07	3.50	2-77TM-10302-44-1	32.75
12	3.00	T/R Polyurethane	3,500	15.50	10.93	3.50	2-77TM-12302-93-1	53.97
12	3.00	T/R-95 Polyurethane	3,500	15.50	10.93	3.50	2-77TM-12302-94-1	53.97
12	3.00	ErgoTread	3,500	15.50	10.93	3.50	2-77TM-12302-44-1	53.97

Capacity listed is for manual operation. For powered operations, consult factory.
Part Numbers listed are for the swivel casters. For rigid casters, change the last digit from 1 to 2 (i.e. 2-77TM-06302-44-2)
Estimated weight is for swivel caster. Deduct 20 percent of swivel caster weight for rigid casters.
All dimensions are in inches. All weights are in pounds.

KINGPINLESS STYLE HERCULES



MAXIMUM CAPACITY
1,500 lbs.

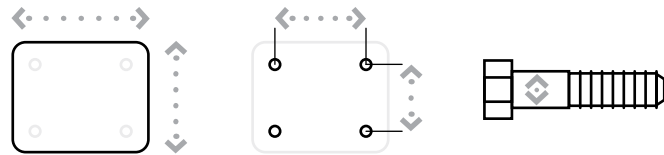

Top Plate Size	Bolt Hole Spacing	Bolt Diameter
55 Series Standard: 4" x 5"	2.625" x 3.625" Slotted to 3" x 3"	0.375"
57 Series Standard: 4.5" x 6.25"	2.438" x 4.938" Slotted to 3.375" x 5.25"	0.5"
Optional Top Plate 70: 5" x 7.25"	3.375" x 5.25" Slotted to 4.125" x 6.125"	0.5"



FEATURES

- Swivel Section:** Sealed precision ball bearing with hardened raceways and neoprene seals.
- Legs:** 3/8" x 3-1/4" steel, formed with C-channel design, and continuously welded on the inside and outside to the yoke base. Rigid caster legs are not formed and have angle iron for reinforcement.
- Kingpin:** Kingpinless style design.
- Axle:** 3/4" diameter.
- Lubrication:** Sealed ball bearing is lubricated and requires zero maintenance.
- Wheels:** 6" to 10" diameter wheels are available with sealed precision ball bearings.
- Finish:** Clear zinc plating.

APPLICATIONS

Excellent for abusive applications where side loading is currently causing issues with bent casters. Automotive plants, line side delivery carts, any heavy-duty manufacturing where downtime and maintenance costs are issues. Maintenance-free swivel section prolongs life of caster with improved ergonomics.

BENEFITS

Hercules casters are maintenance free with their sealed precision ball bearing in the swivel section and in the wheels. The smooth rotating action and extended lead help lower ergonomic forces. The legs are reinforced to protect against severe side loading for fork lifts and track channels. Prolonged life in extremely abusive applications reduces downtime and maintenance costs.

OPTIONS

SWIVEL LOCKS
 Factory Installed: L
 Demountable: DL

* For wheels with a diameter > 6"

KINGPINLESS STYLE HERCULES

PRECISION BALL BEARING

Diameter	Width	Material	Capacity	OAH	Swivel Radius	Swivel Lead	Part Number	Weight
6	2.00	T/R Polyurethane	960	8.00	5.10	2.00	55XRL-06202-61-1	19.08
6	2.00	HPPT Polyurethane	1,000	8.00	5.10	2.00	55XRL-06202-90-1	19.08
6	2.00	T/R-95 Polyurethane	1,000	8.00	5.10	2.00	55XRL-06202-91-1	19.08
6	2.00	T/R Polyurethane	960	8.00	5.10	2.00	55XRL-06202-93-1	15.53
6	2.00	T/R-95 Polyurethane	1,000	8.00	5.10	2.00	55XRL-06202-94-1	15.53
6	2.00	ErgoTread	910	8.00	5.10	2.00	55XRL-06202-44-1	15.53
6	2.00	T/R Polyurethane	960	8.50	5.84	2.75	57XRL-06202-61-1	22.15
6	2.00	HPPT Polyurethane	1,500	8.50	5.84	2.75	57XRL-06202-90-1	22.15
6	2.00	T/R-95 Polyurethane	1,400	8.50	5.84	2.75	57XRL-06202-91-1	22.15
6	2.00	ErgoTread	910	8.50	5.84	2.75	57XRL-06202-44-1	18.62
6	2.00	T/R Polyurethane	960	8.50	5.84	2.75	57XRL-06202-93-1	18.62
6	2.00	T/R-95 Polyurethane	1,400	8.50	5.84	2.75	57XRL-06202-94-1	18.62
8	2.00	T/R Polyurethane	1,000	10.13	6.08	2.00	55XRL-08202-61-1	25.92
8	2.00	HPPT Polyurethane	1,000	10.13	6.08	2.00	55XRL-08202-90-1	25.92
8	2.00	T/R-95 Polyurethane	1,000	10.13	6.08	2.00	55XRL-08202-91-1	25.92
8	2.00	T/R Polyurethane	1,000	10.13	6.08	2.00	55XRL-08202-93-1	18.19
8	2.00	T/R-95 Polyurethane	1,000	10.13	6.08	2.00	55XRL-08202-94-1	18.19
8	2.00	ErgoTread	1,000	10.13	6.08	2.00	55XRL-08202-44-1	18.19
8	2.00	T/R Polyurethane	1,240	10.50	6.82	2.75	57XRL-08202-61-1	28.94
8	2.00	HPPT Polyurethane	1,500	10.50	6.82	2.75	57XRL-08202-90-1	28.94
8	2.00	T/R-95 Polyurethane	1,500	10.50	6.82	2.75	57XRL-08202-91-1	28.94
8	2.00	ErgoTread	1,180	10.50	6.82	2.75	57XRL-08202-44-1	21.21
8	2.00	T/R Polyurethane	1,240	10.50	6.82	2.75	57XRL-08202-93-1	21.21
8	2.00	T/R-95 Polyurethane	1,500	10.50	6.82	2.75	57XRL-08202-94-1	21.21
10	2.00	T/R Polyurethane	1,000	12.00	7.07	2.00	55XRL-10202-93-1	20.47
10	2.00	T/R-95 Polyurethane	1,000	12.00	7.07	2.00	55XRL-10202-94-1	20.47
10	2.00	ErgoTread	1,000	12.00	7.07	2.00	55XRL-10202-44-1	20.47
10	2.00	T/R Polyurethane	1,500	12.50	8.06	3.00	57XRL-10202-93-1	23.68
10	2.00	T/R-95 Polyurethane	1,500	12.50	8.06	3.00	57XRL-10202-94-1	23.68
10	2.00	ErgoTread	1,500	12.50	8.06	3.00	57XRL-10202-44-1	23.68

Capacity listed is for manual operation. For powered operations, consult factory.
 Part Numbers listed are for the swivel caster. For rigid casters, change series to 50XRL and change the last digit from 1 to 2 (i.e. 50XRL-08202-61-2).
 Estimated weight is for swivel caster. Deduct 20 percent of swivel caster weight for rigid casters.
 All dimensions are in inches. All weights are in pounds.

KINGPINLESS STYLE 112 SWIVEL ON SWIVEL (SoS)



FEATURES

Swivel Section: Sealed precision ball bearing with hardened raceways and neoprene seals.

Legs: 1/4" x 2" steel, formed and continuously welded on the inside and outside of the yoke base.

Kingpin: Kingpinless style design.

Axle: 1/2" diameter.

Lubrication: Sealed ball bearing is lubricated and requires zero maintenance.

Wheels: 6" to 10" diameter wheels are available with sealed precision ball bearings.

Finish: Clear zinc plating.

APPLICATIONS

Excellent for production racks and fixtures, parts bins, conveyor systems, and other applications where maintenance-free casters and ergonomics are concerns. Also works well for carts and Automated Guided Vehicles that need to maneuver in tight spaces.

BENEFITS

The 112 series dual swivel section is maintenance free with its sealed precision ball bearing in the swivel section and in the wheels. The dual swivel action reduces castering effect, making it possible for a cart to go forwards and back in a straight line. This improves maneuverability in tight spaces and help reduce ergonomic push/pull forces.

OPTIONS

- BRAKES**
- Cam: C^
 - Poly Lock: P*
 - Face Contact: F
- TOE GUARD:** TG

* For wheels with a diameter > 6"
^ Not for use on TWERGO® Wheels.

MAXIMUM CAPACITY

1,500 lbs.

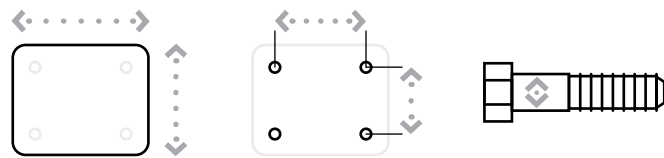

Top Plate Size	Bolt Hole Spacing	Bolt Diameter
Standard: 4.5" x 6.25"	2.438" x 4.938" Slotted to 3.375" x 5.25"	0.5"
Optional Top Plate 70: 5" x 7.25"	3.375" x 5.25" Slotted to 4.125" x 6.125"	0.5"

112 SERIES TOP PLATE

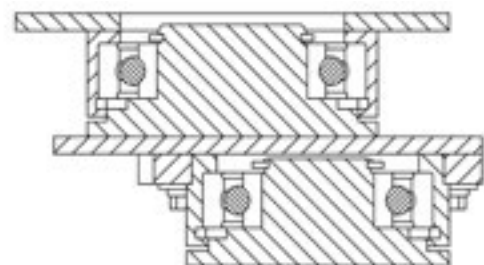

KINGPINLESS STYLE 112 SWIVEL ON SWIVEL (SoS)

PRECISION BALL BEARING

Diameter	Width	Material	Capacity	OAH	Swivel Radius	Swivel Lead	Part Number	Weight
6	2.00	ErgoTread	910	9.88	7.32	4.25	112-06202-40-1	22.30
6	2.00	T/R Polyurethane	960	9.88	7.32	4.25	112-06202-61-1	22.30
6	2.00	T/R-95 Polyurethane	1,400	9.88	7.32	4.25	112-06202-91-1	22.30
6	2.00	HPPT Polyurethane	1,500	9.88	7.32	4.25	112-06202-90-1	22.30
6	2.00	ErgoTread	910	9.88	7.32	4.25	112-06202-44-1	22.30
6	2.00	T/R Polyurethane	960	9.88	7.32	4.25	112-06202-93-1	22.30
6	2.00	T/R-95 Polyurethane	1,400	9.88	7.32	4.25	112-06202-94-1	22.30
8	2.00	ErgoTread	1,178	12.50	8.31	4.25	112-08202-40-1	26.30
8	2.00	T/R Polyurethane	1,240	12.50	8.31	4.25	112-08202-61-1	26.30
8	2.00	T/R-95 Polyurethane	1,500	12.50	8.31	4.25	112-08202-91-1	26.30
8	2.00	HPPT Polyurethane	1,500	12.50	8.31	4.25	112-08202-90-1	26.30
8	2.00	ErgoTread	1,180	12.50	8.31	4.25	112-08202-44-1	26.30
8	2.00	T/R Polyurethane	1,240	12.50	8.31	4.25	112-08202-93-1	26.30
8	2.00	T/R-95 Polyurethane	1,500	12.50	8.31	4.25	112-08202-94-1	26.30
10	2.00	T/R Polyurethane	1,500	13.88	9.30	4.25	112-10202-61-1	30.30
10	2.00	T/R-95 Polyurethane	1,500	13.88	9.30	4.25	112-10202-91-1	30.30
10	2.00	ErgoTread	1,500	13.88	9.30	4.25	112-10202-44-1	30.30
10	2.00	T/R Polyurethane	1,500	13.88	9.30	4.25	112-10202-93-1	30.30
10	2.00	T/R-95 Polyurethane	1,500	13.88	9.30	4.25	112-10202-94-1	30.30

Capacity listed is for manual operation. For powered operations, consult factory.
All dimensions are in inches. All weights are in pounds.

KINGPINLESS STYLE 134 SWIVEL ON SWIVEL (SoS)



FEATURES

- Swivel Section:** Sealed precision ball bearing with hardened raceways and neoprene seals.
- Legs:** 1/4" x 2" steel, formed and continuously welded on the inside and outside of the yoke base.
- Kingpin:** Kingpinless style design.
- Axle:** 1/2" diameter.
- Lubrication:** Sealed ball bearing is lubricated and requires zero maintenance.
- Wheels:** 6" to 10" diameter wheels are available with sealed precision ball bearings.
- Finish:** Clear zinc plating.

APPLICATIONS

Excellent for production racks and fixtures, parts bins, conveyor systems, and other applications where maintenance-free casters and ergonomics are concerns. Also works well for carts and Automated Guided Vehicles that need to maneuver in tight spaces.

BENEFITS

The 134 series dual swivel section is maintenance free with its sealed precision ball bearing in the swivel section and in the wheels. The dual swivel action reduces castering effect, making it possible for a cart to go forwards and back in a straight line. This improves maneuverability in tight spaces and help reduce ergonomic push/pull forces.

OPTIONS

- BRAKES**
- Cam: C^
 - Poly Lock: P*
 - Face Contact: F
- TOE GUARD:** TG

* For wheels with a diameter > 6"
^ Not for use on TWERGO® Wheels.

MAXIMUM CAPACITY

2,500 lbs.

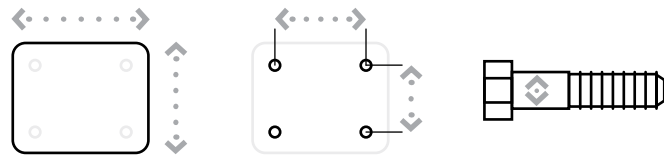

Top Plate Size	Bolt Hole Spacing	Bolt Diameter
Standard: 5" x 7.25"	3.375" x 5.25" Slotted to 4.125" x 6.125"	0.5"

134 SERIES TOP PLATE

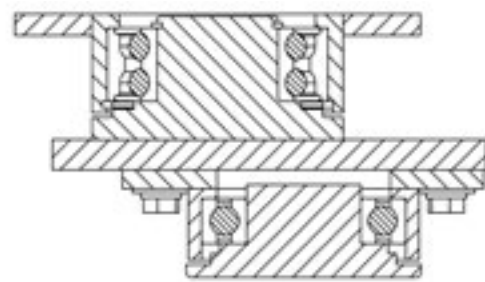

KINGPINLESS STYLE 134 SWIVEL ON SWIVEL (SoS)

PRECISION BALL BEARING

Diameter	Width	Material	Capacity	OAH	Swivel Radius	Swivel Lead	Part Number	Weight
6	2.00	ErgoTread	910	11.06	7.32	4.25	134-06202-40-1	27.70
6	2.00	ErgoTread	910	11.06	7.32	4.25	134-06202-44-1	24.90
6	2.00	T/R Polyurethane	960	11.06	7.32	4.25	134-06202-61-1	27.70
6	2.00	T/R-95 Polyurethane	1,400	11.06	7.32	4.25	134-06202-91-1	27.70
6	2.00	T/R Polyurethane	960	11.06	7.32	4.25	134-06202-93-1	24.90
6	2.00	T/R-95 Polyurethane	1,400	11.06	7.32	4.25	134-06202-94-1	24.90
8	2.00	ErgoTread	1,178	12.75	8.56	4.50	134-08202-40-1	30.50
8	2.00	ErgoTread	1,180	12.75	8.56	4.50	134-08202-44-1	26.60
8	2.00	T/R Polyurethane	1,240	12.75	8.56	4.50	134-08202-61-1	30.50
8	2.00	T/R-95 Polyurethane	1,800	12.75	8.56	4.50	134-08202-91-1	30.50
8	2.00	T/R Polyurethane	1,240	12.75	8.56	4.50	134-08202-93-1	26.60
8	2.00	T/R-95 Polyurethane	1,800	12.75	8.56	4.50	134-08202-94-1	26.60
10	2.00	ErgoTread	2,185	15.25	9.55	4.50	134-10202-40-1	28.50
10	2.00	ErgoTread	1,520	15.25	9.55	4.50	134-10202-44-1	28.30
10	2.00	T/R Polyurethane	2,300	15.25	9.55	4.50	134-10202-61-1	28.50
10	2.00	T/R-95 Polyurethane	1,800	15.25	9.55	4.50	134-10202-91-1	28.50
10	2.00	T/R Polyurethane	1,600	15.25	9.55	4.50	134-10202-93-1	28.30
10	2.00	T/R-95 Polyurethane	2,500	15.25	9.55	4.50	134-10202-94-1	28.30

Capacity listed is for manual operation. For powered operations, consult factory.
All dimensions are in inches. All weights are in pounds.

KINGPINLESS STYLE 154 SWIVEL ON SWIVEL (SoS)



FEATURES

Swivel Section: Sealed precision ball bearing with hardened raceways and neoprene seals.

Legs: 3/8" x 2-3/4" steel, formed and continuously welded on the inside and outside of the yoke base.

Kingpin: Kingpinless style design.

Axle: 3/4" diameter.

Lubrication: Sealed ball bearing is lubricated and requires zero maintenance.

Wheels: 6" to 12" diameter wheels are available with sealed precision ball bearings.

Finish: Clear zinc plating.

APPLICATIONS

Excellent for production racks and fixtures, parts bins, conveyor systems, and other applications where maintenance-free casters and ergonomics are concerns. Also works well for carts and Automated Guided Vehicles that need to maneuver in tight spaces.

BENEFITS

The 154 series dual swivel section is maintenance free with its sealed precision ball bearing in the swivel section and in the wheels. The dual swivel action reduces castering effect, making it possible for a cart to go forwards and back in a straight line. This improves maneuverability in tight spaces and help reduce ergonomic push/pull forces.

OPTIONS

BRAKES

Poly Lock: P*
Face Contact: F

TOE GUARD: TG

* For wheels with a diameter > 6"

KINGPINLESS STYLE 154 SWIVEL ON SWIVEL (SoS)

PRECISION BALL BEARING

Diameter	Width	Material	Capacity	OAH	Swivel Radius	Swivel Lead	Part Number	Weight
6	3.00	ErgoTread	1,560	11.25	8.14	5.00	154-06302-40-1	39.80
6	3.00	ErgoTread	1,560	11.25	8.14	5.00	154-06302-44-1	31.80
6	3.00	T/R Polyurethane	1,640	11.25	8.14	5.00	154-06302-61-1	39.80
6	3.00	HPPT Polyurethane	2,300	11.25	8.14	5.00	154-06302-90-1	39.80
6	3.00	T/R-95 Polyurethane	2,070	11.25	8.14	5.00	154-06302-91-1	39.80
6	3.00	T/R Polyurethane	1,640	11.25	8.14	5.00	154-06302-93-1	31.80
6	3.00	T/R-95 Polyurethane	2,070	11.25	8.14	5.00	154-06302-94-1	31.80
8	3.00	ErgoTread	1,900	13.25	9.12	5.00	154-08302-40-1	44.30
8	3.00	ErgoTread	1,900	13.25	9.12	5.00	154-08302-44-1	34.40
8	3.00	T/R Polyurethane	2,000	13.25	9.12	5.00	154-08302-61-1	44.30
8	3.00	HPPT Polyurethane	3,100	13.25	9.12	5.00	154-08302-90-1	44.30
8	3.00	T/R-95 Polyurethane	2,800	13.25	9.12	5.00	154-08302-91-1	44.30
8	3.00	T/R Polyurethane	2,000	13.25	9.12	5.00	154-08302-93-1	34.40
8	3.00	T/R-95 Polyurethane	2,800	13.25	9.12	5.00	154-08302-94-1	34.40
10	3.00	ErgoTread	2,280	15.25	10.11	5.00	154-10302-40-1	50.40
10	3.00	ErgoTread	2,280	15.25	10.11	5.00	154-10302-44-1	36.90
10	3.00	T/R Polyurethane	2,400	15.25	10.11	5.00	154-10302-61-1	50.40
10	3.00	HPPT Polyurethane	3,450	15.25	10.11	5.00	154-10302-90-1	50.40
10	3.00	T/R-95 Polyurethane	3,100	15.25	10.11	5.00	154-10302-91-1	50.40
10	3.00	T/R Polyurethane	2,400	15.25	10.11	5.00	154-10302-93-1	36.90
10	3.00	T/R-95 Polyurethane	3,100	15.25	10.11	5.00	154-10302-94-1	36.90
12	3.00	ErgoTread	2,660	18.25	11.10	5.00	154-12302-40-1	58.10
12	3.00	ErgoTread	2,660	18.25	11.10	5.00	154-12302-44-1	40.50
12	3.00	T/R Polyurethane	2,800	18.25	11.10	5.00	154-12302-61-1	58.10
12	3.00	HPPT Polyurethane	3,500	18.25	11.10	5.00	154-12302-90-1	58.10
12	3.00	T/R-95 Polyurethane	3,400	18.25	11.10	5.00	154-12302-91-1	58.10
12	3.00	T/R Polyurethane	2,800	18.25	11.10	5.00	154-12302-93-1	40.50
12	3.00	T/R-95 Polyurethane	3,400	18.25	11.10	5.00	154-12302-94-1	40.50

MAXIMUM CAPACITY

3,500 lbs.

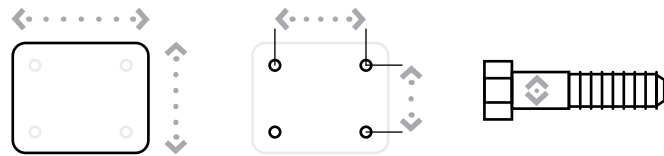

Top Plate Size	Bolt Hole Spacing	Bolt Diameter
Standard: 5" x 7.25"	3.375" x 5.25" Slotted to 4.125" x 6.125"	0.5"

154 SERIES TOP PLATE

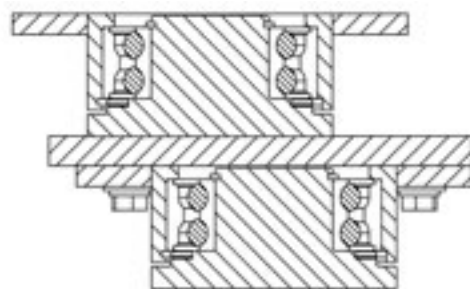

Capacity listed is for manual operation. For powered operations, consult factory.
All dimensions are in inches. All weights are in pounds.

NOISE REDUCING CasterShoX®



FEATURES

Swivel Section: Available in a standard kingpinless style swivel (55 Series) or a maintenance-free kingpinless style swivel (57 Series).

Legs: 1/4" x 2" steel, formed and continuously welded on the inside and outside to the yoke base.

Wheels: 6" to 8" diameter wheels are available with sealed precision ball bearings.

Finish: Clear zinc plating.

APPLICATIONS

CasterShoX® casters are ideal for instances where workplace safety relating to hearing conservation is a concern. CasterShoX® casters have the ability to reduce workplace noise levels by as much as 15 dBA. In addition, CasterShoX® casters work great for transporting fragile components, or meeting ergonomic requirements.

BENEFITS

CasterShoX® integrates a shock absorption unit into the center of the caster wheel, addressing the shock at the source, virtually eliminating noise and vibration instantly. The patented Shock Absorption unit is very different from traditional metal coiled springs, which continue to expand and contract continuously until shock is fully dissipated, CasterShoX® work like shock absorbers on a vehicle and stop the vibration quickly.

OPTIONS

BRAKES

Poly Lock: P*
Face Contact: F

SWIVEL LOCKS

Factory Installed: L
Demountable: DL
Foot Actuated: KL
Passive: PL

TOE GUARD TG

* For wheels with a diameter > 6"
^ Only available on roller bearing wheels.

NOISE REDUCING CasterShoX®

PRECISION BALL BEARING (55 SERIES)

Diameter	Width	Material	Capacity	OAH	Swivel Radius	Swivel Lead	Part Number	Core Series	Weight
6	2.00	T/R Polyurethane	1,000	8.00	6.08	3.00	55-06202-61-1XD9	9	9.57
6	2.00	T/R Polyurethane	750	8.00	6.08	3.00	55-06202-61-1XD8	8	9.57
6	2.00	T/R Polyurethane	400	8.00	6.08	3.00	55-06202-61-1XD7	7	9.57
6	2.00	T/R Polyurethane	200	8.00	6.08	3.00	55-06202-61-1XD6	6	9.57
6	2.00	T/R-95 Polyurethane	1,000	8.00	6.08	3.00	55-06202-91-1XD9	9	9.57
6	2.00	T/R-95 Polyurethane	750	8.00	6.08	3.00	55-06202-91-1XD8	8	9.57
6	2.00	T/R-95 Polyurethane	400	8.00	6.08	3.00	55-06202-91-1XD7	7	9.57
6	2.00	T/R-95 Polyurethane	200	8.00	6.08	3.00	55-06202-91-1XD6	6	9.57
6	2.00	HPPT Polyurethane	1,000	8.00	6.08	3.00	55-06202-90-1XD9	9	9.57
6	2.00	HPPT Polyurethane	750	8.00	6.08	3.00	55-06202-90-1XD8	8	9.57
6	2.00	HPPT Polyurethane	400	8.00	6.08	3.00	55-06202-90-1XD7	7	9.57
6	2.00	HPPT Polyurethane	200	8.00	6.08	3.00	55-06202-90-1XD6	6	9.57
8	2.00	T/R Polyurethane	1,000	10.13	7.07	3.00	55-08202-61-1XD9	9	12.58
8	2.00	T/R Polyurethane	750	10.13	7.07	3.00	55-08202-61-1XD8	8	12.58
8	2.00	T/R Polyurethane	400	10.13	7.07	3.00	55-08202-61-1XD7	7	12.58
8	2.00	T/R Polyurethane	200	10.13	7.07	3.00	55-08202-61-1XD6	6	12.58
8	2.00	T/R-95 Polyurethane	1,000	10.13	7.07	3.00	55-08202-91-1XD9	9	12.58
8	2.00	T/R-95 Polyurethane	750	10.13	7.07	3.00	55-08202-91-1XD8	8	12.58
8	2.00	T/R-95 Polyurethane	400	10.13	7.07	3.00	55-08202-91-1XD7	7	12.58
8	2.00	T/R-95 Polyurethane	200	10.13	7.07	3.00	55-08202-91-1XD6	6	12.58
8	2.00	HPPT Polyurethane	1,000	10.13	7.07	3.00	55-08202-90-1XD9	9	12.58
8	2.00	HPPT Polyurethane	750	10.13	7.07	3.00	55-08202-90-1XD8	8	12.58
8	2.00	HPPT Polyurethane	400	10.13	7.07	3.00	55-08202-90-1XD7	7	12.58
8	2.00	HPPT Polyurethane	200	10.13	7.07	3.00	55-08202-90-1XD6	6	12.58
8	2.00	ErgoTread	950	10.13	7.07	3.00	55-08202-43-1XD9	9	12.58
8	2.00	ErgoTread	750	10.13	7.07	3.00	55-08202-43-1XD8	8	12.58
8	2.00	ErgoTread	400	10.13	7.07	3.00	55-08202-43-1XD7	7	12.58
8	2.00	ErgoTread	200	10.13	7.07	3.00	55-08202-43-1XD6	6	12.58
8	2.00	T/R Polyurethane	1,000	10.13	7.07	3.00	55-08202-51-1XD9	9	12.58
8	2.00	T/R Polyurethane	750	10.13	7.07	3.00	55-08202-51-1XD8	8	12.58
8	2.00	T/R Polyurethane	400	10.13	7.07	3.00	55-08202-51-1XD7	7	12.58
8	2.00	T/R Polyurethane	200	10.13	7.07	3.00	55-08202-51-1XD6	6	12.58
8	2.00	T/R-95 Polyurethane	1,000	10.13	7.07	3.00	55-08202-56-1XD9	9	12.58
8	2.00	T/R-95 Polyurethane	750	10.13	7.07	3.00	55-08202-56-1XD8	8	12.58
8	2.00	T/R-95 Polyurethane	400	10.13	7.07	3.00	55-08202-56-1XD7	7	12.58
8	2.00	T/R-95 Polyurethane	200	10.13	7.07	3.00	55-08202-56-1XD6	6	12.58

Capacity listed is for manual operation. For powered operations, consult factory.
Part Numbers listed are for the swivel casters.
For rigid casters, change the last digit from 1 to 2 (i.e. 50-08202-61-2XD7 or 57-08202-61-2XD7)
Estimated weight is for swivel caster. Deduct 20 percent of swivel caster weight for rigid casters.
All dimensions are in inches. All weights are in pounds.

CONTINUED

MAXIMUM CAPACITY

1,000 lbs.

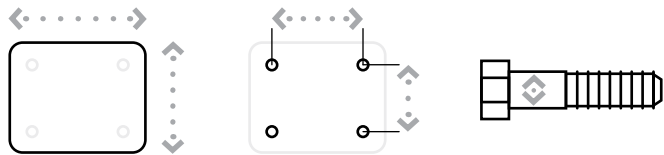

55 SERIES TOP PLATE

Top Plate Size	Bolt Hole Spacing	Bolt Diameter
Standard: 4" x 5"	2.625" x 3.625" Slotted to 3" x 3"	0.375"
Optional Top Plate 30: 4" x 4.5"	2.625" x 3.625" Slotted to 3" x 3"	0.375"
Optional Top Plate 60: 4.5" x 6.25"	2.438" x 4.938" Slotted to 3.375" x 5.25"	0.5"
Optional Top Plate 70: 5" x 7.25"	3.375" x 5.25" Slotted to 4.125" x 6.125"	0.5"

57 SERIES TOP PLATE

Top Plate Size	Bolt Hole Spacing	Bolt Diameter
Standard: 4.5" x 6.25"	2.438" x 4.938" Slotted to 3.375" x 5.25"	0.5"
Optional Top Plate 70: 5" x 7.25"	3.375" x 5.25" Slotted to 4.125" x 6.125"	0.5"

NOISE REDUCING CasterShoX®

PRECISION BALL BEARING (57 SERIES)

Diameter	Width	Material	Capacity	OAH	Swivel Radius	Swivel Lead	Part Number	Core Series	Weight
6	2.00	T/R Polyurethane	1,000	8.50	5.84	2.75	57-06202-61-1XD9	9	11.57
6	2.00	T/R Polyurethane	750	8.50	5.84	2.75	57-06202-61-1XD8	8	11.57
6	2.00	T/R Polyurethane	400	8.50	5.84	2.75	57-06202-61-1XD7	7	11.57
6	2.00	T/R Polyurethane	200	8.50	5.84	2.75	57-06202-61-1XD6	6	11.57
6	2.00	T/R-95 Polyurethane	1,000	8.50	5.84	2.75	57-06202-91-1XD9	9	11.57
6	2.00	T/R-95 Polyurethane	750	8.50	5.84	2.75	57-06202-91-1XD8	8	11.57
6	2.00	T/R-95 Polyurethane	400	8.50	5.84	2.75	57-06202-91-1XD7	7	11.57
6	2.00	T/R-95 Polyurethane	200	8.50	5.84	2.75	57-06202-91-1XD6	6	11.57
6	2.00	HPPT Polyurethane	1,000	8.50	5.84	2.75	57-06202-90-1XD9	9	11.57
6	2.00	HPPT Polyurethane	750	8.50	5.84	2.75	57-06202-90-1XD8	8	11.57
6	2.00	HPPT Polyurethane	400	8.50	5.84	2.75	57-06202-90-1XD7	7	11.57
6	2.00	HPPT Polyurethane	200	8.50	5.84	2.75	57-06202-90-1XD6	6	11.57
8	2.00	T/R Polyurethane	1,000	10.50	6.82	2.75	57-08202-61-1XD9	9	15.30
8	2.00	T/R Polyurethane	750	10.50	6.82	2.75	57-08202-61-1XD8	8	15.30
8	2.00	T/R Polyurethane	400	10.50	6.82	2.75	57-08202-61-1XD7	7	15.30
8	2.00	T/R Polyurethane	200	10.50	6.82	2.75	57-08202-61-1XD6	6	15.30
8	2.00	T/R-95 Polyurethane	1,000	10.50	6.82	2.75	57-08202-91-1XD9	9	15.30
8	2.00	T/R-95 Polyurethane	750	10.50	6.82	2.75	57-08202-91-1XD8	8	15.30
8	2.00	T/R-95 Polyurethane	400	10.50	6.82	2.75	57-08202-91-1XD7	7	15.30
8	2.00	T/R-95 Polyurethane	200	10.50	6.82	2.75	57-08202-91-1XD6	6	15.30
8	2.00	HPPT Polyurethane	1,000	10.50	6.82	2.75	57-08202-90-1XD9	9	15.30
8	2.00	HPPT Polyurethane	750	10.50	6.82	2.75	57-08202-90-1XD8	8	15.30
8	2.00	HPPT Polyurethane	400	10.50	6.82	2.75	57-08202-90-1XD7	7	15.30
8	2.00	HPPT Polyurethane	200	10.50	6.82	2.75	57-08202-90-1XD6	6	15.30

Capacity listed is for manual operation. For powered operations, consult factory.

Part Numbers listed are for the swivel casters.

For rigid casters, change the last digit from 1 to 2 (i.e. 50-08202-61-2XD7 or 57-08202-61-2XD7)

Estimated weight is for swivel caster. Deduct 20 percent of swivel caster weight for rigid casters.

All dimensions are in inches. All weights are in pounds.



MEDIUM DUTY 30 SERIES CASTERS

MEDIUM DUTY 30 SERIES



MAXIMUM CAPACITY

900 lbs.

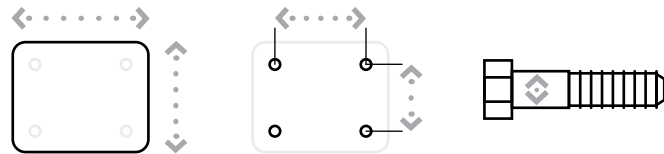

Top Plate Size	Bolt Hole Spacing	Bolt Diameter
Standard: 4" x 4.5"	2.625" x 3.625" Slotted to 3" x 3"	0.375"
Optional Top Plate 35: 5" x 5.5"	4.12" x 4.5"	0.375"

30 SERIES TOP PLATE

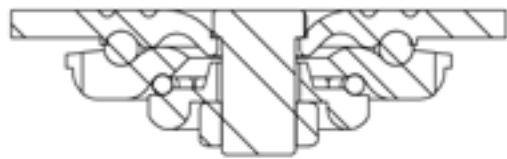

FEATURES

Swivel Section: Cold forged out of 1/4" steel, the swivel section includes high-strength double row ball bearings in smooth raceways.

Legs: 1/4" steel formed for strength.

Kingpin: 5/8" diameter kingpin.

Axle: 1/2" diameter.

Lubrication: Pre-lubricated before shipping.

Wheels: 4" to 8" diameter wheels are available with straight roller bearings or ball bearings for ease in rolling.

Finish: Zinc plated for corrosion resistance.

APPLICATIONS

Excellent for dollies, waste disposal trucks, warehouse trucks, proof or cooling racks, portable work benches, floor trucks, shop carts, drywall dollies, trailer frames, wire shelving units, tool boxes, laundry distribution carts, manual lifting devices, unitized dairy distribution carts and other medium duty applications.

BENEFITS

The 30 Series is constructed of cold forged steel and is recommended for medium duty applications.

OPTIONS

BRAKES

Cam: C*

SWIVEL LOCKS

Factory Installed: L
Demountable: DL

SEALED WHEELS: SW

* For wheels with a diameter > 6"

MEDIUM DUTY 30 SERIES

STRAIGHT ROLLER BEARING

Diameter	Width	Material	Capacity	OAH	Swivel Lead	Part Number	Weight
4	1.50	Forged Steel	900	5.63	1.38	30-04101-20-1	6.00
4	2.00	Phenolic Resin	700	5.63	1.38	30-04201-30-1	6.50
4	2.00	Standard Polyurethane	750	5.63	1.38	30-04201-60-1	7.50
4	2.00	H.D. T/R Polyurethane	600	5.63	1.38	30-04201-66-1	7.50
5	2.00	Forged Steel	900	6.50	1.69	30-05201-20-1	8.00
5	2.00	Phenolic Resin	900	6.50	1.69	30-05201-30-1	7.00
5	2.00	Standard Polyurethane	900	6.50	1.69	30-05201-60-1	9.00
5	2.00	T/R Polyurethane	800	6.50	1.69	30-05201-61-1	8.00
6	2.00	Forged Steel	900	7.50	2.00	30-06201-20-1	10.00
6	2.00	Phenolic Resin	900	7.50	2.00	30-06201-30-1	8.00
6	2.00	Standard Polyurethane	900	7.50	2.00	30-06201-60-1	10.00
6	2.00	T/R Polyurethane	900	7.50	2.00	30-06201-61-1	9.00
8	2.00	Phenolic Resin	900	9.50	2.38	30-08201-30-1	9.00
8	2.00	Polyurethane	900	9.50	2.38	30-08201-60-1	10.00
8	2.00	Soft Polyurethane	900	9.50	2.38	30-08201-61-1	9.00

PRECISION BALL BEARING

Diameter	Width	Material	Capacity	OAH	Swivel Lead	Part Number	Weight
4	2.00	H.D. T/R Polyurethane	600	5.63	1.38	30-04202-66-1	7.50
5	2.00	T/R Polyurethane	800	6.50	1.69	30-05202-61-1	8.00
6	2.00	Standard Polyurethane	900	7.50	2.00	30-06202-60-1	10.00
6	2.00	T/R Polyurethane	900	7.50	2.00	30-06202-61-1	9.00
8	2.00	Polyurethane	900	9.50	2.38	30-08202-60-1	10.00
8	2.00	Soft Polyurethane	900	9.50	2.38	30-08202-61-1	9.00

Capacity listed is for manual operation. For powered operations, consult factory.

Part numbers listed are for the swivel caster.

For rigid casters, change the last digit from 1 to 2 (i.e. 30-06201-30-2).

Estimated weight is for the swivel caster. Deduct 20% of swivel caster weight for rigid caster.

* These casters have annular ball bearings.

All dimensions are in inches. All weights are in pounds.

KINGPINLESS STYLE 51 SERIES



MAXIMUM CAPACITY

1,500 lbs.

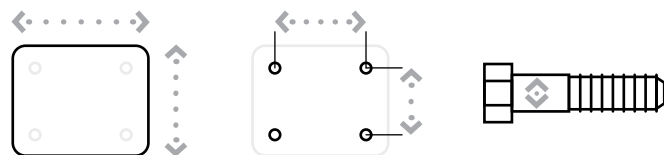

Top Plate Size	Bolt Hole Spacing	Bolt Diameter
Standard: 4" x 5"	2.625" x 3.625" Slotted to 3" x 3"	0.375"
Optional Top Plate 60: 4.5" x 6.25"	2.438" x 4.938" Slotted to 3.375" x 5.25"	0.5"
Optional Top Plate 70: 5" x 7.25"	3.375" x 5.25" Slotted to 4.125" x 6.125"	0.5"
Optional Top Plate 75: 6" x 7"	4.62 x 5.5	0.5"

51 SERIES TOP PLATE

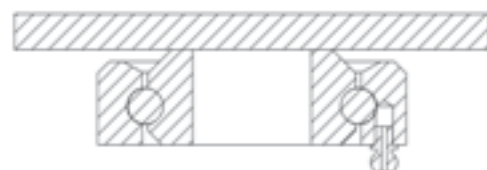

FEATURES

Swivel Section: High alloy swivel section is precision machined to accommodate 3/8" diameter ball bearings. Swivel sections are through hardened for durability.

Legs: 1/4" x 2" steel, formed and continuously welded inside and outside to the yoke base.

Axle: 1/2" diameter.

Lubrication: Pre-lubricated before shipping.

Wheels: 4" to 8" diameter wheels are available with straight roller bearings or ball bearings for ease in rolling.

Finish: Clear zinc plating.

Applications: Excellent for light powered applications, bakery dough troughs, portable work benches, platform trucks, tow lines, utility carts, tooling fixtures, scrap metal carriers, drywall dollies, gantry cranes, automated guided vehicles, fiberglass lay-up molds, and other applications.

APPLICATIONS

Excellent for light powered applications, bakery dough troughs, portable work benches, platform trucks, tow lines, utility carts, tooling fixtures, scrap metal carriers, drywall dollies, gantry cranes, automated guided vehicles, fiberglass lay-up molds, and other applications.

BENEFITS

The 51 Series kingpinless style swivel bearings act as both load and thrust components to lock the swivel section together and distribute the load over a larger area. The hardened swivel sections and formed and welded legs provide the strength and durability necessary for use in applications where constant swiveling under load is necessary.

OPTIONS

BRAKES

Cam: C*
 Poly Lock: P*
 Wrap Around: W^
 Dual Side: DS^
 Single Side: SS^
 Face Contact: F

SWIVEL LOCKS

Factory Installed: L
 Demountable: DL
 Foot Actuated: KL
 Passive: PL

SEALED SWIVEL SECTION SSW

SEALED WHEELS SW

TOE GUARD TG

* For wheels with a diameter > 6"
 ^ Only available on roller bearing wheels.

KINGPINLESS STYLE 51 SERIES

STRAIGHT ROLLER BEARING

Diameter	Width	Material	Capacity	OAH	Swivel Radius	Swivel Lead	Part Number	Weight
4	1.50	Forged Steel	1,400	5.62	3.58	1.50	51-04101-20-1	7.25
4	2.00	Phenolic Resin	800	5.62	3.64	1.50	51-04201-30-1	7.50
4	2.00	Cast Iron	1,000	5.62	3.64	1.50	51-04201-10-1	7.50
4	2.00	Standard Polyurethane	700	5.62	3.64	1.50	51-04201-60-1	7.50
4	2.00	H.D. T/R Polyurethane	600	5.62	3.64	1.50	51-04201-66-1	7.50
4	2.00	Mold On Rubber	350	5.62	3.64	1.50	51-04201-70-1	8.20
5	2.00	Forged Steel	1,500	6.50	4.37	1.75	51-05201-20-1	10.20
5	2.00	Cast Iron	1,200	6.50	4.37	1.75	51-05201-10-1	9.20
5	2.00	Phenolic Resin	1,000	6.50	4.37	1.75	51-05201-30-1	8.50
5	2.00	Standard Polyurethane	1,050	6.50	4.37	1.75	51-05201-60-1	10.00
5	2.00	T/R Polyurethane	850	6.50	4.37	1.75	51-05201-61-1	10.00
5	2.00	Mold On Rubber	400	6.50	4.37	1.75	51-05201-70-1	10.00
6	2.00	Forged Steel	1,500	7.50	5.34	2.25	51-06201-20-1	13.50
6	2.00	Cast Iron	1,200	7.50	5.34	2.25	51-06201-10-1	13.00
6	2.00	Phenolic Resin	1,200	7.50	5.34	2.25	51-06201-30-1	9.50
6	2.00	Standard Polyurethane	1,200	7.50	5.34	2.25	51-06201-60-1	12.00
6	2.00	T/R Polyurethane	1,000	7.50	5.34	2.25	51-06201-61-1	12.00
6	2.00	Mold On Rubber	425	7.50	5.34	2.25	51-06201-70-1	12.00
8	2.00	Cast Iron	1,500	10.12	6.33	2.25	51-08201-10-1	16.50
8	2.00	Phenolic Resin	1,400	10.12	6.33	2.25	51-08201-30-1	12.00
8	2.00	Standard Polyurethane	1,500	10.12	6.33	2.25	51-08201-60-1	14.00
8	2.00	T/R Polyurethane	1,200	10.12	6.33	2.25	51-08201-61-1	14.00
8	2.00	Mold On Rubber	500	10.12	6.33	2.25	51-08201-70-1	14.00

PRECISION BEARING

Diameter	Width	Material	Capacity	OAH	Swivel Radius	Swivel Lead	Part Number	Weight
4	1.50	Forged Steel	1,400	5.62	3.58	1.50	51-04109-20-1†	7.25
4	2.00	Standard Polyurethane	700	5.62	3.64	1.50	51-04204-60-1*	7.50
4	2.00	H.D. T/R Polyurethane	600	5.62	3.64	1.50	51-04202-66-1	7.50
5	2.00	Forged Steel	1,500	6.50	4.37	1.75	51-05209-20-1†	10.20
5	2.00	Standard Polyurethane	1,050	6.50	4.37	1.75	51-05202-60-1	10.00
5	2.00	T/R Polyurethane	850	6.50	4.37	1.75	51-05202-61-1	10.00
6	2.00	Forged Steel	1,500	7.50	5.34	2.25	51-06209-20-1†	13.50
6	2.00	Standard Polyurethane	1,200	7.50	5.34	2.25	51-06202-60-1	12.00
6	2.00	T/R Polyurethane	1,000	7.50	5.34	2.25	51-06202-61-1	12.00
8	2.00	Standard Polyurethane	1,500	10.12	6.33	2.25	51-08202-60-1	14.00
8	2.00	T/R Polyurethane	1,200	10.12	6.33	2.25	51-08202-61-1	14.00

Capacity listed for manual operation. For powered operations consult factory.
 Part numbers listed are for the swivel caster. For rigid casters, change series to 50 and change the last digit from 1 to 2 (ie: 50-06201-60-2).
 Estimated weight is for the swivel caster, deduct 20% of swivel caster weight for rigid caster.
 † This caster has tapered bearings. * This caster has annular ball bearings.
 All dimensions are in inches. All weights are in pounds.

KINGPINLESS STYLE 55 SERIES



FEATURES

- Swivel Section:** Sealed precision ball bearing with hardened raceways and neoprene seals.
- Legs:** 1/4" x 2" steel and continuously welded on the inside and outside of the yoke base.
- Kingpin:** Kingpinless style design.
- Axle:** 1/2" diameter.
- Lubrication:** Sealed ball bearing is lubricated and requires zero maintenance.
- Wheels:** 4" to 8" diameter wheels are available with sealed precision ball bearings.
- Finish:** Clear zinc plating.

APPLICATIONS

Excellent for production racks and fixtures, parts bins, conveyor systems, and other applications where maintenance-free casters and ergonomics are concerns.

BENEFITS

The 55 Series is maintenance free with its sealed precision ball bearing in the swivel section and in the wheels. The smooth rotation and extended lead help lower ergonomic forces.

OPTIONS

- BRAKES**
- Cam: C[^]
 - Poly Lock: P^{*}
 - Face Contact: F
- SWIVEL LOCKS**
- Factory Installed: L
 - Demountable: DL
 - Foot Actuated: KL
- TOE GUARD:** TG

^{*} For wheels with a diameter > 6"
[^] Not compatible with TWERGO® wheels

MAXIMUM CAPACITY

1,000 lbs.

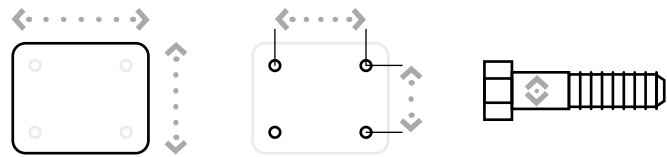

Top Plate Size	Bolt Hole Spacing	Bolt Diameter
Standard: 4" x 5"	2.625" x 3.625" Slotted to 3" x 3"	0.375"

55 SERIES TOP PLATE

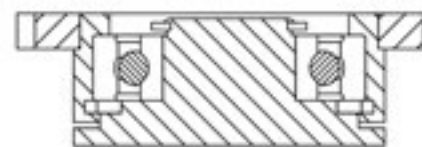

KINGPINLESS STYLE 55 SERIES

PRECISION BALL BEARING

Diameter	Width	Material	Capacity	OAH	Swivel Radius	Swivel Lead	Part Number	Weight
4	2.00	T/R Polyurethane	600	5.63	4.12	2.00	55-04204-61-1*	8.02
4	2.00	T/R-95 Polyurethane	1,000	5.63	4.12	2.00	55-04204-91-1*	8.02
4	2.00	HPPT Polyurethane	1,000	5.63	4.12	2.00	55-04204-90-1*	8.02
4	2.00	T/R Polyurethane	600	5.63	4.12	2.00	55-04202-93-1	8.02
4	2.00	T/R-95 Polyurethane	1,000	5.63	4.12	2.00	55-04202-94-1	8.02
4	2.00	ErgoTread	570	5.63	4.12	2.00	55-04202-44-1	8.02
5	2.00	T/R Polyurethane	840	6.50	4.61	2.00	55-05202-61-1	10.25
5	2.00	T/R-95 Polyurethane	1,000	6.50	4.61	2.00	55-05202-91-1	10.25
5	2.00	HPPT Polyurethane	1,000	6.50	4.61	2.00	55-05202-90-1	10.25
5	2.00	T/R Polyurethane	840	6.50	4.61	2.00	55-05202-93-1	7.70
5	2.00	T/R-95 Polyurethane	1,000	6.50	4.61	2.00	55-05202-94-1	7.70
5	2.00	ErgoTread	800	6.50	4.61	2.00	55-05202-44-1	7.70
6	2.00	T/R Polyurethane	960	7.50	5.10	2.00	55-06202-61-1	10.88
6	2.00	T/R-95 Polyurethane	1,000	7.50	5.10	2.00	55-06202-91-1	10.88
6	2.00	HPPT Polyurethane	1,000	7.50	5.10	2.00	55-06202-90-1	10.88
6	2.00	T/R Polyurethane	960	7.50	5.10	2.00	55-06202-93-1	8.25
6	2.00	T/R-95 Polyurethane	1,000	7.50	5.10	2.00	55-06202-94-1	8.25
6	2.00	ErgoTread	910	7.50	5.10	2.00	55-06202-44-1	8.25
8	2.00	T/R Polyurethane	1,000	10.13	6.08	2.00	55-08202-61-1	14.02
8	2.00	T/R-95 Polyurethane	1,000	10.13	6.08	2.00	55-08202-91-1	14.02
8	2.00	HPPT Polyurethane	1,000	10.13	6.08	2.00	55-08202-90-1	14.02
8	2.00	T/R Polyurethane	1,000	10.13	6.08	2.00	55-08202-93-1	10.10
8	2.00	T/R-95 Polyurethane	1,000	10.13	6.08	2.00	55-08202-94-1	10.10
8	2.00	ErgoTread	1,000	10.13	6.08	2.00	55-08202-44-1	10.10

Capacity listed is for manual operation. For powered operations, consult factory.
Part Numbers listed are for the swivel caster.
For rigid casters, change series to 50 and change the last digit from 1 to 2 (i.e. 50-08202-61-2).
Estimated weight is for swivel caster. Deduct 20 percent of swivel caster weight for rigid casters.
^{*} This caster has annular ball bearings
All dimensions are in inches. All weights are in pounds.

CONTINUED

KINGPINLESS STYLE 55 SERIES

PRECISION BEARING (Extended Swivel Lead Casters)

Diameter	Width	Material	Capacity	OAH	Swivel Radius	Swivel Lead	Part Number	Weight
4	2.00	T/R Polyurethane	600	5.63	5.34	3.25	55EXT-04204-61-1*	8.33
4	2.00	T/R-95 Polyurethane	1,000	5.63	5.34	3.25	55EXT-04204-91-1*	8.33
4	2.00	HPPT Polyurethane	1,000	5.63	5.34	3.25	55EXT-04204-90-1*	8.33
4	2.00	ErgoTread	570	5.63	5.34	3.25	55EXT-04204-44-1*	7.03
4	2.00	T/R Polyurethane	600	5.63	5.34	3.25	55EXT-04204-93-1*	7.03
4	2.00	T/R-95 Polyurethane	1,000	5.63	5.34	3.25	55EXT-04204-94-1*	7.03
5	2.00	T/R Polyurethane	840	6.50	5.84	3.25	55EXT-05202-61-1	10.54
5	2.00	T/R-95 Polyurethane	1,000	6.50	5.84	3.25	55EXT-05202-91-1	10.54
5	2.00	HPPT Polyurethane	1,000	6.50	5.84	3.25	55EXT-05202-90-1	10.54
5	2.00	ErgoTread	800	6.50	5.84	3.25	55EXT-05202-44-1	7.99
5	2.00	T/R Polyurethane	840	6.50	5.84	3.25	55EXT-05202-93-1	7.99
5	2.00	T/R-95 Polyurethane	1,000	6.50	5.84	3.25	55EXT-05202-94-1	7.99
6	2.00	T/R Polyurethane	960	7.50	6.33	3.25	55EXT-06202-61-1	11.14
6	2.00	T/R-95 Polyurethane	1,000	7.50	6.33	3.25	55EXT-06202-91-1	11.14
6	2.00	HPPT Polyurethane	1,000	7.50	6.33	3.25	55EXT-06202-90-1	11.14
6	2.00	ErgoTread	910	7.50	6.33	3.25	55EXT-06202-44-1	8.51
6	2.00	T/R Polyurethane	960	7.50	6.33	3.25	55EXT-06202-93-1	8.51
6	2.00	T/R-95 Polyurethane	1,000	7.50	6.33	3.25	55EXT-06202-94-1	8.51
8	2.00	T/R Polyurethane	1,000	10.13	7.32	3.25	55EXT-08202-61-1	14.23
8	2.00	T/R-95 Polyurethane	1,000	10.13	7.32	3.25	55EXT-08202-91-1	14.23
8	2.00	HPPT Polyurethane	1,000	10.13	7.32	3.25	55EXT-08202-90-1	14.23
8	2.00	ErgoTread	1,000	10.13	7.32	3.25	55EXT-08202-44-1	10.30
8	2.00	T/R Polyurethane	1,000	10.13	7.32	3.25	55EXT-08202-93-1	10.30
8	2.00	T/R-95 Polyurethane	1,000	10.13	7.32	3.25	55EXT-08202-94-1	10.30

Capacity listed is for manual operation. For powered operations, consult factory.

Part Numbers listed are for the swivel caster. For rigid casters, change series to 50 and change the last digit from 1 to 2 (i.e. 50-08202-61-2).

Estimated weight is for swivel caster. Deduct 20 percent of swivel caster weight for rigid casters.

* This caster has annular ball bearings

All dimensions are in inches. All weights are in pounds.



HEAVY DUTY 57 SERIES CASTERS

KINGPINLESS STYLE 57 SERIES



FEATURES

- Swivel Section:** Sealed precision ball bearing with hardened raceways and neoprene seals.
- Legs:** 1/4" x 2" steel and continuously welded on the inside and outside of the yoke base.
- Kingpin:** Kingpinless style design.
- Axle:** 1/2" diameter.
- Lubrication:** Sealed ball bearing is lubricated and requires zero maintenance.
- Wheels:** 6" to 10" diameter wheels are available with sealed precision ball bearings.
- Finish:** Clear zinc plating.

APPLICATIONS

Excellent for production racks and fixtures, parts bins, conveyor systems, and other applications where maintenance-free casters and ergonomics are concerns.

BENEFITS

The 57 Series is maintenance free with its sealed precision ball bearing in the swivel section and in the wheels. The smooth rotation and extended lead help lower ergonomic forces.

OPTIONS

- BRAKES**
- Cam: C[^]
 - Poly Lock: P^{*}
 - Face Contact: F
- SWIVEL LOCKS**
- Factory Installed: L
 - Demountable: DL
 - Foot Actuated: KL
- TOE GUARD:** TG

^{*} For wheels with a diameter > 6"
[^] Not compatible with TWERGO® wheels

MAXIMUM CAPACITY

1,500 lbs.

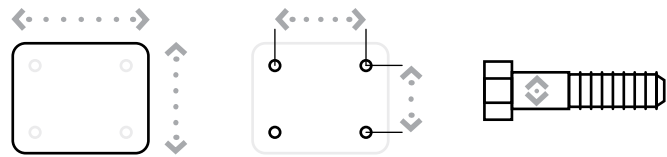

Top Plate Size	Bolt Hole Spacing	Bolt Diameter
Standard: 4.5" x 6.25"	2.438" x 4.938" Slotted to 3.375" x 5.25"	0.5"
Optional Top Plate 70: 5" x 7.25"	3.375" x 5.25" Slotted to 4.125" x 6.125"	0.5"

57 SERIES TOP PLATE



KINGPINLESS STYLE 57 SERIES

PRECISION BALL BEARING

Diameter	Width	Material	Capacity	OAH	Swivel Radius	Swivel Lead	Part Number	Weight
6	2.00	T/R Polyurethane	960	8.31	5.84	2.75	57-06202-61-1	12.00
6	2.00	ErgoTread	760	8.31	5.84	2.75	57-06202-43-1	12.00
6	2.00	T/R-95 Polyurethane	1,400	8.31	5.84	2.75	57-06202-91-1	12.00
6	2.00	Standard Polyurethane	1,000	8.31	5.84	2.75	57-06202-50-1	12.00
6	2.00	T/R Polyurethane	800	8.31	5.84	2.75	57-06202-51-1	12.00
6	2.00	Hard Polyurethane (70D)	1,000	8.31	5.84	2.75	57-06202-53-1	12.00
6	2.00	T/R-95 Polyurethane	1,100	8.31	5.84	2.75	57-06202-56-1	12.00
6	2.00	HPPT Polyurethane	1,500	8.31	5.84	2.75	57-06202-90-1	12.00
6	2.00	T/R Polyurethane	960	8.31	5.84	2.75	57-06202-93-1	12.00
6	2.00	T/R-95 Polyurethane	1,400	8.31	5.84	2.75	57-06202-94-1	12.00
6	2.00	ErgoTread	910	8.31	5.84	2.75	57-06202-44-1	12.00
8	2.00	T/R Polyurethane	1,240	10.13	6.82	2.75	57-08202-61-1	16.00
8	2.00	ErgoTread	760	10.13	6.82	2.75	57-08202-43-1	16.00
8	2.00	T/R-95 Polyurethane	1,500	10.13	6.82	2.75	57-08202-91-1	16.00
8	2.00	Standard Polyurethane	1,000	10.13	6.82	2.75	57-08202-50-1	16.00
8	2.00	T/R Polyurethane	800	10.13	6.82	2.75	57-08202-51-1	16.00
8	2.00	Hard Polyurethane (70D)	1,000	10.13	6.82	2.75	57-08202-53-1	16.00
8	2.00	T/R-95 Polyurethane	1,100	10.13	6.82	2.75	57-08202-56-1	16.00
8	2.00	HPPT Polyurethane	1,500	10.13	6.82	2.75	57-08202-90-1	16.00
8	2.00	T/R Polyurethane	1,240	10.13	6.82	2.75	57-08202-93-1	16.00
8	2.00	T/R-95 Polyurethane	1,500	10.13	6.82	2.75	57-08202-94-1	16.00
8	2.00	ErgoTread	1,180	10.13	6.82	2.75	57-08202-44-1	16.00
10	2.00	T/R Polyurethane	1,500	12.50	8.06	3.00	57-10202-93-1	14.67
10	2.00	ErgoTread	1,500	12.50	8.06	3.00	57-10202-44-1	14.67
10	2.00	T/R-95 Polyurethane	1,500	12.50	8.06	3.00	57-10202-94-1	14.67
10	2.00	T/R Polyurethane	1,400	12.50	8.06	3.00	57-10202-46-1	14.67
10	2.00	ErgoTread	1,500	12.50	8.06	3.00	57-10202-42-1	14.67
10	2.00	T/R-95 Polyurethane	1,500	12.50	8.06	3.00	57-10202-47-1	14.67

Capacity listed is for manual operation. For powered operations, consult factory.
Part Numbers listed are for the swivel caster.
For rigid casters, change the last digit from 1 to 2 (i.e. 57-08202-60-2).
Estimated weight is for swivel caster. Deduct 20 percent of swivel caster weight for rigid casters.
All dimensions are in inches. All weights are in pounds.

CONTINUED

KINGPINLESS STYLE 57 SERIES

PRECISION BEARING (Extended Swivel Lead Casters)

Diameter	Width	Material	Capacity	OAH	Swivel Radius	Swivel Lead	Part Number	Weight
6	2.00	T/R Polyurethane	960	8.31	6.58	3.50	57EXT-06202-61-1	14.07
6	2.00	T/R-95 Polyurethane	1,200	8.31	6.58	3.50	57EXT-06202-91-1	14.07
6	2.00	HPPT Polyurethane	1,200	8.31	6.58	3.50	57EXT-06202-90-1	14.07
6	2.00	ErgoTread	910	8.31	6.58	3.50	57EXT-06202-44-1	11.20
6	2.00	T/R Polyurethane	960	8.31	6.58	3.50	57EXT-06202-93-1	11.20
6	2.00	T/R-95 Polyurethane	1,400	8.31	6.58	3.50	57EXT-06202-94-1	11.20
8	2.00	T/R Polyurethane	1,200	10.13	7.57	3.50	57EXT-08202-61-1	16.94
8	2.00	T/R-95 Polyurethane	1,200	10.13	7.57	3.50	57EXT-08202-91-1	16.94
8	2.00	HPPT Polyurethane	1,200	10.13	7.57	3.50	57EXT-08202-90-1	16.94
8	2.00	ErgoTread	1,180	10.13	7.57	3.50	57EXT-08202-44-1	13.11
8	2.00	T/R Polyurethane	1,240	10.13	7.57	3.50	57EXT-08202-93-1	13.11
8	2.00	T/R-95 Polyurethane	1,500	10.13	7.57	3.50	57EXT-08202-94-1	13.11
10	2.00	T/R Polyurethane	1,500	12.50	8.56	3.50	57EXT-10202-61-1	14.75
10	2.00	T/R-95 Polyurethane	1,500	12.50	8.56	3.50	57EXT-10202-91-1	14.75
10	2.00	ErgoTread	1,500	12.50	8.56	3.50	57EXT-10202-44-1	14.75
10	2.00	T/R Polyurethane	1,500	12.50	8.56	3.50	57EXT-10202-93-1	14.75
10	2.00	T/R-95 Polyurethane	1,500	12.50	8.56	3.50	57EXT-10202-94-1	14.75

Capacity listed is for manual operation. For powered operations, consult factory.

Part Numbers listed are for the swivel caster.

For rigid casters, change the last digit from 1 to 2 (i.e. 57-08202-60-2).

Estimated weight is for swivel caster. Deduct 20 percent of swivel caster weight for rigid casters.

All dimensions are in inches. All weights are in pounds.



HEAVY DUTY 61 SERIES CASTERS

KINGPINLESS STYLE 61 SERIES



FEATURES

Swivel Section: A high alloy steel swivel section features a precision machined and through hardened 3-1/4" diameter raceway with 1/2" inch ball bearings.

Legs: 5/16" x 2-1/2" legs are formed and continuously welded inside and outside to the yoke base.

Kingpin: Kingpinless style design.

Axle: 3/4" diameter.

Lubrication: Pre-lubricated before shipping.

Wheels: 4" to 12" diameter wheels are available.

Finish: Clear zinc plating.

APPLICATIONS

Excellent for light powered applications, bakery dough troughs, portable work benches, platform trucks, tow lines, utility carts, tooling fixtures, scrap metal carriers, drywall dollies, gantry cranes, automated guided vehicles, fiberglass lay-up molds, and other applications.

BENEFITS

The 61 Series kingpinless style swivel bearings act as both load and thrust components and lock the swivel section together to distribute the load over a larger area. The single ball race design provides easy maneuverability and longevity under high load situations.

OPTIONS

BRAKES

Cam: C*
 Poly Lock: P*
 Wrap Around: W*
 Dual Side: DS
 Single Side: SS
 Face Contact: F

SWIVEL LOCKS

Factory Installed: L
 Demountable: DL
 Foot Actuated: KL
 Passive: PL

SEALED SWIVEL SECTION SSW

SEALED WHEELS SW

TOE GUARD TG

* For wheels with a diameter > 6"
 ^ Only available on roller bearing wheels.

KINGPINLESS STYLE 61 SERIES

STRAIGHT ROLLER BEARING

Diameter	Width	Material	Capacity	OAH	Swivel Radius	Swivel Lead	Part Number	Weight
4	3.00	Cast Iron	2,000	5.62	3.81	1.50	61-04301-10-1	18.00
4	3.25	Standard Polyurethane	1,200	5.62	3.86	1.50	61-04321-60-1	16.00
5	2.50	Cast Iron	2,000	6.50	4.43	1.75	61-05251-10-1	20.00
5	2.50	Standard Polyurethane	1,325	6.50	4.43	1.75	61-05251-60-1	20.00
5	3.00	Standard Polyurethane	1,550	6.50	4.51	1.75	61-05301-60-1	22.00
6	2.50	Cast Iron	2,500	7.50	5.40	2.25	61-06251-10-1	22.50
6	2.50	Forged Steel	3,500	7.50	5.40	2.25	61-06251-20-1	22.00
6	2.50	Phenolic Resin	1,600	7.50	5.40	2.25	61-06251-30-1	14.50
6	2.50	Standard Polyurethane	1,625	7.50	5.40	2.25	61-06251-60-1	26.00
6	2.50	Mold On Rubber	550	7.50	5.40	2.25	61-06251-70-1	24.00
6	3.00	Cast Iron	2,500	7.50	5.46	2.25	61-06301-10-1	23.00
6	3.00	Phenolic Resin	2,000	7.50	5.46	2.25	61-06301-30-1	17.00
6	3.00	Standard Polyurethane	2,050	7.50	5.46	2.25	61-06301-60-1	15.00
6	3.00	H.D. Standard Polyurethane	2,450	7.50	5.46	2.25	61-06301-65-1	14.50
6	3.00	Mold On Rubber	675	7.50	5.46	2.25	61-06301-70-1	23.00
8	2.50	Phenolic Resin	2,000	10.12	6.37	2.25	61-08251-30-1	17.00
8	2.50	Standard Polyurethane	2,050	10.12	6.37	2.25	61-08251-60-1	23.00
8	2.50	H.D. T/R Polyurethane	1,640	10.12	6.37	2.25	61-08251-66-1	25.00
8	2.50	Mold On Rubber	670	10.12	6.37	2.25	61-08251-70-1	19.00
8	3.00	Forged Steel	3,500	10.12	6.43	2.25	61-08301-20-1	29.00
8	3.00	Cast Iron	3,500	10.12	6.43	2.25	61-08301-10-1	39.00
8	3.00	Phenolic Resin	2,500	10.12	6.43	2.25	61-08301-30-1	19.00
8	3.00	Standard Polyurethane	2,520	10.12	6.43	2.25	61-08301-60-1	27.00
8	3.00	H.D. Standard Polyurethane	3,100	10.12	6.43	2.25	61-08301-65-1	25.00
8	3.00	H.D. T/R Polyurethane	2,500	10.12	6.43	2.25	61-08301-66-1	25.00
8	3.00	Mold On Rubber	840	10.12	6.43	2.25	61-08301-70-1	24.00
10	3.00	Cast Iron	3,500	11.50	8.14	3.00	61-10301-10-1	42.00
10	3.00	Phenolic Resin	2,900	11.50	8.14	3.00	61-10301-30-1	21.00
10	3.00	Standard Polyurethane	3,000	11.50	8.14	3.00	61-10301-60-1	32.00
10	3.00	H.D. Standard Polyurethane	3,500	11.50	8.14	3.00	61-10301-65-1	37.00
10	3.00	H.D. T/R Polyurethane	2,750	11.50	8.14	3.00	61-10301-66-1	37.00
10	3.00	Mold On Rubber	1,000	11.50	8.14	3.00	61-10301-70-1	37.00
12	3.00	Phenolic Resin	3,500	13.50	9.12	3.00	61-12301-30-1	30.00
12	3.00	Standard Polyurethane	3,500	13.50	9.12	3.00	61-12301-60-1	41.00
12	3.00	Mold On Rubber	1,125	13.50	9.12	3.00	61-12301-70-1	32.00

Capacity listed is for manual operation. For powered operations, consult factory.
 Part Numbers listed are for the swivel caster.

For rigid casters, change series to 65 and change the last digit from 1 to 2 (i.e. 65-10309-60-2).

Estimated weight is for swivel caster. Deduct 20 percent of swivel caster weight for rigid casters.

*These casters have precision ball bearings.

All dimensions are in inches. All weights are in pounds.

CONTINUED

MAXIMUM CAPACITY
3,500 lbs.

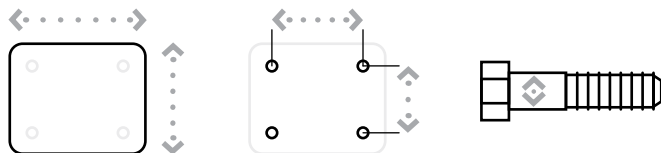

Top Plate Size	Bolt Hole Spacing	Bolt Diameter
Standard: 4.5" x 6.25"	2.438" x 4.938" Slotted to 3.375" x 5.25"	0.5"
Optional Top Plate 70: 5" x 7.25"	3.375" x 5.25" Slotted to 4.125" x 6.125"	0.5"
Optional Top Plate 75: 6" x 7"	4.625" x 5.5"	0.5"
Optional Top Plate 80: 6" x 7.5"	4.5" x 6"	0.5"

Note: OT 80 will increase OAH by 1/8"

61 SERIES TOP PLATE

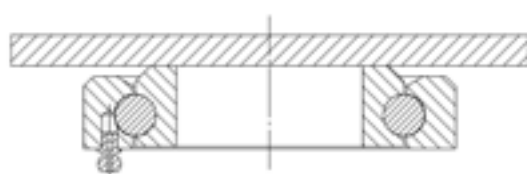

KINGPINLESS STYLE 61 SERIES

PRECISION BEARING

Diameter	Width	Material	Capacity	OAH	Swivel Radius	Swivel Lead	Part Number	Weight
4	3.00	Cast Iron	2,000	5.62	3.81	1.50	61-04309-10-1	18.00
4	3.25	Standard Polyurethane	1,200	5.62	3.86	1.50	61-04329-60-1	16.00
5	2.50	Cast Iron	2,000	6.50	4.43	1.75	61-05259-10-1	20.00
5	2.50	Standard Polyurethane	1,325	6.50	4.43	1.75	61-05259-60-1	20.00
5	3.00	Standard Polyurethane	1,550	6.50	4.51	1.75	61-05309-60-1	22.00
6	2.50	Cast Iron	2,500	7.50	5.40	2.25	61-06259-10-1	22.50
6	2.50	Forged Steel	3,500	7.50	5.40	2.25	61-06259-20-1	22.00
6	2.50	Phenolic Resin	1,600	7.50	5.40	2.25	61-06259-30-1	14.50
6	2.50	Standard Polyurethane	1,625	7.50	5.40	2.25	61-06259-60-1	26.00
6	2.50	Mold On Rubber	550	7.50	5.40	2.25	61-06259-70-1	24.00
6	3.00	Cast Iron	2,500	7.50	5.46	2.25	61-06309-10-1	23.00
6	3.00	Phenolic Resin	2,000	7.50	5.46	2.25	61-06309-30-1	17.00
6	3.00	Standard Polyurethane	2,050	7.50	5.46	2.25	61-06309-60-1	15.00
6	3.00	H.D. Standard Polyurethane	2,450	7.50	5.46	2.25	61-06309-65-1	14.50
6	3.00	T/R Polyurethane	1,640	7.50	5.46	2.25	61-06302-61-1*	14.50
6	3.00	Mold On Rubber	675	7.50	5.46	2.25	61-06309-70-1	23.00
8	2.50	Phenolic Resin	2,000	10.12	6.37	2.25	61-08259-30-1	17.00
8	2.50	Standard Polyurethane	2,050	10.12	6.37	2.25	61-08259-60-1	23.00
8	2.50	H.D. T/R Polyurethane	1,640	10.12	6.37	2.25	61-08259-66-1	25.00
8	2.50	Mold On Rubber	670	10.12	6.37	2.25	61-08259-70-1	19.00
8	3.00	Forged Steel	3,500	10.12	6.43	2.25	61-08309-20-1	29.00
8	3.00	Cast Iron	3,500	10.12	6.43	2.25	61-08309-10-1	39.00
8	3.00	Phenolic Resin	2,500	10.12	6.43	2.25	61-08309-30-1	19.00
8	3.00	Standard Polyurethane	2,520	10.12	6.43	2.25	61-08309-60-1	27.00
8	3.00	T/R Polyurethane	2,000	10.12	6.43	2.25	61-08302-61-1*	27.00
8	3.00	H.D. Standard Polyurethane	3,100	10.12	6.43	2.25	61-08309-65-1	25.00
8	3.00	H.D. T/R Polyurethane	2,500	10.12	6.43	2.25	61-08309-66-1	25.00
8	3.00	Mold On Rubber	840	10.12	6.43	2.25	61-08309-70-1	24.00
10	3.00	Cast Iron	3,500	11.50	8.14	3.00	61-10309-10-1	42.00
10	3.00	Phenolic Resin	2,900	11.50	8.14	3.00	61-10309-30-1	21.00
10	3.00	Standard Polyurethane	3,000	11.50	8.14	3.00	61-10309-60-1	32.00
10	3.00	T/R Polyurethane	2,400	11.50	8.14	3.00	61-10302-61-1*	32.00
10	3.00	H.D. Standard Polyurethane	3,500	11.50	8.14	3.00	61-10309-65-1	37.00
10	3.00	H.D. T/R Polyurethane	2,750	11.50	8.14	3.00	61-10309-66-1	37.00
10	3.00	Mold On Rubber	1,000	11.50	8.14	3.00	61-10309-70-1	37.00
12	3.00	Phenolic Resin	3,500	13.50	9.12	3.00	61-12309-30-1	30.00
12	3.00	Standard Polyurethane	3,500	13.50	9.12	3.00	61-12309-60-1	41.00
12	3.00	Mold On Rubber	1,125	13.50	9.12	3.00	61-12309-70-1	32.00

Capacity listed is for manual operation. For powered operations, consult factory.

Part Numbers listed are for the swivel caster. For rigid casters, change series to 65 and change the last digit from 1 to 2 (i.e. 65-10309-60-2).

Estimated weight is for swivel caster. Deduct 20 percent of swivel caster weight for rigid casters.

*These casters have precision ball bearings.

All dimensions are in inches. All weights are in pounds.



HEAVY DUTY 71 SERIES CASTERS



KINGPINLESS STYLE 71 SERIES



FEATURES

Swivel Section: High alloy steel swivel section features a precision machined and through hardened 3-1/4" diameter raceway.

Legs: 5/16" x 3" legs are formed and continuously welded inside and outside to the yoke base.

Kingpin: Kingpinless style design.

Axle: 3/4" bolt and locking nut.

Lubrication: Pre-lubricated before shipping.

Wheels: 4" to 12" wheels are available.

Finish: Clear zinc plating.

APPLICATIONS

Suited for medium duty towing applications where shock loads are present. In addition, they may be used for dough troughs, high capacity die tables, machinery dollies, corrugated steel box trucks, heavy portable storage racks, mobile military equipment, aircraft maintenance stands, and aircraft crew stairs.

BENEFITS

The 71 Series is our heaviest offering in the fabricated single ball race caster. These swivel bearings act as both load and thrust components and lock the swivel section together to distribute the load over a larger area. Because of the unique fabrication of the swivel section, various top plate options can be utilized.

OPTIONS

BRAKES

Poly Lock: P*
 Wrap Around: W*
 Dual Side: DS
 Single Side: SS
 Face Contact: F

SWIVEL LOCKS

Factory Installed: L
 Demountable: DL
 Foot Actuated: KL
 Passive: PL

SEALED SWIVEL SECTION SSW

SEALED WHEELS SW

TOE GUARD TG

* For wheels with a diameter > 6"
 ^ Only available on roller bearing wheels.

KINGPINLESS STYLE 71 SERIES

STRAIGHT ROLLER BEARING

Diameter	Width	Material	Capacity	OAH	Swivel Radius	Swivel Lead	Part Number	Weight
4	3.00	Cast Iron	2,000	6.00	4.27	2.00	71-04301-10-1	20.00
4	3.25	Standard Polyurethane	1,200	6.00	4.32	2.00	71-04321-60-1	17.00
5	2.50	Cast Iron	2,000	7.00	4.91	2.25	71-05251-10-1	24.00
5	3.00	Standard Polyurethane	1,550	7.00	4.98	2.25	71-05301-60-1	23.00
6	2.50	Cast Iron	2,500	8.00	5.40	2.25	71-06251-10-1	27.00
6	2.50	Forged Steel	4,000	8.00	5.40	2.25	71-06251-20-1	25.00
6	3.00	Cast Iron	2,500	8.00	5.46	2.25	71-06301-10-1	25.00
6	3.00	Phenolic Resin	2,000	8.00	5.46	2.25	71-06301-30-1	19.00
6	3.00	Standard Polyurethane	2,050	8.00	5.46	2.25	71-06301-60-1	21.00
6	3.00	H.D. Standard Polyurethane	2,450	8.00	5.46	2.25	71-06301-65-1	23.00
6	3.00	H.D. T/R Polyurethane	2,050	8.00	5.46	2.25	71-06301-66-1	23.00
6	3.00	Mold On Rubber	675	8.00	5.46	2.25	71-06301-70-1	24.00
8	3.00	Cast Iron	3,500	10.50	6.67	2.50	71-08301-10-1	34.00
8	3.00	Forged Steel	4,500	10.50	6.67	2.50	71-08301-20-1	34.00
8	3.00	Phenolic Resin	2,500	10.50	6.67	2.50	71-08301-30-1	22.00
8	3.00	Standard Polyurethane	2,500	10.50	6.67	2.50	71-08301-60-1	30.00
8	3.00	H.D. Standard Polyurethane	3,100	10.50	6.67	2.50	71-08301-65-1	34.00
8	3.00	H.D. T/R Polyurethane	2,500	10.50	6.67	2.50	71-08301-66-1	34.00
8	3.00	Mold On Rubber	840	10.50	6.67	2.50	71-08301-70-1	27.00
10	3.00	Cast Iron	3,500	12.50	8.14	3.00	71-10301-10-1	40.00
10	3.00	Forged Steel	4,500	12.50	8.14	3.00	71-10301-20-1	43.00
10	3.00	Phenolic Resin	2,900	12.50	8.14	3.00	71-10301-30-1	25.00
10	3.00	Standard Polyurethane	3,000	12.50	8.14	3.00	71-10301-60-1	35.00
10	3.00	H.D. Standard Polyurethane	3,500	12.50	8.14	3.00	71-10301-65-1	40.00
10	3.00	H.D. T/R Polyurethane	2,750	12.50	8.14	3.00	71-10301-66-1	40.00
12	3.00	Phenolic Resin	3,500	15.50	9.12	3.00	71-12301-30-1	30.00
12	3.00	Standard Polyurethane	3,500	15.50	9.12	3.00	71-12301-60-1	25.00
12	3.00	Mold On Rubber	1,125	15.50	9.12	3.00	71-12301-70-1	25.00

MAXIMUM CAPACITY

4,500 lbs.

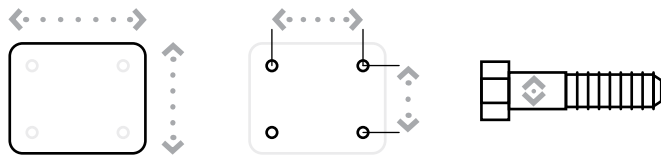

Top Plate Size	Bolt Hole Spacing	Bolt Diameter
Standard: 5" x 7.25"	3.375" x 5.25" Slotted to 4.125" x 6.125"	0.5"
Optional Top Plate 60: 4.5" x 6.25"	2.438" x 4.938" Slotted to 3.375" x 5.25"	0.5"
Optional Top Plate 75: 6" x 7"	4.625" x 5.5"	0.5"
Optional Top Plate 80: 6" x 7.5"	4.5" x 6"	0.5"

Note: OT 80 will increase OAH by 1/8"

71 SERIES TOP PLATE

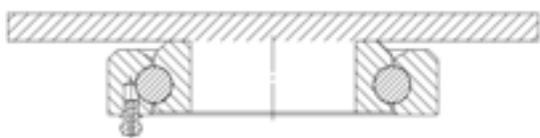

Part Numbers listed are for the swivel casters.

For rigid casters, change series to 70 and change the last digit from 1 to 2 (i.e. 70-06301-60-2)

*These casters have precision ball bearings.

Capacity listed is for manual operation. For powered operations, consult factory.

Estimated weight is for swivel caster. Deduct 20 percent of swivel caster weight for rigid casters.

All dimensions are in inches. All weights are in pounds.

CONTINUED

KINGPINLESS STYLE 71 SERIES

PRECISION BEARING

Diameter	Width	Material	Capacity	OAH	Swivel Radius	Swivel Lead	Part Number	Weight
5	2.50	Cast Iron	2,000	7.00	4.91	2.25	71-05259-10-1	24.00
5	3.00	Standard Polyurethane	1,550	7.00	4.98	2.25	71-05309-60-1	23.00
6	2.50	Cast Iron	2,500	8.00	5.40	2.25	71-06259-10-1	27.00
6	2.50	Forged Steel	4,000	8.00	5.40	2.25	71-06259-20-1	25.00
6	3.00	Cast Iron	2,500	8.00	5.46	2.25	71-06309-10-1	25.00
6	3.00	Phenolic Resin	2,000	8.00	5.46	2.25	71-06309-30-1	19.00
6	3.00	Standard Polyurethane	2,050	8.00	5.46	2.25	71-06309-60-1	21.00
6	3.00	T/R Polyurethane	1,640	8.00	5.46	2.25	71-06302-61-1*	21.00
6	3.00	H.D. Standard Polyurethane	2,450	8.00	5.46	2.25	71-06309-65-1	23.00
6	3.00	H.D. T/R Polyurethane	2,050	8.00	5.46	2.25	71-06309-66-1	23.00
6	3.00	Mold On Rubber	675	8.00	5.46	2.25	71-06309-70-1	24.00
8	3.00	Cast Iron	3,500	10.50	6.67	2.50	71-08309-10-1	34.00
8	3.00	Forged Steel	4,500	10.50	6.67	2.50	71-08309-20-1	34.00
8	3.00	Phenolic Resin	2,500	10.50	6.67	2.50	71-08309-30-1	22.00
8	3.00	Standard Polyurethane	2,500	10.50	6.67	2.50	71-08309-60-1	30.00
8	3.00	T/R Polyurethane	2,000	10.50	6.67	2.50	71-08302-61-1*	30.00
8	3.00	H.D. Standard Polyurethane	3,100	10.50	6.67	2.50	71-08309-65-1	34.00
8	3.00	H.D. T/R Polyurethane	2,500	10.50	6.67	2.50	71-08309-66-1	34.00
8	3.00	Mold On Rubber	840	10.50	6.67	2.50	71-08309-70-1	27.00
10	3.00	Cast Iron	3,500	12.50	8.14	3.00	71-10309-10-1	40.00
10	3.00	Forged Steel	4,500	12.50	8.14	3.00	71-10309-20-1	43.00
10	3.00	Phenolic Resin	2,900	12.50	8.14	3.00	71-10309-30-1	25.00
10	3.00	Standard Polyurethane	3,000	12.50	8.14	3.00	71-10309-60-1	35.00
10	3.00	T/R Polyurethane	2,400	12.50	8.14	3.00	71-10302-61-1*	35.00
10	3.00	H.D. Standard Polyurethane	3,500	12.50	8.14	3.00	71-10309-65-1	40.00
10	3.00	H.D. T/R Polyurethane	2,750	12.50	8.14	3.00	71-10309-66-1	40.00
12	3.00	Phenolic Resin	3,500	15.50	9.12	3.00	71-12309-30-1	30.00
12	3.00	Standard Polyurethane	3,500	15.50	9.12	3.00	71-12309-60-1	25.00
12	3.00	Mold On Rubber	1,125	15.50	9.12	3.00	71-12309-70-1	25.00

*These casters have precision ball bearings.

Capacity listed is for manual operation. For powered operations, consult factory.

Part Numbers listed are for the swivel casters. For rigid casters, change series to 70 and change the last digit from 1 to 2 (i.e. 70-06301-60-2)

Estimated weight is for swivel caster. Deduct 20 percent of swivel caster weight for rigid casters.

All dimensions are in inches. All weights are in pounds.



EXTRA HEAVY DUTY 77 SERIES CASTERS

KINGPINLESS STYLE 77 SERIES



FEATURES

- Swivel Section:** Sealed dual row ball bearings.
- Legs:** 3/8 inch x 2.75 inch laser cut from mild steel, CNC formed and continuously welded on the inside and outside of the yoke base.
- Kingpin:** Kingpinless style design
- Axle:** 3/4 inch diameter, zinc plated, fine threads.
- Lubrication:** Sealed ball bearing is lubricated and requires zero maintenance.
- Wheel Diameter:** 6" to 12" diameter wheels are available with sealed precision ball bearings.
- Finish:** Clear zinc plating.

APPLICATIONS

Excellent for production racks (power transported, manually handled and mobile fixtures), parts bins, conveyor system, and other applications where maintenance-free casters and ergonomics are concerns.

OPTIONS

- BRAKES**
- Poly Lock: P
 - Face Contact: F
- SWIVEL LOCKS**
- Factory Installed: L
 - Demountable: DL
- TOE GUARD:** TG

* For wheels with a diameter > 6"

MAXIMUM CAPACITY

3,500 lbs.

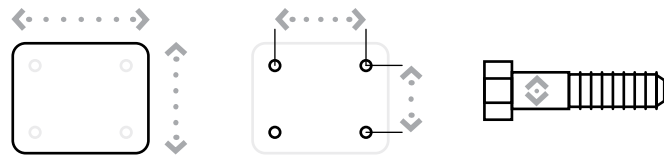

Top Plate Size	Bolt Hole Spacing	Bolt Diameter
Standard: 5" x 7.25"	3.375" x 5.25" Slotted to 4.125" x 6.125"	0.5"

77 SERIES TOP PLATE

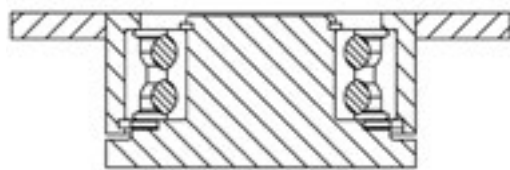

KINGPINLESS STYLE 77 SERIES

PRECISION BALL BEARING

Diameter	Width	Material	Capacity	OAH	Swivel Radius	Swivel Lead	Part Number	Weight
6	3.00	T/R Polyurethane	1,640	8.50	6.67	3.50	77-06302-61-1	20.39
6	3.00	T/R-95 Polyurethane	2,070	8.50	6.67	3.50	77-06302-91-1	20.39
6	3.00	HPPT Polyurethane	2,300	8.50	6.67	3.50	77-06302-90-1	20.39
6	3.00	T/R Polyurethane	1,640	8.50	6.67	3.50	77-06302-93-1	17.40
6	3.00	T/R-95 Polyurethane	2,070	8.50	6.67	3.50	77-06302-94-1	17.40
6	3.00	ErgoTread	1,560	8.50	6.67	3.50	77-06302-44-1	17.40
8	3.00	T/R Polyurethane	2,000	10.50	7.65	3.50	77-08302-61-1	29.96
8	3.00	T/R-95 Polyurethane	2,800	10.50	7.65	3.50	77-08302-91-1	29.96
8	3.00	HPPT Polyurethane	3,100	10.50	7.65	3.50	77-08302-90-1	29.96
8	3.00	T/R Polyurethane	2,000	10.50	7.65	3.50	77-08302-93-1	20.25
8	3.00	T/R-95 Polyurethane	2,800	10.50	7.65	3.50	77-08302-94-1	20.25
8	3.00	ErgoTread	1,900	10.50	7.65	3.50	77-08302-44-1	20.25
10	3.00	T/R Polyurethane	2,400	12.50	8.63	3.50	77-10302-61-1	36.09
10	3.00	T/R-95 Polyurethane	3,100	12.50	8.63	3.50	77-10302-91-1	36.09
10	3.00	HPPT Polyurethane	3,450	12.50	8.63	3.50	77-10302-90-1	36.09
10	3.00	T/R Polyurethane	2,400	12.50	8.63	3.50	77-10302-93-1	22.63
10	3.00	T/R-95 Polyurethane	3,100	12.50	8.63	3.50	77-10302-94-1	22.63
10	3.00	ErgoTread	2,280	12.50	8.63	3.50	77-10302-44-1	22.63
12	3.00	T/R Polyurethane	2,800	15.50	9.92	3.50	77-12302-61-1	53.97
12	3.00	T/R-95 Polyurethane	3,400	15.50	9.92	3.50	77-12302-91-1	53.97
12	3.00	HPPT Polyurethane	3,800	15.50	9.92	3.50	77-12302-90-1	53.97
12	3.00	T/R Polyurethane	2,800	15.50	9.92	3.50	77-12302-93-1	26.19
12	3.00	T/R-95 Polyurethane	3,400	15.50	9.92	3.50	77-12302-94-1	26.19
12	3.00	ErgoTread	2,660	15.50	9.92	3.50	77-12302-44-1	26.19

Capacity listed is for manual operation. For powered operations, consult factory.
Part Numbers listed are for the swivel caster. For rigid casters, change the last digit from 1 to 2 (i.e. 77-08202-60-2).
Estimated weight is for swivel caster. Deduct 20 percent of swivel caster weight for rigid casters.
All dimensions are in inches. All weights are in pounds.

EXTRA HEAVY DUTY 80 SERIES



FEATURES

Swivel Section: Drop forged from C-1045 steel with 5" diameter, precision machined load raceway. A 1-1/4" tapered thrust bearing completes the precision fit.

Legs: 3/8" x 4" formed and continuously welded both inside and outside.

Kingpin: 1-1/4" integrally forged kingpin with slotted adjusting nut.

Axle: 1", Grade 5 axle.

Lubrication: Pre-lubricated before shipping.

Wheels: 6" to 12" diameter wheels.

Finish: Gold Powder Coat

APPLICATIONS

Die carts, automotive plants, steel mills, production line delivery trailers, fiberglass lay up molds, stamping racks, aircraft maintenance, aircraft crew stairs, trash gondolas and other aircraft ground support equipment.

BENEFITS

The 80 Series has a ball load swivel that delivers high capacity at a good value. The raceways are heat treated to eliminate brinelling of the surface when the casters are subjected to shock loads. The exceptional strength of the 80 Series makes it an ideal choice for rugged applications. These casters are built around automotive industry standards. Please consult factory.

OPTIONS

BRAKES

Poly Lock: P*
Wrap Around: W*
Face Contact: F

SWIVEL LOCKS

Factory Installed: L
Heavy Duty Demountable: DHDL
Heavy Duty: HDL
Demountable: DL
Foot Actuated: KL

SEALED SWIVEL SECTION SSW

SEALED WHEELS SW

TOE GUARD TG

* For wheels with a diameter > 6"
Contact the factory for special overall heights and finishes.
DUAL WHEEL DESIGN AVAILABLE

EXTRA HEAVY DUTY 80 SERIES

STRAIGHT ROLLER BEARING

Diameter	Width	Material	Capacity	OAH	Swivel Radius	Swivel Lead	Part Number	Weight
6	2.50	Forged Steel	4,000	8.50	5.64	2.50	80-06251-20-1	38.00
6	3.00	H.D. Standard Polyurethane	2,500	8.50	5.70	2.50	80-06301-65-1	40.00
6	3.00	Standard Polyurethane	2,050	8.50	5.70	2.50	80-06301-60-1	37.00
6	3.00	Laminated Phenolic	2,500	8.50	5.70	2.50	80-06301-35-1	30.00
6	3.00	Forged Steel	5,000	8.50	5.70	2.50	80-06301-20-1	45.00
6	3.00	Cast Iron	2,500	8.50	5.70	2.50	80-06301-10-1	36.00
6	4.00	H.D. Standard Polyurethane	3,000	8.50	5.85	2.50	80-06401-65-1	36.00
8	3.00	Mold On Rubber	825	10.50	6.67	2.50	80-08301-70-1	37.00
8	3.00	H.D. T/R Polyurethane	2,500	10.50	6.67	2.50	80-08301-66-1	45.00
8	3.00	Standard Polyurethane	2,500	10.50	6.67	2.50	80-08301-60-1	40.00
8	3.00	H.D. Standard Polyurethane	3,100	10.50	6.67	2.50	80-08301-65-1	45.00
8	3.00	Laminated Phenolic	3,000	10.50	6.67	2.50	80-08301-35-1	32.00
8	3.00	Forged Steel	5,000	10.50	6.67	2.50	80-08301-20-1	44.00
8	3.00	Cast Iron	4,500	10.50	6.67	2.50	80-08301-11-1	40.00
8	4.00	Standard Polyurethane	3,800	10.50	6.80	2.50	80-08401-60-1	48.00
8	4.00	Forged Steel	5,000	10.50	6.80	2.50	80-08401-20-1	48.00
10	3.00	Mold On Rubber	1,000	12.50	7.65	2.50	80-10301-70-1	50.00
10	3.00	H.D. T/R Polyurethane	2,800	12.50	7.65	2.50	80-10301-66-1	55.00
10	3.00	Standard Polyurethane	3,000	12.50	7.65	2.50	80-10301-60-1	49.00
10	3.00	H.D. Standard Polyurethane	3,700	12.50	7.65	2.50	80-10301-65-1	55.00
10	3.00	Laminated Phenolic	3,250	12.50	7.65	2.50	80-10301-35-1	36.00
10	3.00	H.D. Forged Steel	5,000	12.50	7.65	2.50	80-10301-21-1	54.00
10	3.00	Cast Iron	4,000	12.50	7.65	2.50	80-10301-11-1	50.00
10	4.00	Mold On Rubber	1,500	12.50	7.76	2.50	80-10401-70-1	51.00
10	4.00	Standard Polyurethane	4,200	12.50	7.76	2.50	80-10401-60-1	55.00
10	4.00	H.D. Standard Polyurethane	5,000	12.50	7.76	2.50	80-10401-65-1	60.00
10	4.00	Forged Steel	5,000	12.50	7.76	2.50	80-10401-20-1	74.00
12	3.00	Mold On Rubber	1,125	15.50	8.63	2.50	80-12301-70-1	55.00
12	3.00	H.D. T/R Polyurethane	2,900	15.50	8.63	2.50	80-12301-66-1	57.00
12	3.00	H.D. Standard Polyurethane	3,850	15.50	8.63	2.50	80-12301-65-1	53.00
12	3.00	Standard Polyurethane	3,500	15.50	8.63	2.50	80-12301-60-1	53.00
12	4.00	Mold On Rubber	1,600	15.50	8.73	2.50	80-12401-70-1	58.00
12	4.00	H.D. T/R Polyurethane	3,800	15.50	8.73	2.50	80-12401-66-1	70.00
12	4.00	H.D. Standard Polyurethane	5,000	15.50	8.73	2.50	80-12401-65-1	70.00
12	4.00	H.D. Hard Polyurethane (70D)	5,000	15.50	8.73	2.50	80-12401-67-1	53.00

Capacity listed is for manual operation. For powered operations, consult factory.
Part Numbers listed are for the swivel casters. For rigid casters, change the last digit from 1 to 2 (i.e. 80-10309-70-2)
Estimated weight is for swivel caster. Deduct 20 percent of swivel caster weight for rigid casters.
All dimensions are in inches. All weights are in pounds.

CONTINUED

MAXIMUM CAPACITY
5,000 lbs.

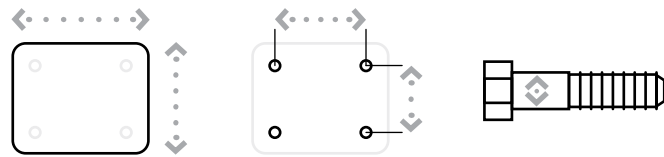

Top Plate Size	Bolt Hole Spacing	Bolt Diameter
Standard: 6" x 7.5"	4.5" x 6"	0.5"
OT-CJ: Optional Top Plate Columbus Jack 6" x 7.5"	4.625" x 5.5"	0.5"

80 SERIES TOP PLATE

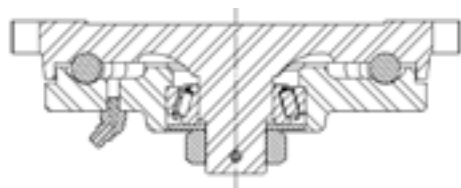

EXTRA HEAVY DUTY 80 SERIES

PRECISION TAPERED BEARING

Diameter	Width	Material	Capacity	OAH	Swivel Radius	Swivel Lead	Part Number	Weight
6	2.50	Forged Steel	5,000	8.50	5.64	2.50	80-06259-20-1	38.00
6	3.00	H.D. T/R Polyurethane	1,640	8.50	5.70	2.50	80-06309-66-1	37.00
6	3.00	H.D. Standard Polyurethane	2,500	8.50	5.70	2.50	80-06309-65-1	40.00
6	3.00	Standard Polyurethane	2,050	8.50	5.70	2.50	80-06309-60-1	37.00
6	3.00	Laminated Phenolic	2,500	8.50	5.70	2.50	80-06309-35-1	30.00
6	3.00	Forged Steel	5,000	8.50	5.70	2.50	80-06309-20-1	45.00
6	3.00	Cast Iron	2,500	8.50	5.70	2.50	80-06309-10-1	36.00
6	4.00	H.D. Standard Polyurethane	3,000	8.50	5.85	2.50	80-06409-65-1	36.00
8	3.00	Mold On Rubber	825	10.50	6.67	2.50	80-08309-70-1	37.00
8	3.00	H.D. T/R Polyurethane	2,500	10.50	6.67	2.50	80-08309-66-1	45.00
8	3.00	Standard Polyurethane	2,500	10.50	6.67	2.50	80-08309-60-1	40.00
8	3.00	H.D. Standard Polyurethane	3,100	10.50	6.67	2.50	80-08309-65-1	45.00
8	3.00	Laminated Phenolic	3,000	10.50	6.67	2.50	80-08309-35-1	32.00
8	3.00	Forged Steel	5,000	10.50	6.67	2.50	80-08309-20-1	44.00
8	3.00	Cast Iron	4,500	10.50	6.67	2.50	80-08309-11-1	40.00
8	4.00	Standard Polyurethane	3,800	10.50	6.80	2.50	80-08409-60-1	48.00
8	4.00	Forged Steel	5,000	10.50	6.80	2.50	80-08409-20-1	48.00
10	3.00	Mold On Rubber	1,000	12.50	7.65	2.50	80-10309-70-1	50.00
10	3.00	H.D. T/R Polyurethane	2,800	12.50	7.65	2.50	80-10309-66-1	55.00
10	3.00	Standard Polyurethane	3,000	12.50	7.65	2.50	80-10309-60-1	49.00
10	3.00	H.D. Standard Polyurethane	3,700	12.50	7.65	2.50	80-10309-65-1	55.00
10	3.00	Laminated Phenolic	3,250	12.50	7.65	2.50	80-10309-35-1	36.00
10	3.00	H.D. Forged Steel	5,000	12.50	7.65	2.50	80-10309-21-1	54.00
10	3.00	Cast Iron	4,000	12.50	7.65	2.50	80-10309-11-1	50.00
10	4.00	Mold On Rubber	1,500	12.50	7.76	2.50	80-10409-70-1	51.00
10	4.00	Standard Polyurethane	4,200	12.50	7.76	2.50	80-10409-60-1	55.00
10	4.00	H.D. T/R Polyurethane	4,000	12.50	7.76	2.50	80-10409-66-1	60.00
10	4.00	H.D. Standard Polyurethane	5,000	12.50	7.76	2.50	80-10409-65-1	60.00
10	4.00	Forged Steel	5,000	12.50	7.76	2.50	80-10409-20-1	74.00
12	3.00	Mold On Rubber	1,125	15.50	8.63	2.50	80-12309-70-1	55.00
12	3.00	H.D. T/R Polyurethane	2,900	15.50	8.63	2.50	80-12309-66-1	57.00
12	3.00	H.D. Standard Polyurethane	3,850	15.50	8.63	2.50	80-12309-65-1	53.00
12	3.00	Standard Polyurethane	3,500	15.50	8.63	2.50	80-12309-60-1	53.00
12	4.00	Mold On Rubber	1,600	15.50	8.73	2.50	80-12409-70-1	58.00
12	4.00	H.D. T/R Polyurethane	3,800	15.50	8.73	2.50	80-12409-66-1	70.00
12	4.00	H.D. Standard Polyurethane	5,000	15.50	8.73	2.50	80-12409-65-1	70.00
12	4.00	H.D. Hard Polyurethane (70D)	5,000	15.50	8.73	2.50	80-12409-67-1	53.00

Capacity listed is for manual operation. For powered operations, consult factory.

Part Numbers listed are for the swivel casters. For rigid casters, change the last digit from 1 to 2 (i.e. 80-10309-70-2)

Estimated weight is for swivel caster. Deduct 20 percent of swivel caster weight for rigid casters.

All dimensions are in inches. All weights are in pounds.



KINGPINLESS STYLE 81 SERIES CASTERS

KINGPINLESS STYLE 81 SERIES



FEATURES

Swivel Section: Constructed from drop forged C-1045 steel. The swivel section features a large precision machined 4" single ball bearing load/thrust raceway. The unique raceway places the 3/4" diameter load/thrust ball bearings in shear, locking the swivel section together.

Legs: 3/8" x 4" formed and continuously welded both inside and outside.

Kingpin: Kingpinless style design.

Axle: 1", Grade 5 axle.

Lubrication: Pre-lubricated before shipping.

Wheels: 6" to 12" diameter wheels.

Finish: Gold Powder Coat.

Standard: Shielded swivel.

APPLICATIONS

Suitable for power drawn applications, fiberglass mold dollies, aircraft wing and spar tooling, machinery, engine and paint line dollies, body dolly carts, material carts, chassis rack carts, towed trash gondolas, aircraft maintenance stands, production line delivery trailers and automated guided vehicles.

BENEFITS

The 81 Series kingpinless style casters feature a unique single ball race design. This design provides a high strength swivel section that will swivel easily under extremely heavy loads.

OPTIONS

BRAKES

Poly Lock: P*
 Wrap Around: W*
 Face Contact: F

SWIVEL LOCKS

Factory Installed: L
 Heavy Duty: HDL
 Heavy Duty Demountable: DHDL
 Demountable: DL
 Foot Actuated: KL

SEALED SWIVEL SECTION SSW

SEALED WHEELS SW

TOE GUARD TG

* For wheels with a diameter > 6"
 Contact the factory for special overall heights and finishes.
 DUAL WHEEL DESIGN AVAILABLE

KINGPINLESS STYLE 81 SERIES

STRAIGHT ROLLER BEARING

Diameter	Width	Material	Capacity	OAH	Swivel Radius	Swivel Lead	Part Number	Weight
6	2.50	Forged Steel	4,000	8.50	5.64	2.50	81-06251-20-1	38.00
6	3.00	Standard Polyurethane	2,050	8.50	5.70	2.50	81-06301-60-1	37.00
6	3.00	H.D. Standard Polyurethane	2,500	8.50	5.70	2.50	81-06301-65-1	40.00
6	3.00	Laminated Phenolic	2,500	8.50	5.70	2.50	81-06301-35-1	30.00
6	3.00	Forged Steel	6,000	8.50	5.70	2.50	81-06301-20-1	45.00
6	3.00	Cast Iron	2,500	8.50	5.70	2.50	81-06301-10-1	36.00
6	4.00	H.D. Standard Polyurethane	3,000	8.50	5.85	2.50	81-06401-65-1	40.00
8	3.00	Mold On Rubber	825	10.50	6.67	2.50	81-08301-70-1	37.00
8	3.00	H.D. T/R Polyurethane	2,500	10.50	6.67	2.50	81-08301-66-1	45.00
8	3.00	Standard Polyurethane	2,500	10.50	6.67	2.50	81-08301-60-1	40.00
8	3.00	H.D. Standard Polyurethane	3,100	10.50	6.67	2.50	81-08301-65-1	45.00
8	3.00	Laminated Phenolic	3,000	10.50	6.67	2.50	81-08301-35-1	32.00
8	3.00	Forged Steel	4,500	10.50	6.67	2.50	81-08301-20-1	44.00
8	3.00	Cast Iron	3,500	10.50	6.67	2.50	81-08301-11-1	40.00
8	4.00	Standard Polyurethane	3,800	10.50	6.80	2.50	81-08401-60-1	48.00
8	4.00	Forged Steel	8,400	10.50	6.80	2.50	81-08401-20-1	48.00
10	3.00	Mold On Rubber	1,000	12.50	7.65	2.50	81-10301-70-1	50.00
10	3.00	H.D. T/R Polyurethane	2,800	12.50	7.65	2.50	81-10301-66-1	55.00
10	3.00	Standard Polyurethane	3,000	12.50	7.65	2.50	81-10301-60-1	49.00
10	3.00	H.D. Standard Polyurethane	3,700	12.50	7.65	2.50	81-10301-65-1	55.00
10	3.00	Laminated Phenolic	3,250	12.50	7.65	2.50	81-10301-35-1	36.00
10	3.00	H.D. Forged Steel	5,000	12.50	7.65	2.50	81-10301-21-1	54.00
10	3.00	Cast Iron	4,000	12.50	7.65	2.50	81-10301-11-1	50.00
10	4.00	Mold On Rubber	1,500	12.50	7.76	2.50	81-10401-70-1	51.00
10	4.00	Standard Polyurethane	4,200	12.50	7.76	2.50	81-10401-60-1	55.00
10	4.00	H.D. Standard Polyurethane	5,000	12.50	7.76	2.50	81-10401-65-1	60.00
10	4.00	Forged Steel	8,400	12.50	7.76	2.50	81-10401-20-1	74.00
12	3.00	Mold On Rubber	1,125	15.50	8.63	2.50	81-12301-70-1	55.00
12	3.00	Ductile Iron	6,500	15.50	8.63	2.50	81-12301-12-1	70.00
12	3.00	H.D. T/R Polyurethane	2,900	15.50	8.63	2.50	81-12301-66-1	57.00
12	3.00	H.D. Standard Polyurethane	3,850	15.50	8.63	2.50	81-12301-65-1	53.00
12	3.00	Standard Polyurethane	3,500	15.50	8.63	2.50	81-12301-60-1	53.00
12	4.00	Mold On Rubber	1,600	15.50	8.73	2.50	81-12401-70-1	58.00
12	4.00	Ductile Iron	7,500	15.50	8.73	2.50	81-12401-12-1	70.00
12	4.00	H.D. T/R Polyurethane	3,800	15.50	8.73	2.50	81-12401-66-1	70.00
12	4.00	H.D. Standard Polyurethane	5,500	15.50	8.73	2.50	81-12401-65-1	70.00
12	4.00	H.D. Hard Polyurethane (70D)	6,600	15.50	8.73	2.50	81-12401-67-1	70.00

Capacity listed is for manual operation. For powered operations, consult factory.
 Part Numbers listed are for the swivel casters.

For rigid casters, change series to 80 and change the last digit from 1 to 2 (i.e. 80-12409-70-2)
 Estimated weight is for swivel caster. Deduct 20 percent of swivel caster weight for rigid casters.
 All dimensions are in inches. All weights are in pounds.

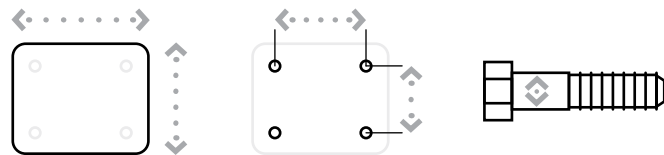

Top Plate Size	Bolt Hole Spacing	Bolt Diameter
Standard: 6.25" x 7.63"	4.5" x 6"	0.5"

81 SERIES TOP PLATE

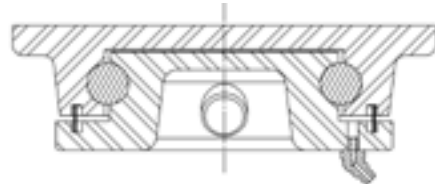

KINGPINLESS STYLE 81 SERIES

PRECISION TAPERED BEARING

Diameter	Width	Material	Capacity	OAH	Swivel Radius	Swivel Lead	Part Number	Weight
6	2.50	Forged Steel	5,000	8.50	5.64	2.50	81-06259-20-1	38.00
6	3.00	H.D. T/R Polyurethane	1,640	8.50	5.70	2.50	81-06309-66-1	37.00
6	3.00	Standard Polyurethane	2,050	8.50	5.70	2.50	81-06309-60-1	37.00
6	3.00	H.D. Standard Polyurethane	2,500	8.50	5.70	2.50	81-06309-65-1	40.00
6	3.00	Laminated Phenolic	2,500	8.50	5.70	2.50	81-06309-35-1	30.00
6	3.00	Forged Steel	10,000	8.50	5.70	2.50	81-06309-20-1	45.00
6	3.00	Cast Iron	9,000	8.50	5.70	2.50	81-06309-10-1	36.00
6	4.00	H.D. Standard Polyurethane	3,000	8.50	5.85	2.50	81-06409-65-1	40.00
8	3.00	Mold On Rubber	825	10.50	6.67	2.50	81-08309-70-1	37.00
8	3.00	H.D. T/R Polyurethane	2,500	10.50	6.67	2.50	81-08309-66-1	45.00
8	3.00	Standard Polyurethane	2,500	10.50	6.67	2.50	81-08309-60-1	40.00
8	3.00	H.D. Standard Polyurethane	3,100	10.50	6.67	2.50	81-08309-65-1	45.00
8	3.00	Laminated Phenolic	3,000	10.50	6.67	2.50	81-08309-35-1	32.00
8	3.00	Forged Steel	5,500	10.50	6.67	2.50	81-08309-20-1	44.00
8	3.00	Cast Iron	3,500	10.50	6.67	2.50	81-08309-11-1	40.00
8	4.00	Standard Polyurethane	3,800	10.50	6.80	2.50	81-08409-60-1	48.00
8	4.00	Forged Steel	10,000	10.50	6.80	2.50	81-08409-20-1	48.00
10	3.00	Mold On Rubber	1,000	12.50	7.65	2.50	81-10309-70-1	50.00
10	3.00	H.D. T/R Polyurethane	2,800	12.50	7.65	2.50	81-10309-66-1	55.00
10	3.00	Standard Polyurethane	3,000	12.50	7.65	2.50	81-10309-60-1	49.00
10	3.00	H.D. Standard Polyurethane	3,700	12.50	7.65	2.50	81-10309-65-1	55.00
10	3.00	Laminated Phenolic	3,250	12.50	7.65	2.50	81-10309-35-1	36.00
10	3.00	H.D. Forged Steel	6,500	12.50	7.65	2.50	81-10309-21-1	54.00
10	3.00	Cast Iron	4,000	12.50	7.65	2.50	81-10309-11-1	50.00
10	4.00	Mold On Rubber	1,500	12.50	7.76	2.50	81-10409-70-1	51.00
10	4.00	Standard Polyurethane	4,200	12.50	7.76	2.50	81-10409-60-1	55.00
10	4.00	H.D. T/R Polyurethane	4,000	12.50	7.76	2.50	81-10409-66-1	60.00
10	4.00	H.D. Standard Polyurethane	5,000	12.50	7.76	2.50	81-10409-65-1	60.00
10	4.00	Forged Steel	10,000	12.50	7.76	2.50	81-10409-20-1	74.00
12	3.00	Mold On Rubber	1,125	15.50	8.63	2.50	81-12309-70-1	55.00
12	3.00	Ductile Iron	6,500	15.50	8.63	2.50	81-12309-12-1	70.00
12	3.00	H.D. T/R Polyurethane	2,900	15.50	8.63	2.50	81-12309-66-1	57.00
12	3.00	H.D. Standard Polyurethane	3,850	15.50	8.63	2.50	81-12309-65-1	53.00
12	3.00	Standard Polyurethane	3,500	15.50	8.63	2.50	81-12309-60-1	53.00
12	4.00	Mold On Rubber	1,600	15.50	8.73	2.50	81-12409-70-1	58.00
12	4.00	Ductile Iron	7,500	15.50	8.73	2.50	81-12409-12-1	70.00
12	4.00	H.D. T/R Polyurethane	3,800	15.50	8.73	2.50	81-12409-66-1	70.00
12	4.00	H.D. Standard Polyurethane	5,500	15.50	8.73	2.50	81-12409-65-1	70.00
12	4.00	H.D. Hard Polyurethane (70D)	6,600	15.50	8.73	2.50	81-12409-67-1	70.00

Capacity listed is for manual operation. For powered operations, consult factory.

Part Numbers listed are for the swivel casters. For rigid casters, change series to 80 and change the last digit from 1 to 2 (i.e. 80-12409-70-2)

Estimated weight is for swivel caster. Deduct 20 percent of swivel caster weight for rigid casters.

All dimensions are in inches. All weights are in pounds.



EXTRA HEAVY DUTY 85 SERIES CASTERS

EXTRA HEAVY DUTY 85 SERIES



FEATURES

Swivel Section: Constructed from hot forged C-1045 steel, the swivel section features a large precision machined raceway, with a precision tapered load and tapered thrust bearing.

Legs: 3/8" x 4" legs are formed and continuously welded both inside and outside.

Kingpin: 1-1/4" integrally forged kingpin with slotted adjusting nut.

Axle: 1", Grade 5 axle.

Lubrication: Pre-lubricated before shipping.

Wheels: 6" to 12" diameter wheels.

Finish: Gold Powder Coat.

APPLICATIONS

Applications may include high capacity die tables, die carts, towed trailers, aerospace industry, steel mills, gantries, automated guided vehicles and aircraft maintenance applications.

BENEFITS

The tapered load bearing and thrust bearing enhance the precision nature of this caster creating a swivel section with the highest load carrying capacity for its class. The 85 Series delivers an exceptionally tight tolerance fit. Additionally, the integrally forged kingpin and slotted adjusting nut add strength and longevity to the life of the swivel section.

OPTIONS

BRAKES

Poly Lock: P*
Wrap Around: W*
Face Contact: F

SWIVEL LOCKS

Factory Installed: L
Heavy Duty Demountable: DHDL
Heavy Duty: HDL
Foot Actuated: KL

SEALED SWIVEL SECTION SSW

SEALED WHEELS SW

TOE GUARD TG

* For wheels with a diameter > 6"
Contact the factory for special overall heights and finishes.
DUAL WHEEL DESIGN AVAILABLE

EXTRA HEAVY DUTY 85 SERIES

STRAIGHT ROLLER BEARING

Diameter	Width	Material	Capacity	OAH	Swivel Radius	Swivel Lead	Part Number	Weight
6	2.50	Forged Steel	4,000	8.50	5.64	2.50	85-06251-20-1	38.00
6	3.00	H.D. Standard Polyurethane	2,500	8.50	5.70	2.50	85-06301-65-1	40.00
6	3.00	Standard Polyurethane	2,050	8.50	5.70	2.50	85-06301-60-1	37.00
6	3.00	Laminated Phenolic	2,500	8.50	5.70	2.50	85-06301-35-1	30.00
6	3.00	Forged Steel	6,000	8.50	5.70	2.50	85-06301-20-1	45.00
6	3.00	Cast Iron	2,500	8.50	5.70	2.50	85-06301-10-1	36.00
6	4.00	H.D. Standard Polyurethane	3,000	8.50	5.85	2.50	85-06401-65-1	36.00
8	3.00	Mold On Rubber	825	10.50	6.67	2.50	85-08301-70-1	37.00
8	3.00	H.D. T/R Polyurethane	2,500	10.50	6.67	2.50	85-08301-66-1	45.00
8	3.00	Standard Polyurethane	2,500	10.50	6.67	2.50	85-08301-60-1	40.00
8	3.00	H.D. Standard Polyurethane	3,100	10.50	6.67	2.50	85-08301-65-1	45.00
8	3.00	Laminated Phenolic	3,000	10.50	6.67	2.50	85-08301-35-1	32.00
8	3.00	Forged Steel	4,500	10.50	6.67	2.50	85-08301-20-1	44.00
8	3.00	Cast Iron	3,500	10.50	6.67	2.50	85-08301-10-1	40.00
8	4.00	Standard Polyurethane	3,800	10.50	6.80	2.50	85-08401-60-1	48.00
8	4.00	Forged Steel	8,400	10.50	6.80	2.50	85-08401-20-1	48.00
10	3.00	Mold On Rubber	1,000	12.50	7.65	2.50	85-10301-70-1	50.00
10	3.00	H.D. T/R Polyurethane	2,800	12.50	7.65	2.50	85-10301-66-1	55.00
10	3.00	Standard Polyurethane	3,000	12.50	7.65	2.50	85-10301-60-1	49.00
10	3.00	H.D. Standard Polyurethane	3,700	12.50	7.65	2.50	85-10301-65-1	55.00
10	3.00	Laminated Phenolic	3,250	12.50	7.65	2.50	85-10301-35-1	36.00
10	3.00	H.D. Forged Steel	5,000	12.50	7.65	2.50	85-10301-21-1	54.00
10	3.00	Cast Iron	4,000	12.50	7.65	2.50	85-10301-11-1	50.00
10	4.00	Mold On Rubber	1,500	12.50	7.76	2.50	85-10401-70-1	51.00
10	4.00	Standard Polyurethane	4,200	12.50	7.76	2.50	85-10401-60-1	55.00
10	4.00	H.D. Standard Polyurethane	5,000	12.50	7.76	2.50	85-10401-65-1	60.00
10	4.00	Forged Steel	8,400	12.50	7.76	2.50	85-10401-20-1	74.00
12	3.00	Mold On Rubber	1,125	15.50	8.63	2.50	85-12301-70-1	55.00
12	3.00	H.D. T/R Polyurethane	2,900	15.50	8.63	2.50	85-12301-66-1	57.00
12	3.00	H.D. Standard Polyurethane	3,850	15.50	8.63	2.50	85-12301-65-1	53.00
12	3.00	Standard Polyurethane	3,500	15.50	8.63	2.50	85-12301-60-1	55.00
12	4.00	Mold On Rubber	1,600	15.50	8.73	2.50	85-12401-70-1	58.00
12	4.00	H.D. T/R Polyurethane	3,800	15.50	8.73	2.50	85-12401-66-1	70.00
12	4.00	H.D. Standard Polyurethane	5,000	15.50	8.73	2.50	85-12401-65-1	70.00
12	4.00	Ductile Iron	7,500	15.50	8.73	2.50	85-12401-12-1	90.00

Capacity listed is for manual operation. For powered operations, consult factory.
Part Numbers listed are for the swivel casters.
For rigid casters, change series to 80 and change the last digit from 1 to 2 (i.e. 80-12409-70-2)
Estimated weight is for swivel caster. Deduct 20 percent of swivel caster weight for rigid casters.
All dimensions are in inches. All weights are in pounds.

MAXIMUM CAPACITY
10,000 lbs.

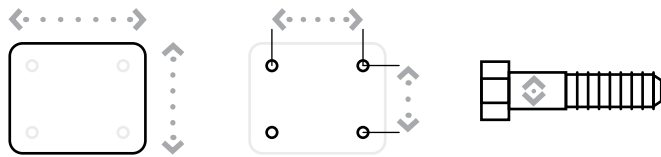

Top Plate Size	Bolt Hole Spacing	Bolt Diameter
Standard: 6" x 7.5"	4.5" x 6"	0.5"



EXTRA HEAVY DUTY 85 SERIES

PRECISION TAPERED BEARING

Diameter	Width	Material	Capacity	OAH	Swivel Radius	Swivel Lead	Part Number	Weight
6	2.50	Forged Steel	5,000	8.50	5.64	2.50	85-06259-20-1	38.00
6	3.00	H.D. T/R Polyurethane	1,640	8.50	5.70	2.50	85-06309-66-1	37.00
6	3.00	H.D. Standard Polyurethane	2,500	8.50	5.70	2.50	85-06309-65-1	40.00
6	3.00	Standard Polyurethane	2,050	8.50	5.70	2.50	85-06309-60-1	37.00
6	3.00	Laminated Phenolic	2,500	8.50	5.70	2.50	85-06309-35-1	30.00
6	3.00	Forged Steel	10,000	8.50	5.70	2.50	85-06309-20-1	45.00
6	3.00	Cast Iron	2,500	8.50	5.70	2.50	85-06309-10-1	36.00
6	4.00	H.D. Standard Polyurethane	3,000	8.50	5.85	2.50	85-06409-65-1	36.00
8	3.00	Mold On Rubber	825	10.50	6.67	2.50	85-08309-70-1	37.00
8	3.00	H.D. T/R Polyurethane	2,500	10.50	6.67	2.50	85-08309-66-1	45.00
8	3.00	Standard Polyurethane	2,500	10.50	6.67	2.50	85-08309-60-1	40.00
8	3.00	H.D. Standard Polyurethane	3,100	10.50	6.67	2.50	85-08309-65-1	45.00
8	3.00	Laminated Phenolic	3,000	10.50	6.67	2.50	85-08309-35-1	32.00
8	3.00	Forged Steel	5,500	10.50	6.67	2.50	85-08309-20-1	44.00
8	3.00	Cast Iron	3,500	10.50	6.67	2.50	85-08309-10-1	40.00
8	4.00	Standard Polyurethane	3,800	10.50	6.80	2.50	85-08409-60-1	48.00
8	4.00	Forged Steel	10,000	10.50	6.80	2.50	85-08409-20-1	48.00
10	3.00	Mold On Rubber	1,000	12.50	7.65	2.50	85-10309-70-1	50.00
10	3.00	H.D. T/R Polyurethane	2,800	12.50	7.65	2.50	85-10309-66-1	55.00
10	3.00	Standard Polyurethane	3,000	12.50	7.65	2.50	85-10309-60-1	49.00
10	3.00	H.D. Standard Polyurethane	3,700	12.50	7.65	2.50	85-10309-65-1	55.00
10	3.00	Laminated Phenolic	3,250	12.50	7.65	2.50	85-10309-35-1	36.00
10	3.00	H.D. Forged Steel	6,500	12.50	7.65	2.50	85-10309-21-1	54.00
10	3.00	Cast Iron	4,000	12.50	7.65	2.50	85-10309-11-1	50.00
10	4.00	Mold On Rubber	1,500	12.50	7.76	2.50	85-10409-70-1	51.00
10	4.00	Standard Polyurethane	4,200	12.50	7.76	2.50	85-10409-60-1	55.00
10	4.00	H.D. Standard Polyurethane	5,000	12.50	7.76	2.50	85-10409-65-1	60.00
10	4.00	Forged Steel	10,000	12.50	7.76	2.50	85-10409-20-1	74.00
12	3.00	Mold On Rubber	1,125	15.50	8.63	2.50	85-12309-70-1	55.00
12	3.00	H.D. T/R Polyurethane	2,900	15.50	8.63	2.50	85-12309-66-1	57.00
12	3.00	H.D. Standard Polyurethane	3,850	15.50	8.63	2.50	85-12309-65-1	53.00
12	3.00	Standard Polyurethane	3,500	15.50	8.63	2.50	85-12309-60-1	55.00
12	4.00	Mold On Rubber	1,600	15.50	8.73	2.50	85-12409-70-1	58.00
12	4.00	H.D. T/R Polyurethane	3,800	15.50	8.73	2.50	85-12409-66-1	70.00
12	4.00	H.D. Standard Polyurethane	5,000	15.50	8.73	2.50	85-12409-65-1	70.00
12	4.00	Ductile Iron	7,500	15.50	8.73	2.50	85-12409-12-1	90.00

Capacity listed is for manual operation. For powered operations, consult factory.

Part Numbers listed are for the swivel casters. For rigid casters, change series to 80 and change the last digit from 1 to 2 (i.e. 80-12409-70-2)

Estimated weight is for swivel caster. Deduct 20 percent of swivel caster weight for rigid casters.

All dimensions are in inches. All weights are in pounds.



EXTRA HEAVY DUTY 87 SERIES CASTERS

EXTRA HEAVY DUTY 87 SERIES



FEATURES

- Swivel Section:** Sealed precision ball bearing with hardened raceways and neoprene seals.
- Legs:** 3/8" x 3" steel, formed and continuously welded on the inside and outside to the yoke base.
- Kingpin:** 1" Alloy Steel Kingpin.
- Axle:** 1" Diameter Axle.
- Lubrication:** Sealed ball bearing is lubricated and requires zero maintenance.
- Wheels:** 6" to 12" diameter wheels.
- Finish:** Gold Powder Coat.

APPLICATIONS

Suitable for power drawn applications, Automated Guided Vehicles (AGV's), aircraft wing and spar tooling, material carts, chassis rack carts, and aircraft maintenance stands.

BENEFITS

The 87 Series is maintenance free with its sealed precision ball bearing in the swivel section and in the wheels. The smooth rotation and extended lead help lower ergonomic forces.

OPTIONS

BRAKES

- Poly Lock: P*
- Face Contact: F

SWIVEL LOCKS

- Factory Installed: L
- Demountable: DL
- Foot Actuated: KL

- TOE GUARD** TG

* For wheels with a diameter > 6"
Contact the factory for special overall heights and finishes.
DUAL WHEEL DESIGN AVAILABLE

EXTRA HEAVY DUTY 87 SERIES

PRECISION BALL BEARING

Diameter	Width	Material	Capacity	OAH	Swivel Radius	Swivel Lead	Part Number	Weight
6	3.00	T/R Polyurethane	1,640	9.50	6.18	3.00	87-06302-61-1	36.59
6	3.00	T/R-95 Polyurethane	2,070	9.50	6.18	3.00	87-06302-91-1	36.59
6	3.00	HPPT Polyurethane	2,300	9.50	6.18	3.00	87-06302-90-1	36.59
6	3.00	T/R Polyurethane	1,640	9.50	6.18	3.00	87-06302-93-1	29.18
6	3.00	T/R-95 Polyurethane	2,070	9.50	6.18	3.00	87-06302-94-1	29.18
8	3.00	T/R Polyurethane	2,000	11.50	7.16	3.00	87-08302-61-1	41.83
8	3.00	T/R-95 Polyurethane	2,800	11.50	7.16	3.00	87-08302-91-1	41.83
8	3.00	HPPT Polyurethane	3,100	11.50	7.16	3.00	87-08302-90-1	41.83
8	3.00	T/R Polyurethane	2,000	11.50	7.16	3.00	87-08302-93-1	31.97
8	3.00	T/R-95 Polyurethane	2,800	11.50	7.16	3.00	87-08302-94-1	31.97
10	3.00	T/R Polyurethane	2,400	13.50	8.14	3.00	87-10302-61-1	47.07
10	3.00	T/R-95 Polyurethane	3,100	13.50	8.14	3.00	87-10302-91-1	47.07
10	3.00	HPPT Polyurethane	3,450	13.50	8.14	3.00	87-10302-90-1	47.07
10	3.00	T/R Polyurethane	2,400	13.50	8.14	3.00	87-10302-93-1	33.78
10	3.00	T/R-95 Polyurethane	3,100	13.50	8.14	3.00	87-10302-94-1	33.78
12	3.00	T/R Polyurethane	2,800	15.75	9.12	3.00	87-12302-61-1	54.09
12	3.00	T/R-95 Polyurethane	3,400	15.75	9.12	3.00	87-12302-91-1	54.09
12	3.00	HPPT Polyurethane	3,800	15.75	9.12	3.00	87-12302-90-1	54.09
12	3.00	T/R Polyurethane	2,800	15.75	9.12	3.00	87-12302-93-1	37.34
12	3.00	T/R-95 Polyurethane	3,400	15.75	9.12	3.00	87-12302-94-1	37.34

MAXIMUM CAPACITY

5,000 lbs.

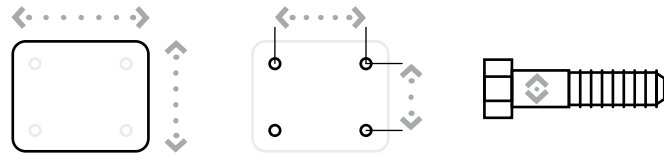

Top Plate Size	Bolt Hole Spacing	Bolt Diameter
Standard: 6" x 7.5"	4.5" x 6"	0.5"

87 SERIES TOP PLATE

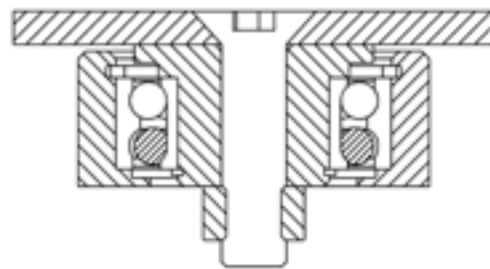

Capacity listed is for manual operation. For powered operations, consult factory.
Part Numbers listed are for the swivel casters. For rigid casters, change series to 80 and change the last digit from 1 to 2 (i.e. 87-12409-70-2)
Estimated weight is for swivel caster. Deduct 20 percent of swivel caster weight for rigid casters.
All dimensions are in inches. All weights are in pounds.

EXTRA HEAVY DUTY 90 SERIES



MAXIMUM CAPACITY

8,000 lbs.

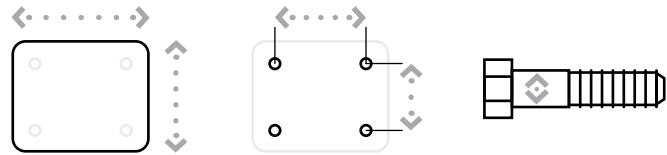

Top Plate Size	Bolt Hole Spacing	Bolt Diameter
Standard: 8.5" x 8.5"	7" x 7"	.625"

90 SERIES TOP PLATE

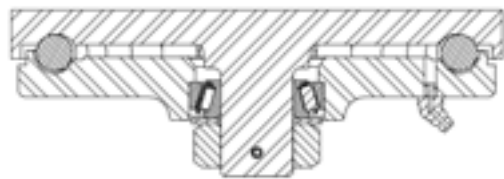

FEATURES

Swivel Section: Constructed of hot forged C-1045 steel with a 7" diameter machined load raceway featuring 5/8" diameter ball bearings with 1-1/4" tapered thrust bearing.

Legs: 1/2" x 4" legs formed and continuously welded both inside and outside for greater strength.

Kingpin: 1-1/4" integrally forged kingpin with slotted adjusting nut.

Axle: 1-1/4", Grade 5.

Lubrication: Pre-lubricated before shipping.

Wheels: 6" to 18" diameter wheels, 3" to 5" widths.

Finish: Gold Powder Coat.

APPLICATIONS

The 90 Series are used for power drawn equipment, stamping racks, trash gondolas, material delivery trailers, and towed trailers. These casters are also widely used on aircraft ground support equipment, in automotive plants and within steel mills.

BENEFITS

The 90 Series bearing raceways are precision machined and then through hardened to eliminate brinelling of the surface when the caster is subjected to shock loads. A 1-1/4" tapered thrust bearing completes the precision fit of the raceway. This caster provides high load capacity at a good value.

OPTIONS

BRAKES

Poly Lock: P*
 Wrap Around: W*
 Face Contact: F

SWIVEL LOCKS

Factory Installed: L
 Heavy Duty Demountable: DHDL
 Heavy Duty: HDL
 Foot Actuated: KL
 Demountable: DL

SEALED SWIVEL SECTION SSW

SEALED WHEELS SW

TOE GUARD TG

* For wheels with a diameter > 6"
 Contact the factory for special overall heights and finishes.
 DUAL WHEEL DESIGN AVAILABLE

EXTRA HEAVY DUTY 90 SERIES

STRAIGHT ROLLER BEARING

Diameter	Width	Material	Capacity	OAH	Swivel Radius	Swivel Lead	Part Number	Weight
6	3.00	Forged Steel	5,500	9.00	5.46	2.25	90-06301-20-1	60.00
6	4.00	H.D. Standard Polyurethane	3,000	9.00	5.61	2.25	90-06401-65-1	50.00
8	3.00	H.D. Cast Iron	4,500	11.00	6.43	2.25	90-08301-11-1	65.00
8	4.00	Forged Steel	8,000	11.00	6.56	2.25	90-08401-20-1	73.00
8	4.00	Standard Polyurethane	3,800	11.00	6.56	2.25	90-08401-60-1	63.00
10	3.00	H.D. Forged Steel	6,000	13.00	7.65	2.50	90-10301-21-1	62.00
10	3.00	Cast Iron	4,000	13.00	7.65	2.50	90-10301-11-1	61.00
10	4.00	Forged Steel	8,000	13.00	7.76	2.50	90-10401-20-1	83.00
10	4.00	Standard Polyurethane	4,200	13.00	7.76	2.50	90-10401-60-1	59.00
10	4.00	H.D. Polyurethane	5,000	13.00	7.76	2.50	90-10401-65-1	68.00
10	4.00	Mold On Rubber	1,500	13.00	7.76	2.50	90-10401-70-1	66.00
10	5.00	H.D. Standard Polyurethane	6,000	13.00	7.91	2.50	90-10501-65-1	68.00
10	5.00	H.D. Hard Polyurethane (70D)	7,200	13.00	7.91	2.50	90-10501-67-1	68.00
12	3.00	H.D. Standard Polyurethane	3,850	15.50	8.68	2.50	90-12301-65-1	57.00
12	3.50	Phenolic Resin	4,000	15.50	8.68	2.50	90-12351-30-1	60.00
12	3.50	Mold On Rubber	1,350	15.50	8.68	2.50	90-12351-70-1	63.00
12	4.00	H.D. Standard Polyurethane	5,500	15.50	8.73	2.50	90-12401-65-1	75.00
12	4.00	H.D. T/R Polyurethane	3,800	15.50	8.73	2.50	90-12401-66-1	75.00
12	4.00	H.D. Hard Polyurethane (70D)	6,600	15.50	8.73	2.50	90-12401-67-1	75.00
12	4.00	Mold On Rubber	1,600	15.50	8.73	2.50	90-12401-70-1	71.00
12	4.00	Ductile Iron	7,500	15.50	8.73	2.50	90-12401-12-1	90.00
12	5.00	H.D. Standard Polyurethane	6,250	15.50	8.86	2.50	90-12501-65-1	90.00
12	5.00	H.D. Hard Polyurethane (70D)	7,500	15.50	8.86	2.50	90-12501-67-1	90.00
12	5.00	Mold On Rubber	1,850	15.50	8.86	2.50	90-12501-70-1	88.00
12	5.00	Ductile Iron	8,000	15.50	8.86	2.50	90-12501-12-1	120.00
16	4.00	Laminated Phenolic	8,000	19.00	11.18	3.00	90-16401-35-1	80.00
16	4.00	Cast Iron	5,900	19.00	11.18	3.00	90-16401-10-1	105.00
16	4.00	H.D. Standard Polyurethane	5,900	19.00	11.18	3.00	90-16401-65-1	109.00
16	4.00	Mold On Rubber	5,900	19.00	11.18	3.00	90-16401-70-1	106.00
16	5.00	H.D. Standard Polyurethane	5,900	19.00	11.28	3.00	90-16501-65-1	115.00
16	5.00	H.D. Hard Polyurethane (70D)	5,900	19.00	11.28	3.00	90-16501-67-1	115.00
18	5.00	H.D. Standard Polyurethane	5,900	21.00	13.24	4.00	90-18501-65-1	115.00
18	5.00	H.D. Hard Polyurethane (70D)	5,900	21.00	13.24	4.00	90-18501-67-1	115.00

Capacity listed is for manual operation. For powered operations, consult factory.
 Part Numbers listed are for the swivel casters. For rigid casters, change the last digit from 1 to 2 (i.e. 90-10309-70-2)
 Estimated weight is for swivel caster. Deduct 15 pounds for rigid casters.
 All dimensions are in inches. All weights are in pounds.

CONTINUED

EXTRA HEAVY DUTY 90 SERIES

PRECISION TAPERED BEARING

Diameter	Width	Material	Capacity	OAH	Swivel Radius	Swivel Lead	Part Number	Weight
6	3.00	Forged Steel	8,000	9.00	5.46	2.25	90-06309-20-1	60.00
6	3.00	H.D. Forged Steel	8,000	9.00	5.46	2.25	90-06309-21-1	60.00
6	3.00	Standard Polyurethane	2,500	9.00	5.46	2.25	90-06309-60-1	50.00
6	4.00	H.D. Standard Polyurethane	3,000	9.00	5.61	2.25	90-06409-65-1	50.00
8	3.00	Polyurethane	2,500	11.00	6.43	2.25	90-08309-60-1	50.00
8	3.00	H.D. Cast Iron	4,500	11.00	6.43	2.25	90-08309-11-1	65.00
8	4.00	Forged Steel	8,000	11.00	6.56	2.25	90-08409-20-1	73.00
8	4.00	H.D. Forged Steel	8,000	11.00	6.56	2.25	90-08409-21-1	73.00
8	4.00	Standard Polyurethane	3,800	11.00	6.56	2.25	90-08409-60-1	63.00
10	3.00	H.D. Forged Steel	6,500	13.00	7.65	2.50	90-10309-21-1	62.00
10	3.00	Cast Iron	4,000	13.00	7.65	2.50	90-10309-11-1	61.00
10	3.00	H.D. Standard Polyurethane	3,700	13.00	7.65	2.50	90-10309-65-1	51.00
10	4.00	Forged Steel	8,000	13.00	7.76	2.50	90-10409-20-1	83.00
10	4.00	H.D. Forged Steel	8,000	13.00	7.76	2.50	90-10409-21-1	83.00
10	4.00	Standard Polyurethane	4,200	13.00	7.76	2.50	90-10409-60-1	59.00
10	4.00	H.D. Polyurethane	5,000	13.00	7.76	2.50	90-10409-65-1	68.00
10	4.00	Mold On Rubber	1,500	13.00	7.76	2.50	90-10409-70-1	66.00
10	5.00	H.D. Standard Polyurethane	6,000	13.00	7.91	2.50	90-10509-65-1	68.00
10	5.00	H.D. Hard Polyurethane (70D)	7,200	13.00	7.91	2.50	90-10509-67-1	68.00
12	3.00	H.D. Standard Polyurethane	3,850	15.50	8.68	2.50	90-12309-65-1	57.00
12	3.50	Phenolic Resin	4,000	15.50	8.68	2.50	90-12359-30-1	60.00
12	3.50	Mold On Rubber	1,350	15.50	8.68	2.50	90-12359-70-1	63.00
12	4.00	H.D. Standard Polyurethane	5,500	15.50	8.73	2.50	90-12409-65-1	75.00
12	4.00	H.D. T/R Polyurethane	3,800	15.50	8.73	2.50	90-12409-66-1	75.00
12	4.00	H.D. Hard Polyurethane (70D)	6,600	15.50	8.73	2.50	90-12409-67-1	75.00
12	4.00	Mold On Rubber	1,600	15.50	8.73	2.50	90-12409-70-1	71.00
12	4.00	Ductile Iron	7,500	15.50	8.73	2.50	90-12409-12-1	90.00
12	5.00	H.D. Standard Polyurethane	6,250	15.50	8.86	2.50	90-12509-65-1	90.00
12	5.00	H.D. Hard Polyurethane (70D)	7,500	15.50	8.86	2.50	90-12509-67-1	90.00
12	5.00	Mold On Rubber	1,850	15.50	8.86	2.50	90-12509-70-1	88.00
12	5.00	Ductile Iron	8,000	15.50	8.86	2.50	90-12509-12-1	120.00
16	4.00	Laminated Phenolic	8,000	19.00	11.18	3.00	90-16409-35-1	80.00
16	4.00	Cast Iron	7,500	19.00	11.18	3.00	90-16409-10-1	105.00
16	4.00	H.D. Standard Polyurethane	6,000	19.00	11.18	3.00	90-16409-65-1	109.00
16	4.00	Mold On Rubber	1,450	19.00	11.18	3.00	90-16409-70-1	106.00
16	5.00	H.D. Standard Polyurethane	8,000	19.00	11.28	3.00	90-16509-65-1	115.00
16	5.00	H.D. Hard Polyurethane (70D)	8,000	19.00	11.28	3.00	90-16509-67-1	115.00
18	5.00	H.D. Standard Polyurethane	8,000	21.00	13.24	4.00	90-18509-65-1	115.00
18	5.00	H.D. Hard Polyurethane (70D)	8,000	21.00	13.24	4.00	90-18509-67-1	115.00

Capacity listed is for manual operation. For powered operations, consult factory.

Part Numbers listed are for the swivel casters. For rigid casters, change the last digit from 1 to 2 (i.e. 90-10309-70-2)

Estimated weight is for swivel caster. Deduct 15 pounds for rigid casters.

All dimensions are in inches. All weights are in pounds.

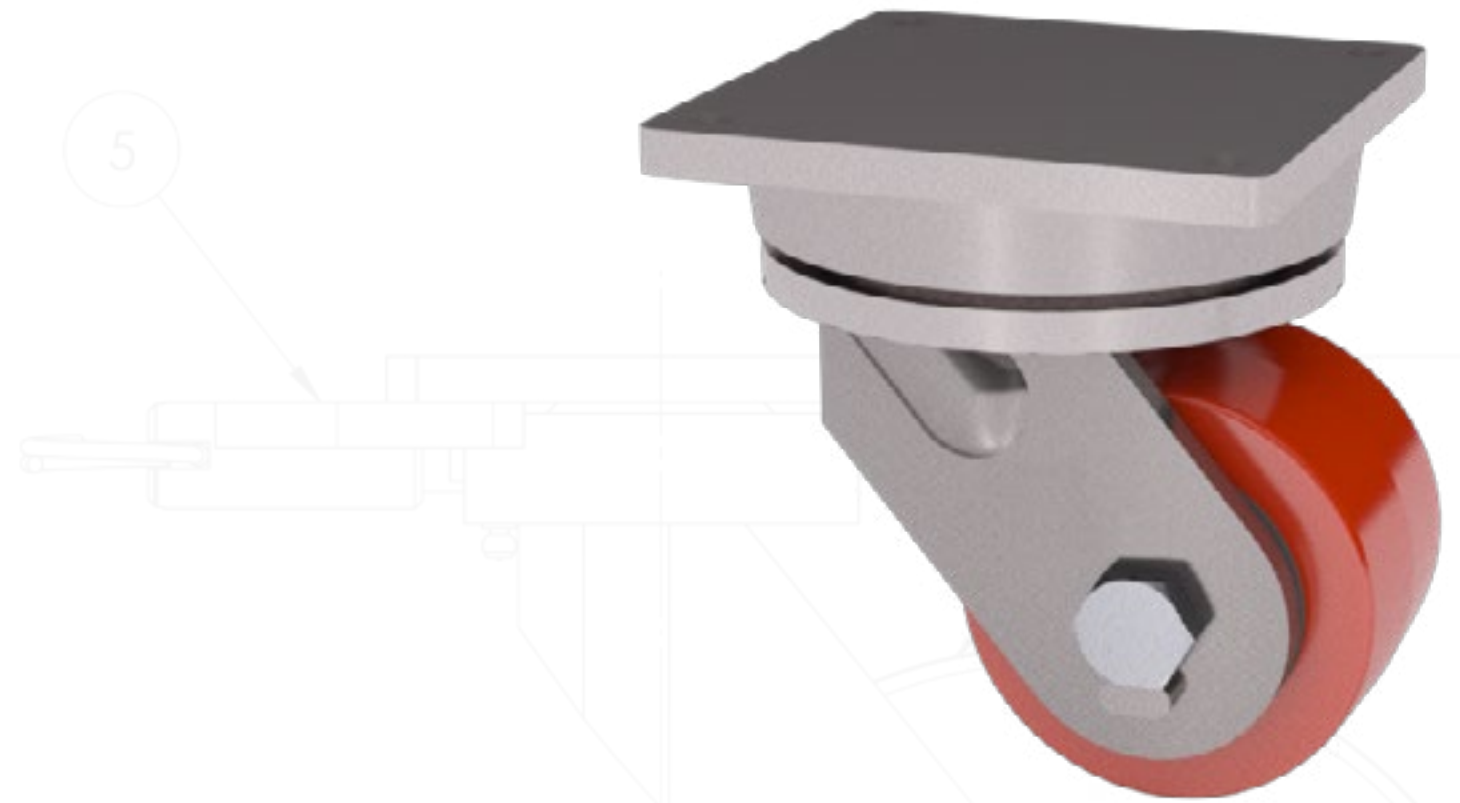

KINGPINLESS STYLE 91 SERIES CASTERS



KINGPINLESS STYLE 91 SERIES



MAXIMUM CAPACITY

20,000 lbs.

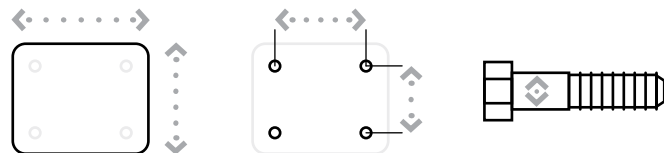

Top Plate Size	Bolt Hole Spacing	Bolt Diameter
Standard: 8.5" x 8.5"	7" x 7"	0.625"

91 SERIES TOP PLATE



FEATURES

Swivel Section: Constructed of hot forged C-1045 steel, the single ball race design features 7/8" diameter load/thrust ball bearings in a 7" diameter precision machined load raceway

Legs: 1/2" x 4" legs are formed and continuously welded both inside and outside for greater strength.

Kingpin: Kingpinless style design.

Axle: 1-1/4", Grade 5.

Lubrication: Pre-lubricated before shipping.

Wheels: 6" to 18" diameter wheels, 3" to 5" widths.

Finish: Gold Powder Coat.

Standard: Shielded swivel to reduce dust and dirt contamination.

APPLICATIONS

Specifically designed for severe applications, the 91 Series is ideal for die carts, tooling fixtures, aircraft engine stands, ground support equipment, aerospace A-frame skin dollies, portable jigs, large work platforms, mobile military equipment, aircraft maintenance stands and production line delivery trailers.

BENEFITS

The raceways are precision machined and then through hardened to eliminate brinelling of the surface. The 91 Series offers a high strength swivel section that will easily swivel under extreme loads.

OPTIONS

BRAKES

Poly Lock: P*
Wrap Around: W*
Face Contact: F

SWIVEL LOCKS

Factory Installed: L
Heavy Duty: HDL
Heavy Duty Demountable: DHDL
Demountable: DL
Foot Actuated: KL

SEALED SWIVEL SECTION SSW

SEALED WHEELS SW

TOE GUARD TG

* For wheels with a diameter > 6"
Contact the factory for special overall heights and finishes.
DUAL WHEEL DESIGN AVAILABLE

KINGPINLESS STYLE 91 SERIES

STRAIGHT ROLLER BEARING

Diameter	Width	Material	Capacity	OAH	Swivel Radius	Swivel Lead	Part Number	Weight
6	3.00	Forged Steel	6,000	9.50	5.46	2.25	91-06301-20-1	60.00
6	4.00	H.D. Standard Polyurethane	3,000	9.50	5.61	2.25	91-06401-65-1	60.00
8	4.00	Forged Steel	8,400	11.00	6.56	2.25	91-08401-20-1	73.00
8	4.00	Standard Polyurethane	3,800	11.00	6.56	2.25	91-08401-60-1	63.00
10	4.00	Forged Steel	8,400	13.00	7.76	2.50	91-10401-20-1	83.00
10	4.00	Standard Polyurethane	4,200	13.00	7.76	2.50	91-10401-60-1	59.00
10	4.00	H.D. Standard Polyurethane	5,000	13.00	7.76	2.50	91-10401-65-1	68.00
10	4.00	Mold On Rubber	1,500	13.00	7.76	2.50	91-10401-70-1	66.00
10	5.00	H.D. Standard Polyurethane	6,000	13.00	7.91	2.50	91-10501-65-1	68.00
10	5.00	H.D. Hard Polyurethane (70D)	7,200	13.00	7.91	2.50	91-10501-67-1	68.00
12	4.00	Ductile Iron	7,500	15.50	8.73	2.50	91-12401-12-1	90.00
12	4.00	H.D. Standard Polyurethane	5,500	15.50	8.73	2.50	91-12401-65-1	75.00
12	4.00	H.D. Hard Polyurethane (70D)	6,600	15.50	8.73	2.50	91-12401-67-1	75.00
12	4.00	Mold On Rubber	1,600	15.50	8.73	2.50	91-12401-70-1	71.00
12	5.00	Ductile Iron	10,000	15.50	8.86	2.50	91-12501-12-1	135.00
12	5.00	H.D. Standard Polyurethane	6,250	15.50	8.86	2.50	91-12501-65-1	90.00
12	5.00	H.D. Hard Polyurethane (70D)	7,800	15.50	8.86	2.50	91-12501-67-1	90.00
12	5.00	Mold On Rubber	1,850	15.50	8.86	2.50	91-12501-70-1	88.00
14	5.00	Cast Iron	7,000	17.50	10.31	3.00	91-14501-10-1	100.00
16	4.00	Laminated Phenolic	8,400	19.00	11.18	3.00	91-16401-35-1	80.00
16	4.00	H.D. Standard Polyurethane	6,000	19.00	11.18	3.00	91-16401-65-1	109.00
16	4.00	Mold On Rubber	1,450	19.00	11.18	3.00	91-16401-70-1	106.00
16	4.00	Cast Iron	7,500	19.00	11.18	3.00	91-16401-10-1	110.00
16	5.00	H.D. Standard Polyurethane	8,000	19.00	11.28	3.00	91-16501-65-1	115.00
16	5.00	H.D. Hard Polyurethane (70D)	8,000	19.00	11.28	3.00	91-16501-67-1	115.00
18	5.00	H.D. Standard Polyurethane	8,500	21.00	13.24	4.00	91-18501-65-1	125.00
18	5.00	H.D. Hard Polyurethane (70D)	9,000	21.00	13.24	4.00	91-18501-67-1	125.00

Capacity listed is for manual operation. For powered operations, consult factory.
Part Numbers listed are for the swivel casters.

For rigid casters, change series to 90 and change the last digit from 1 to 2 (i.e. 90-16509-67-2)
Estimated weight is for swivel caster. Deduct 15 pounds for rigid casters.

All dimensions are in inches. All weights are in pounds.

FOR TWICE THE LOAD CAPACITY, DUAL WHEELS ARE AVAILABLE. CONSULT THE FACTORY.

CONTINUED

KINGPINLESS STYLE 91 SERIES

PRECISION TAPERED BEARING

Diameter	Width	Material	Capacity	OAH	Swivel Radius	Swivel Lead	Part Number	Weight
6	3.00	Forged Steel	10,000	9.50	5.46	2.25	91-06309-20-1	60.00
6	3.00	H.D. Forged Steel	17,000	9.50	5.46	2.25	91-06309-21-1	60.00
6	4.00	H.D. Standard Polyurethane	3,000	9.50	5.61	2.25	91-06409-65-1	60.00
8	4.00	Forged Steel	10,000	11.00	6.56	2.25	91-08409-20-1	73.00
8	4.00	H.D. Forged Steel	20,000	11.00	6.56	2.25	91-08409-21-1	73.00
8	4.00	Standard Polyurethane	3,800	11.00	6.56	2.25	91-08409-60-1	63.00
10	4.00	Forged Steel	10,000	13.00	7.76	2.50	91-10409-20-1	83.00
10	4.00	H.D. Forged Steel	20,000	13.00	7.76	2.50	91-10409-21-1	83.00
10	4.00	Standard Polyurethane	4,200	13.00	7.76	2.50	91-10409-60-1	59.00
10	4.00	H.D. Standard Polyurethane	5,000	13.00	7.76	2.50	91-10409-65-1	68.00
10	4.00	Mold On Rubber	1,500	13.00	7.76	2.50	91-10409-70-1	66.00
10	5.00	H.D. Standard Polyurethane	6,000	13.00	7.91	2.50	91-10509-65-1	68.00
10	5.00	H.D. Hard Polyurethane (70D)	7,200	13.00	7.91	2.50	91-10509-67-1	68.00
12	4.00	Ductile Iron	7,500	15.50	8.73	2.50	91-12409-12-1	90.00
12	4.00	H.D. Standard Polyurethane	5,500	15.50	8.73	2.50	91-12409-65-1	75.00
12	4.00	H.D. Hard Polyurethane (70D)	6,600	15.50	8.73	2.50	91-12409-67-1	75.00
12	4.00	Mold On Rubber	1,600	15.50	8.73	2.50	91-12409-70-1	71.00
12	5.00	Ductile Iron	15,000	15.50	8.86	2.50	91-12509-12-1	135.00
12	5.00	H.D. Standard Polyurethane	6,250	15.50	8.86	2.50	91-12509-65-1	90.00
12	5.00	H.D. Hard Polyurethane (70D)	7,800	15.50	8.86	2.50	91-12509-67-1	90.00
12	5.00	Mold On Rubber	1,850	15.50	8.86	2.50	91-12509-70-1	88.00
14	5.00	Cast Iron	7,000	17.50	10.31	3.00	91-14509-10-1	100.00
16	4.00	Laminated Phenolic	9,400	19.00	11.18	3.00	91-16409-35-1	80.00
16	4.00	H.D. Standard Polyurethane	6,000	19.00	11.18	3.00	91-16409-65-1	109.00
16	4.00	Mold On Rubber	1,450	19.00	11.18	3.00	91-16409-70-1	106.00
16	4.00	Cast Iron	7,500	19.00	11.18	3.00	91-16409-10-1	110.00
16	5.00	H.D. Standard Polyurethane	8,000	19.00	11.28	3.00	91-16509-65-1	115.00
16	5.00	H.D. Hard Polyurethane (70D)	8,000	19.00	11.28	3.00	91-16509-67-1	115.00
18	5.00	H.D. Standard Polyurethane	8,500	21.00	13.24	4.00	91-18509-65-1	125.00
18	5.00	H.D. Hard Polyurethane (70D)	9,000	21.00	13.24	4.00	91-18509-67-1	125.00

Capacity listed is for manual operation. For powered operations, consult factory.

Part Numbers listed are for the swivel casters. For rigid casters, change series to 90 and change the last digit from 1 to 2 (i.e. 90-16509-67-2)

Estimated weight is for swivel caster. Deduct 15 pounds for rigid casters.

All dimensions are in inches. All weights are in pounds.

FOR TWICE THE LOAD CAPACITY, DUAL WHEELS ARE AVAILABLE. CONSULT THE FACTORY.



EXTRA HEAVY DUTY 95 SERIES CASTERS

EXTRA HEAVY DUTY 95 SERIES



MAXIMUM CAPACITY

17,000 lbs.

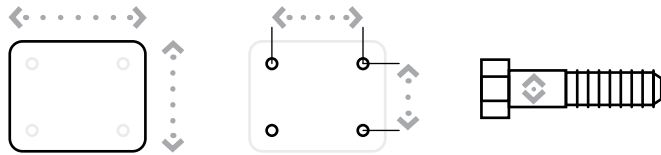

Top Plate Size	Bolt Hole Spacing	Bolt Diameter
Standard: 8.5" x 8.5"	7" x 7"	0.625"

95 SERIES TOP PLATE

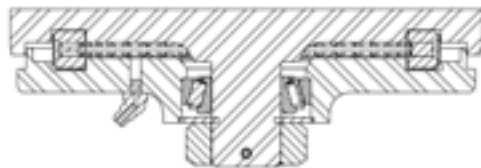

FEATURES

Swivel Section: Constructed of hot forged C-1045 steel with a 7" diameter raceway featuring precision tapered load and tapered thrust bearings.

Legs: 1/2" x 4" legs formed and continuously welded both inside and outside for greater strength.

Kingpin: 1-1/4" integrally forged kingpin with slotted adjusting nut.

Axle: 1-1/4" diameter axle.

Lubrication: Pre-lubricated before shipping.

Wheels: 6" to 18" diameter wheels.

Finish: Gold Powder Coat.

APPLICATIONS

Rugged applications include die carts, towed trailers, automotive plant equipment, aircraft maintenance stands, production line delivery trailers, paving machinery and boat dollies.

BENEFITS

The 95 Series is ideal for applications where high load capacities are required and where the caster will ensure constant use under load.

The integrally forged kingpin and slotted adjusting nut add strength and longevity to the life of the swivel section.

OPTIONS

BRAKES

Poly Lock: P*
 Wrap Around: W*
 Face Contact: F

SWIVEL LOCKS

Factory Installed: L
 Demountable: DL
 Heavy Duty: HDL
 Heavy Duty Demountable: DHDL
 Foot Actuated: KL

SEALED SWIVEL SECTION SSW

SEALED WHEELS SW

TOE GUARD TG

* For wheels with a diameter > 6"
 DUAL WHEEL DESIGN AVAILABLE

EXTRA HEAVY DUTY 95 SERIES

STRAIGHT ROLLER BEARING

Diameter	Width	Material	Capacity	OAH	Swivel Radius	Swivel Lead	Part Number	Weight
6	3.00	Forged Steel	6,000	9.00	5.46	2.25	95-06301-20-1	60.00
6	4.00	H.D. Standard Polyurethane	3,000	9.00	5.62	2.25	95-06401-65-1	50.00
8	3.00	H.D. Standard Polyurethane	3,100	11.00	6.43	2.25	95-08301-65-1	50.00
8	4.00	Forged Steel	8,400	11.00	6.56	2.25	95-08401-20-1	73.00
8	4.00	Standard Polyurethane	3,800	11.00	6.56	2.25	95-08401-60-1	63.00
10	3.00	Cast Iron	4,000	13.00	7.65	2.50	95-10301-11-1	61.00
10	4.00	H.D. Forged Steel	6,000	13.00	7.65	2.50	95-10301-21-1	62.00
10	4.00	Forged Steel	8,400	13.00	7.76	2.50	95-10401-20-1	83.00
10	4.00	Standard Polyurethane	4,200	13.00	7.76	2.50	95-10401-60-1	59.00
10	4.00	H.D. Standard Polyurethane	5,000	13.00	7.76	2.50	95-10401-65-1	68.00
10	4.00	Mold On Rubber	1,500	13.00	7.76	2.50	95-10401-70-1	66.00
10	5.00	H.D. Standard Polyurethane	6,000	13.00	7.91	2.50	95-10501-65-1	68.00
12	3.00	H.D. Standard Polyurethane	3,850	15.50	8.68	2.50	95-12301-65-1	57.00
12	3.50	Laminated Phenolic	4,700	15.50	8.68	2.50	95-12351-35-1	59.00
12	3.50	Phenolic Resin	4,000	15.50	8.68	2.50	95-12351-30-1	60.00
12	3.50	Mold On Rubber	1,350	15.50	8.68	2.50	95-12351-70-1	63.00
12	4.00	Ductile Iron	7,500	15.50	8.73	2.50	95-12401-12-1	90.00
12	4.00	H.D. Standard Polyurethane	5,500	15.50	8.73	2.50	95-12401-65-1	75.00
12	4.00	H.D. T/R Polyurethane	4,400	15.50	8.73	2.50	95-12401-66-1	75.00
12	4.00	H.D. Hard Polyurethane (70D)	6,600	15.50	8.73	2.50	95-12401-67-1	75.00
12	4.00	Mold On Rubber	1,600	15.50	8.73	2.50	95-12401-70-1	71.00
12	5.00	Ductile Iron	10,000	15.50	8.86	2.50	95-12501-12-1	130.00
12	5.00	H.D. Standard Polyurethane	6,250	15.50	8.86	2.50	95-12501-65-1	90.00
12	5.00	H.D. Hard Polyurethane (70D)	7,500	15.50	8.86	2.50	95-12501-67-1	90.00
12	5.00	Mold On Rubber	1,850	15.50	8.86	2.50	95-12501-70-1	88.00
14	5.00	Cast Iron	7,000	17.50	9.82	2.50	95-14501-10-1	100.00
16	4.00	Laminated Phenolic	8,400	19.00	11.18	3.00	95-16401-35-1	80.00
16	4.00	Cast Iron	7,500	19.00	11.18	3.00	95-16401-10-1	105.00
16	4.00	H.D. Standard Polyurethane	6,000	19.00	11.18	3.00	95-16401-65-1	109.00
16	4.00	Mold On Rubber	1,450	19.00	11.18	3.00	95-16401-70-1	106.00
16	5.00	H.D. Standard Polyurethane	8,000	19.00	11.28	3.00	95-16501-65-1	115.00
16	5.00	H.D. Hard Polyurethane (70D)	8,000	19.00	11.28	3.00	95-16501-67-1	115.00
18	5.00	H.D. Standard Polyurethane	8,000	21.00	13.24	4.00	95-18501-65-1	120.00
18	5.00	H.D. Hard Polyurethane (70D)	8,000	21.00	13.24	4.00	95-18501-67-1	120.00

Capacity listed is for manual operation. For powered operations, consult factory.

Part Numbers listed are for the swivel casters.

For rigid casters, change series to 90 and change the last digit from 1 to 2 (i.e. 90-16509-67-2)

Estimated weight is for swivel caster. Deduct 20 pounds for rigid casters.

All dimensions are in inches. All weights are in pounds.

CONTINUED

EXTRA HEAVY DUTY 95 SERIES

PRECISION TAPERED BEARING

Diameter	Width	Material	Capacity	OAH	Swivel Radius	Swivel Lead	Part Number	Weight
6	3.00	Forged Steel	10,000	9.00	5.46	2.25	95-06309-20-1	60.00
6	3.00	H.D. Forged Steel	17,000	9.00	5.46	2.25	95-06309-21-1	60.00
6	3.00	Standard Polyurethane	2,500	9.00	5.46	2.25	95-06309-60-1	50.00
6	4.00	H.D. Standard Polyurethane	3,000	9.00	5.62	2.25	95-06409-65-1	50.00
8	3.00	H.D. Standard Polyurethane	3,100	11.00	6.43	2.25	95-08309-65-1	50.00
8	4.00	Forged Steel	10,000	11.00	6.56	2.25	95-08409-20-1	73.00
8	4.00	H.D. Forged Steel	17,000	11.00	6.56	2.25	95-08409-21-1	73.00
8	4.00	Standard Polyurethane	3,800	11.00	6.56	2.25	95-08409-60-1	63.00
10	3.00	Cast Iron	4,000	13.00	7.65	2.50	95-10309-11-1	61.00
10	4.00	H.D. Forged Steel	6,000	13.00	7.65	2.50	95-10309-21-1	62.00
10	4.00	Polyurethane	3,000	13.00	7.65	2.50	95-10309-60-1	51.00
10	4.00	H.D. Forged Steel	17,000	13.00	7.76	2.50	95-10309-21-1	83.00
10	4.00	Forged Steel	10,000	13.00	7.76	2.50	95-10409-20-1	83.00
10	4.00	Standard Polyurethane	4,200	13.00	7.76	2.50	95-10409-60-1	59.00
10	4.00	H.D. Standard Polyurethane	5,000	13.00	7.76	2.50	95-10409-65-1	68.00
10	4.00	Mold On Rubber	1,500	13.00	7.76	2.50	95-10409-70-1	66.00
10	5.00	H.D. Standard Polyurethane	6,000	13.00	7.91	2.50	95-10509-65-1	68.00
12	3.00	H.D. Standard Polyurethane	3,850	15.50	8.68	2.50	95-12309-65-1	57.00
12	3.50	Laminated Phenolic	4,700	15.50	8.68	2.50	95-12359-35-1	59.00
12	3.50	Phenolic Resin	4,000	15.50	8.68	2.50	95-12359-30-1	60.00
12	3.50	Mold On Rubber	1,350	15.50	8.68	2.50	95-12359-70-1	63.00
12	4.00	Ductile Iron	7,500	15.50	8.73	2.50	95-12409-12-1	90.00
12	4.00	H.D. Standard Polyurethane	5,500	15.50	8.73	2.50	95-12409-65-1	75.00
12	4.00	H.D. T/R Polyurethane	4,400	15.50	8.73	2.50	95-12409-66-1	75.00
12	4.00	H.D. Hard Polyurethane (70D)	6,600	15.50	8.73	2.50	95-12409-67-1	75.00
12	4.00	Mold On Rubber	1,600	15.50	8.73	2.50	95-12409-70-1	71.00
12	5.00	Ductile Iron	15,000	15.50	8.86	2.50	95-12509-12-1	130.00
12	5.00	H.D. Standard Polyurethane	6,250	15.50	8.86	2.50	95-12509-65-1	90.00
12	5.00	H.D. Hard Polyurethane (70D)	7,500	15.50	8.86	2.50	95-12509-67-1	90.00
12	5.00	Mold On Rubber	1,850	15.50	8.86	2.50	95-12509-70-1	88.00
14	5.00	Cast Iron	7,000	17.50	9.82	2.50	95-14509-10-1	100.00

CONTINUED

EXTRA HEAVY DUTY 95 SERIES

PRECISION TAPERED BEARING

Diameter	Width	Material	Capacity	OAH	Swivel Radius	Swivel Lead	Part Number	Weight
16	4.00	Laminated Phenolic	8,400	19.00	11.18	3.00	95-16409-35-1	80.00
16	4.00	Cast Iron	7,500	19.00	11.18	3.00	95-16409-10-1	105.00
16	4.00	H.D. Standard Polyurethane	6,000	19.00	11.18	3.00	95-16409-65-1	109.00
16	4.00	Mold On Rubber	1,450	19.00	11.18	3.00	95-16409-70-1	106.00
16	5.00	H.D. Standard Polyurethane	8,000	19.00	11.28	3.00	95-16509-65-1	115.00
16	5.00	H.D. Hard Polyurethane (70D)	8,000	19.00	11.28	3.00	95-16509-67-1	115.00
18	5.00	H.D. Standard Polyurethane	8,000	21.00	13.24	4.00	95-18509-65-1	120.00
18	5.00	H.D. Hard Polyurethane (70D)	9,000	21.00	13.24	4.00	95-18509-67-1	120.00

Capacity listed is for manual operation. For powered operations, consult factory.
Part Numbers listed are for the swivel casters. For rigid casters, change series to 90 and change the last digit from 1 to 2 (i.e. 90-16509-67-2)
Estimated weight is for swivel caster. Deduct 20 pounds for rigid casters.
All dimensions are in inches. All weights are in pounds.

SUPER HEAVY DUTY 97 SERIES



MAXIMUM CAPACITY

20,000 lbs.

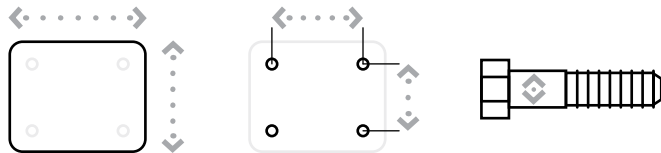

Top Plate Size	Bolt Hole Spacing	Bolt Diameter
Standard: 8.5" x 8.5"	7" x 7"	0.625"

97 SERIES TOP PLATE

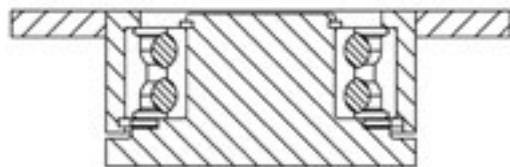

FEATURES

- Swivel Section:** Sealed precision ball bearing with hardened raceways and neoprene seals.
- Legs:** 1/2" x 4" steel, formed and continuously welded on the inside and outside to the yoke base.
- Kingpin:** Kingpinless style design.
- Axle:** 1-1/4", Grade 5.
- Lubrication:** Sealed ball bearings are lubricated and require zero maintenance.
- Wheels:** 6" to 20" diameter wheels, 3" to 5" widths.
- Finish:** Gold Powder Coat.

APPLICATIONS

Suitable for continuous use, power drawn applications, Automated Guided Vehicles (AGV's), aircraft wing and spar tooling, material carts, chassis rack carts, and aircraft maintenance stands, aero engine stands, large boat dollies.

BENEFITS

The 97 Series is maintenance free with sealed precision ball bearings in the swivel section and in the wheels. The high hardness and precision machining tolerances of the swivel section allow for an even distribution of load and longer life in continuous-use applications. Better maneuverability and ease of movement.

OPTIONS

- BRAKES**
- Poly Lock: P*
- Wrap Around: W*
- Face Contact: F
- SWIVEL LOCKS**
- Factory Installed: L
- Heavy Duty: HDL
- Heavy Duty Demountable: DHDL
- Demountable: DL
- Foot Actuated: KL
- SEALED SWIVEL SECTION** SSW
- SEALED WHEELS** SW
- TOE GUARD** TG

* For wheels with a diameter > 6"
Contact the factory for special overall heights and finishes.
DUAL WHEEL DESIGN AVAILABLE

SUPER HEAVY DUTY 97 SERIES

PRECISION TAPERED BEARING

Diameter	Width	Material	Capacity	OAH	Swivel Radius	Swivel Lead	Part Number	Weight
6	4.00	Forged Steel	10,000	9.50	5.62	2.25	97-06309-20-1	
6	4.00	H.D. Forged Steel	10,000	9.50	5.62	2.25	97-06309-21-1	
6	4.00	H.D. Standard Polyurethane	3,000	9.50	5.62	2.25	97-06409-65-1	
6	4.00	HPPT Polyurethane	4,600	9.50	5.62	2.25	97-06409-95-1	
6	4.00	H.D. T/R-95 Polyurethane	4,140	9.50	5.62	2.25	97-06409-96-1	
8	4.00	Forged Steel	10,000	11.00	6.56	2.25	97-08409-20-1	
8	4.00	H.D. Forged Steel	10,000	11.00	6.56	2.25	97-08409-21-1	
8	4.00	Standard Polyurethane	3,800	11.00	6.56	2.25	97-08409-60-1	
10	4.00	Forged Steel	10,000	13.00	7.76	2.50	97-10409-20-1	
10	4.00	H.D. Forged Steel	10,000	13.00	7.76	2.50	97-10409-21-1	
10	4.00	Standard Polyurethane	4,200	13.00	7.76	2.50	97-10409-60-1	
10	4.00	H.D. Standard Polyurethane	5,000	13.00	7.76	2.50	97-10409-65-1	
10	4.00	HPPT Polyurethane	6,500	13.00	7.76	2.50	97-10409-95-1	
10	4.00	H.D. T/R-95 Polyurethane	5,850	13.00	7.76	2.50	97-10409-96-1	
10	5.00	H.D. Standard Polyurethane	6,000	13.00	7.91	2.50	97-10509-65-1	
10	5.00	HPPT Polyurethane	7,900	13.00	7.91	2.50	97-10509-95-1	
10	5.00	H.D. T/R-95 Polyurethane	7,100	13.00	7.91	2.50	97-10509-96-1	
12	4.00	Ductile Iron	7,500	15.50	8.73	2.50	97-12409-12-1	
12	4.00	H.D. Standard Polyurethane	5,500	15.50	8.73	2.50	97-12409-65-1	
12	4.00	HPPT Polyurethane	7,000	15.50	8.73	2.50	97-12409-95-1	
12	4.00	H.D. T/R-95 Polyurethane	6,300	15.50	8.73	2.50	97-12409-96-1	
12	5.00	Ductile Iron	10,000	15.50	8.86	2.50	97-12509-12-1	
12	5.00	H.D. Standard Polyurethane	6,250	15.50	8.86	2.50	97-12509-65-1	
12	5.00	HPPT Polyurethane	8,400	15.50	8.86	2.50	97-12509-95-1	
12	5.00	H.D. T/R-95 Polyurethane	7,560	15.50	8.86	2.50	97-12509-96-1	
16	4.00	Laminated Phenolic	9,400	19.00	11.18	3.00	97-16409-35-1	
16	4.00	H.D. Standard Polyurethane	6,000	19.00	11.18	3.00	97-16409-65-1	
16	4.00	HPPT Polyurethane	8,125	19.00	11.18	3.00	97-16409-95-1	
16	4.00	H.D. T/R-95 Polyurethane	7,300	19.00	11.18	3.00	97-16409-96-1	
16	5.00	H.D. Standard Polyurethane	8,000	19.00	11.28	3.00	97-16509-65-1	
16	5.00	HPPT Polyurethane	9,125	19.00	11.28	3.00	97-16509-95-1	
16	5.00	H.D. T/R-95 Polyurethane	8,200	19.00	11.28	3.00	97-16509-96-1	
18	5.00	H.D. Standard Polyurethane	8,500	21.00	13.24	4.00	97-18509-65-1	
18	5.00	HPPT Polyurethane	9,500	21.00	13.24	4.00	97-18509-95-1	
18	5.00	H.D. T/R-95 Polyurethane	8,550	21.00	13.24	4.00	97-18509-96-1	

Capacity listed is for manual operation. For powered operations, consult factory.
Part Numbers listed are for the swivel casters.
For rigid casters, change the last digit from 1 to 2 (i.e. 97-16509-67-2)
Estimated weight is for swivel caster. Deduct 15 pounds for rigid casters.
All dimensions are in inches. All weights are in pounds.

FOR TWICE THE LOAD CAPACITY, DUAL WHEELS ARE AVAILABLE. CONSULT THE FACTORY.

CONTINUED

SUPER HEAVY DUTY 97 SERIES

PRECISION TAPERED BEARING

Diameter	Width	Material	Capacity	OAH	Swivel Radius	Swivel Lead	Part Number	Weight
20	5.00	H.D. Standard Polyurethane	9,000	23.00	14.22	4.00	97-20509-65-1	
20	5.00	HPPT Polyurethane	11,250	23.00	14.22	4.00	97-20509-95-1	
20	5.00	H.D. T/R-95 Polyurethane	10,000	23.00	14.22	4.00	97-20509-96-1	

PRECISION TAPERED BEARING (97HD)

Diameter	Width	Material	Capacity	OAH	Swivel Radius	Swivel Lead	Part Number	Weight
6	4.00	Forged Steel	10,000	10.50	5.62	2.25	97HD-06309-20-1	
6	4.00	H.D. Forged Steel	17,000	10.50	5.62	2.25	97HD-06309-21-1	
6	4.00	H.D. Standard Polyurethane	3,000	10.50	5.62	2.25	97HD-06409-65-1	
6	4.00	HPPT Polyurethane	4,600	10.50	5.62	2.25	97HD-06409-95-1	
6	4.00	H.D. T/R-95 Polyurethane	4,140	10.50	5.62	2.25	97HD-06409-96-1	
8	4.00	Forged Steel	10,000	12.50	6.56	2.25	97HD-08409-20-1	
8	4.00	H.D. Forged Steel	20,000	12.50	6.56	2.25	97HD-08409-21-1	
8	4.00	Standard Polyurethane	3,800	12.50	6.56	2.25	97HD-08409-60-1	
10	4.00	Forged Steel	10,000	14.50	7.76	2.50	97HD-10409-20-1	
10	4.00	H.D. Forged Steel	20,000	14.50	7.76	2.50	97HD-10409-21-1	
10	4.00	Standard Polyurethane	4,200	14.50	7.76	2.50	97HD-10409-60-1	
10	4.00	H.D. Standard Polyurethane	5,000	14.50	7.76	2.50	97HD-10409-65-1	
10	4.00	HPPT Polyurethane	6,500	14.50	7.76	2.50	97HD-10409-95-1	
10	4.00	H.D. T/R-95 Polyurethane	5,850	14.50	7.76	2.50	97HD-10409-96-1	
10	5.00	H.D. Standard Polyurethane	6,000	14.50	7.91	2.50	97HD-10509-65-1	
10	5.00	HPPT Polyurethane	7,900	14.50	7.91	2.50	97HD-10509-95-1	
10	5.00	H.D. T/R-95 Polyurethane	7,100	14.50	7.91	2.50	97HD-10509-96-1	
12	4.00	Ductile Iron	7,500	16.50	8.73	2.50	97HD-12409-12-1	
12	4.00	H.D. Standard Polyurethane	5,500	16.50	8.73	2.50	97HD-12409-65-1	
12	4.00	HPPT Polyurethane	7,000	16.50	8.73	2.50	97HD-12409-95-1	
12	4.00	H.D. T/R-95 Polyurethane	6,300	16.50	8.73	2.50	97HD-12409-96-1	
12	5.00	Ductile Iron	15,000	16.50	8.86	2.50	97HD-12509-12-1	
12	5.00	H.D. Standard Polyurethane	6,250	16.50	8.86	2.50	97HD-12509-65-1	
12	5.00	HPPT Polyurethane	8,400	16.50	8.86	2.50	97HD-12509-95-1	
12	5.00	H.D. T/R-95 Polyurethane	7,560	16.50	8.86	2.50	97HD-12509-96-1	
16	4.00	Laminated Phenolic	9,400	20.50	11.18	3.00	97HD-16409-35-1	
16	4.00	H.D. Standard Polyurethane	6,000	20.50	11.18	3.00	97HD-16409-65-1	
16	4.00	HPPT Polyurethane	8,125	20.50	11.18	3.00	97HD-16409-95-1	
16	4.00	H.D. T/R-95 Polyurethane	7,300	20.50	11.18	3.00	97HD-16409-96-1	
16	5.00	H.D. Standard Polyurethane	8,000	20.50	11.28	3.00	97HD-16509-65-1	
16	5.00	HPPT Polyurethane	9,125	20.50	11.28	3.00	97HD-16509-95-1	
16	5.00	H.D. T/R-95 Polyurethane	8,200	20.50	11.28	3.00	97HD-16509-96-1	

CONTINUED

SUPER HEAVY DUTY 97 SERIES

PRECISION TAPERED BEARING (97HD)

Diameter	Width	Material	Capacity	OAH	Swivel Radius	Swivel Lead	Part Number	Weight
18	5.00	H.D. Standard Polyurethane	8,500	22.50	13.24	4.00	97HD-18509-65-1	
18	5.00	HPPT Polyurethane	9,500	22.50	13.24	4.00	97HD-18509-95-1	
18	5.00	H.D. T/R-95 Polyurethane	8,550	22.50	13.24	4.00	97HD-18509-96-1	
20	5.00	Forged Steel	9,000	24.50	14.22	4.00	97HD-20509-65-1	
20	5.00	H.D. Forged Steel	11,250	24.50	14.22	4.00	97HD-20509-95-1	
20	5.00	Standard Polyurethane	10,000	24.50	14.22	4.00	97HD-20509-96-1	

Capacity listed is for manual operation. For powered operations, consult factory.
Part Numbers listed are for the swivel casters.
For rigid casters, change the last digit from 1 to 2 (i.e. 97-16509-67-2)
Estimated weight is for swivel caster. Deduct 15 pounds for rigid casters.
All dimensions are in inches. All weights are in pounds.

FOR TWICE THE LOAD CAPACITY, DUAL WHEELS ARE AVAILABLE. CONSULT THE FACTORY.

CONTINUED

SUPER HEAVY DUTY 99 SERIES



MAXIMUM CAPACITY

35,000 lbs.

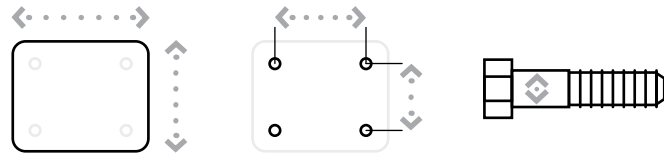

Top Plate Size	Bolt Hole Spacing	Bolt Diameter
Standard: 14" x 14"	12" x 12"	0.75"

99 SERIES TOP PLATE

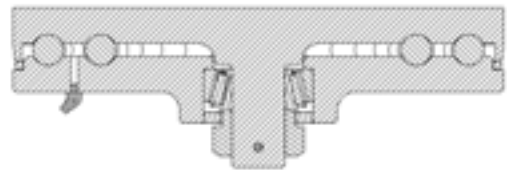

FEATURES

Swivel Section: Machined from C-1045 hot forged steel which has been precision machined for bearings. The swivel section features dual 9" and 12" diameter through hardened load races that use 7/8" diameter steel balls.

Legs: 3/4" legs are continuously welded both inside and outside for the greatest strength.

Kingpin: 1-1/2" diameter kingpin integrally forged into top plate features a slotted adjusting nut and heavy-duty 1-1/2" sealed tapered thrust bearing.

Axle: 2" alloy steel

Lubrication: Pre-lubricated before shipping.

Wheels: Available in single and dual-wheel configurations. Single wheel diameters range from 12" to 28". Dual wheel diameters range from 10" to 22" as standard.

Finish: Black Powder Coat.

APPLICATIONS

Optimal for die handling, marine and automotive applications, the 99 Series also meets the needs for aerospace and aircraft ground support equipment.

BENEFITS

The 99 Series platform with heavy-duty swivel casters is the ideal choice when payload protection far exceeds the capacity of the caster. The dual load race design assures smooth rotation of the caster and superior load capacity. Priced at production prices, the series offers flexibility and comfort in product design.

OPTIONS

BRAKES

Poly Lock: P
Face Contact: F

SWIVEL LOCKS

Vertical Mounted: V
Heavy Duty: HDL

SEALED WHEELS SW

TOE GUARD TG

** For wheels with a diameter > 6"
99 series swivel sections are used as a platform for many custom designed applications. Please consult the factory.*

SUPER HEAVY DUTY 99 SERIES

STRAIGHT ROLLER BEARING

Diameter	Width	Material	Capacity	OAH	Swivel Radius	Swivel Lead	Part Number	Weight
12	5.00	Ductile Iron	18,000	16.50	9.34	3.00	99-12501-12-1	291.00
12	5.00	H.D. Hard Polyurethane (70D)	7,500	16.50	9.34	3.00	99-12501-67-1	196.00
15	9.00	H.D. Soft Polyurethane	8,700	19.50	11.88	3.50	99-15901-69-1	
18	9.00	H.D. Soft Polyurethane	10,900	22.00	14.23	4.50	99-18901-69-1	305.00
22	8.00	H.D. Soft Polyurethane	11,000	26.00	16.98	5.50	99-22801-69-1	
22	12.00	H.D. Soft Polyurethane	17,500	26.00	17.56	5.50	99-22121-69-1	
28	12.00	H.D. Soft Polyurethane	21,000	32.00	20.88	6.00	99-28121-69-1	
28	16.00	H.D. Soft Polyurethane	29,000	32.00	21.54	6.00	99-28161-69-1	

THE 99 SERIES PLATFORM CAN BE HIGHLY CUSTOMIZED FOR A BROAD RANGE OF APPLICATIONS.
All dimensions are in inches. All weights are in pounds.

CASTERS DUAL WHEEL



MAXIMUM CAPACITY

50,000 lbs.

FEATURES

Dual wheel casters are designed for heavy duty, extra heavy duty and super duty applications. Constructed of our popular hot forged C-1045 steel swivel sections, these dual wheel casters offer the highest possible capacity at the lowest overall height. The casters feature legs that are welded to a unique skirt design for greater strength and longevity.

APPLICATIONS

Excellent for tow lines, industrial platform trucks, rugged industrial functions and other severe abuse applications.

BENEFITS

The large footprint for a greater distribution of load on the floor. Additionally, the larger casters have a vertical center leg to further enhance the load distribution. Less effort is needed when changing direction as the design allows the wheels to rotate at variable rates to compensate for the shorter radius in the arc.

OPTIONS

BRAKES

Poly Lock: P
Double Side: DS
Face Contact: F

SWIVEL LOCKS

Factory Installed: L
Demountable: DL
Heavy Duty: HDL
Heavy Duty Demountable: DHDL
Foot Actuated: KL

SEALED SWIVEL SECTION SSW

TOE GUARD TG

CASTERS DUAL WHEEL

STRAIGHT ROLLER BEARING (KINGPIN)

Diameter	Width	Material	Capacity	OAH	Swivel Radius	Swivel Lead	Series	Part Number	Weight
4	1.50	Phenolic Resin	1,200	5.62	3.89	1.50	50	52-04101-30-1	9.50
4	1.50	Standard Polyurethane	1,350	5.62	3.89	1.50	50	52-04101-60-1	11.00
5	1.50	Phenolic Resin	1,200	6.50	4.57	1.75	50	52-05101-30-1	10.50
5	1.50	Standard Polyurethane	1,400	6.50	4.57	1.75	50	52-05101-60-1	11.50
6	2.00	Cast Iron	1,500	7.50	5.75	2.25	50	52-06201-10-1	21.00
6	2.00	Forged Steel	1,500	7.50	5.75	2.25	50	52-06201-20-1	20.00
6	2.00	Phenolic Resin	1,500	7.50	5.75	2.25	50	52-06201-30-1	13.00
6	2.00	Standard Polyurethane	1,500	7.50	5.75	2.25	50	52-06201-60-1	18.00
6	2.00	Mold On Rubber	820	7.50	5.75	2.25	50	52-06201-70-1	12.50
3	1.50	Standard Polyurethane	900	5.25	3.44	1.50	60	62-03101-60-1	9.00
4	1.50	Phenolic Resin	1,200	5.62	3.89	1.50	60	62-04101-30-1	9.50
4	1.50	Standard Polyurethane	1,350	5.62	3.89	1.50	60	62-04101-60-1	11.00
5	1.50	Phenolic Resin	1,200	6.50	4.57	1.75	60	62-05101-30-1	10.50
5	1.50	Standard Polyurethane	1,400	6.50	4.57	1.75	60	62-05101-60-1	11.50
4	1.50	Forged Steel	2,000	5.50	4.57	2.25	65	66-04101-20-1	14.00
4	2.00	Phenolic Resin	1,600	5.50	4.85	2.25	65	66-04201-30-1	11.00
4	2.00	Standard Polyurethane	1,500	5.50	4.85	2.25	65	66-04201-60-1	12.00
5	2.00	Forged Steel	2,000	6.50	5.30	2.25	65	66-05201-20-1	17.00
5	2.00	Phenolic Resin	2,000	6.50	5.30	2.25	65	66-05201-30-1	11.50
5	2.00	Standard Polyurethane	2,000	6.50	5.30	2.25	65	66-05201-60-1	15.00
6	2.00	Cast Iron	2,000	7.50	5.75	2.25	65	66-06201-10-1	21.00
6	2.00	Forged Steel	2,000	7.50	5.75	2.25	65	66-06201-20-1	20.00
6	2.00	Phenolic Resin	2,000	7.50	5.75	2.25	65	66-06201-30-1	13.00
6	2.00	Standard Polyurethane	2,000	7.50	5.75	2.25	65	66-06201-60-1	18.00
6	2.00	Mold on Rubber	820	7.50	5.75	2.25	65	66-06201-70-1	12.50
8	2.00	Cast Iron	2,000	10.12	6.68	2.25	65	66-08201-10-1	26.00
8	2.00	Phenolic Resin	2,000	10.12	6.68	2.25	65	66-08201-30-1	18.00
8	2.00	Standard Polyurethane	2,000	10.12	6.68	2.25	65	66-08201-60-1	25.00
8	2.00	Mold On Rubber	1,000	10.12	6.68	2.25	65	66-08201-70-1	35.00

Capacity listed is for manual operation. For powered operations, consult factory.

Part Numbers listed are for the swivel casters. For rigid casters, change the last digit from 1 to 2 (i.e. 96-10509-65-2)

See series codes for top plate and bolt hole dimensions.

All dimensions are in inches. All weights are in pounds.

CONTINUED

CASTERS DUAL WHEEL

STRAIGHT ROLLER BEARING (KINGPIN)

Diameter	Width	Material	Capacity	OAH	Swivel Radius	Swivel Lead	Series	Part Number	Weight
6	2.50	Mold On Rubber	1,080	8.00	6.16	2.25	70	72-06251-70-1	37.00
6	2.50	Standard Polyurethane	3,500	8.00	6.16	2.25	70	72-06251-60-1	40.00
6	2.50	Phenolic Resin	3,500	8.00	6.16	2.25	70	72-06251-30-1	26.00
6	2.50	Cast Iron	3,500	8.00	6.16	2.25	70	72-06251-10-1	37.00
8	2.50	Mold On Rubber	1,340	10.50	7.25	2.50	70	72-08251-70-1	38.00
8	2.50	Standard Polyurethane	3,500	10.50	7.25	2.50	70	72-08251-60-1	40.00
8	2.50	Phenolic Resin	3,500	10.50	7.25	2.50	70	72-08251-30-1	30.00
10	2.50	Mold On Rubber	1,550	12.50	8.16	2.50	70	72-10251-70-1	42.00
10	2.50	Standard Polyurethane	3,500	12.50	8.16	2.50	70	72-10251-60-1	52.00
10	2.50	Phenolic Resin	3,500	12.50	8.16	2.50	70	72-10251-30-1	35.00
12	2.50	Mold On Rubber	1,800	14.00	9.09	2.50	70	72-12251-70-1	51.00
12	2.50	Standard Polyurethane	3,500	14.00	9.09	2.50	70	72-12251-60-1	58.00
12	2.50	Phenolic Resin	3,500	14.00	9.09	2.50	70	72-12251-30-1	43.00
6	3.00	Standard Polyurethane	4,100	9.00	6.54	2.50	80	82-06301-60-1	44.00
6	3.00	Phenolic Resin	4,000	9.00	6.54	2.50	80	82-06301-30-1	39.00
6	3.00	Forged Steel	5,000	9.00	6.54	2.50	80	82-06301-20-1	65.00
8	3.00	Standard Polyurethane	5,000	11.00	7.40	2.50	80	82-08301-60-1	50.00
8	3.00	Phenolic Resin	5,000	11.00	7.40	2.50	80	82-08301-30-1	40.00
8	3.00	Forged Steel	5,000	11.00	7.40	2.50	80	82-08301-20-1	62.00
8	3.00	Cast Iron	5,000	11.00	7.40	2.50	80	82-08301-10-1	62.00
10	3.00	Standard Polyurethane	6,000	13.00	8.29	2.50	85	86-10301-60-1	58.00
10	3.00	Phenolic Resin	5,800	13.00	8.29	2.50	85	86-10301-30-1	45.00
10	3.00	H.D. Forged Steel	10,000	13.00	8.29	2.50	85	86-10301-21-1	81.00
10	3.00	Cast Iron	6,000	13.00	8.29	2.50	85	86-10301-10-1	71.00
6	3.00	Forged Steel	11,000	9.00	6.54	2.50	95	96-06301-20-1	85.00
8	4.00	Standard Polyurethane	7,600	11.00	7.92	2.50	95	96-08401-60-1	75.00
10	3.00	H.D. Standard Polyurethane	7,400	13.00	8.29	2.50	95	96-10301-65-1	88.00
10	3.00	Laminated Phenolic	6,000	13.00	8.29	2.50	95	96-10301-35-1	67.00
10	3.00	H.D. Forged Steel	12,000	13.00	8.29	2.50	95	96-10301-21-1	123.00
10	4.00	H.D. Standard Polyurethane	10,000	13.00	8.76	2.50	95	96-10401-65-1	103.00
10	4.00	Standard Polyurethane	8,400	13.00	8.76	2.50	95	96-10401-60-1	90.00
10	5.00	H.D. Standard Polyurethane	12,000	13.00	9.32	2.50	95	96-10501-65-1	103.00
12	3.00	H.D. Standard Polyurethane	7,700	15.50	9.2	2.50	95	96-12301-65-1	108.00
12	3.50	Laminated Phenolic	8,500	15.50	9.52	2.50	95	96-12351-35-1	97.00
12	4.00	H.D. Standard Polyurethane	11,000	15.50	9.52	2.50	95	96-12401-65-1	120.00
12	4.00	H.D. Hard Polyurethane (70D)	13,000	15.50	9.52	2.50	95	96-12401-67-1	100.00
12	5.00	H.D. Standard Polyurethane	12,500	15.50	10.14	2.50	95	96-12501-65-1	150.00
12	5.00	H.D. Hard Polyurethane (70D)	15,000	15.50	10.14	2.50	95	96-12501-67-1	130.00

CONTINUED

CASTERS DUAL WHEEL

STRAIGHT ROLLER BEARING (KINGPIN)

Diameter	Width	Material	Capacity	OAH	Swivel Radius	Swivel Lead	Series	Part Number	Weight
10	4.00	H.D. Forged Steel	35,000	14.50		3.00	99	2-99-10401-21-1	255.00
12	5.00	Ductile Iron	35,000	16.50		3.00	99	2-99-12501-12-1	436.00
12	5.00	H.D. Hard Polyurethane (70D)	15,000	16.50		3.00	99	2-99-12501-67-1	244.46
18	9.00	H.D. Soft Polyurethane	21,800	22.00		4.50	99	2-99-18901-69-1	533.88
22	8.00	H.D. Soft Polyurethane	23,000	26.00		5.50	99	2-99-22801-69-1	
22	12.00	H.D. Soft Polyurethane	35,000	26.00		5.50	99	2-99-22121-69-1	1,048.00

STRAIGHT ROLLER BEARING (KINGPINLESS)

Diameter	Width	Material	Capacity	OAH	Swivel Radius	Swivel Lead	Series	Part Number	Weight
4	1.50	Phenolic Resin	1,200	5.63	4.57	2.25	51	2-51-04101-30-1	9.50
4	1.50	Standard Polyurethane	1,350	5.63	4.57	2.25	51	2-51-04101-60-1	11.00
5	1.50	Phenolic Resin	1,200	6.50	5.04	2.25	51	2-51-05101-30-1	10.50
5	1.50	Standard Polyurethane	1,400	6.50	5.04	2.25	51	2-51-05101-60-1	11.50
6	2.00	Cast Iron	1,500	7.50	5.97	2.50	51	2-51-06201-10-1	21.00
6	2.00	Forged Steel	1,500	7.50	5.97	2.50	51	2-51-06201-20-1	20.00
6	2.00	Phenolic Resin	1,500	7.50	5.97	2.50	51	2-51-06201-30-1	13.00
6	2.00	Polyurethane	1,500	7.50	5.97	2.50	51	2-51-06201-60-1	18.00
6	2.00	Mold On Rubber	820	7.50	5.97	2.50	51	2-51-06201-70-1	12.50
3	1.50	Standard Polyurethane	900	5.25	3.44	1.50	61	2-61-03101-60-1	9.00
4	1.50	Phenolic Resin	1,200	5.63	3.88	1.50	61	2-61-04101-30-1	9.50
4	1.50	Standard Polyurethane	1,350	5.63	3.88	1.50	61	2-61-04101-60-1	11.00
4	2.00	Phenolic Resin	1,600	5.88	4.85	2.25	61	2-61-04201-30-1	11.00
4	2.00	Standard Polyurethane	1,500	5.88	4.85	2.25	61	2-61-04201-60-1	12.00
5	1.50	Phenolic Resin	1,200	6.50	4.57	1.75	61	2-61-05101-30-1	10.50
5	1.50	Standard Polyurethane	1,400	6.50	4.57	1.75	61	2-61-05101-60-1	11.50
5	2.00	Forged Steel	3,000	6.88	5.29	2.25	61	2-61-05201-20-1	17.00
5	2.00	Phenolic Resin	2,000	6.88	5.29	2.25	61	2-61-05201-30-1	11.50
5	2.00	Standard Polyurethane	2,100	6.88	5.29	2.25	61	2-61-05201-60-1	15.00
5	2.00	Mold On Rubber	800	6.88	5.29	2.25	61	2-61-05201-70-1	12.50
6	2.00	Cast Iron	2,600	7.88	5.74	2.25	61	2-61-06201-10-1	21.00
6	2.00	Forged Steel	3,000	7.88	5.74	2.25	61	2-61-06201-20-1	20.00
6	2.00	Phenolic Resin	2,400	7.88	5.74	2.25	61	2-61-06201-30-1	13.00
6	2.00	Standard Polyurethane	2,400	7.88	5.74	2.25	61	2-61-06201-60-1	18.00
6	2.00	Mold On Rubber	850	7.88	5.74	2.25	61	2-61-06201-70-1	12.50
8	2.00	Cast Iron	3,000	10.13	6.67	2.25	61	2-61-08201-10-1	26.00
8	2.00	Phenolic Resin	2,800	10.13	6.67	2.25	61	2-61-08201-30-1	18.00
8	2.00	Standard Polyurethane	3,100	10.13	6.67	2.25	61	2-61-08201-60-1	25.00
8	2.00	Mold On Rubber	1,000	10.13	6.67	2.25	61	2-61-08201-70-1	35.00

Capacity listed is for manual operation. For powered operations, consult factory.

Part Numbers listed are for the swivel casters. For rigid casters, change the last digit from 1 to 2 (i.e. 96-10509-65-2)

See series codes for top plate and bolt hole dimensions.

All dimensions are in inches. All weights are in pounds.

CONTINUED

CASTERS DUAL WHEEL

STRAIGHT ROLLER BEARING (KINGPINLESS)

Diameter	Width	Material	Capacity	OAH	Swivel Radius	Swivel Lead	Series	Part Number	Weight
6	3.00	Mold On Rubber	1,400	8.00	6.29	2.25	71	2-71-06301-70-1	37.00
6	3.00	Standard Polyurethane	4,100	8.00	6.29	2.25	71	2-71-06301-60-1	40.00
6	3.00	Phenolic Resin	4,000	8.00	6.29	2.25	71	2-71-06301-30-1	26.00
6	3.00	Cast Iron	4,500	8.00	6.29	2.25	71	2-71-06301-10-1	37.00
8	3.00	Mold On Rubber	1,700	10.50	7.36	2.50	71	2-71-08301-70-1	38.00
8	3.00	Standard Polyurethane	4,500	10.50	7.36	2.50	71	2-71-08301-60-1	40.00
8	3.00	Phenolic Resin	4,500	10.50	7.36	2.50	71	2-71-08301-30-1	30.00
10	3.00	Mold On Rubber	2,000	12.50	8.26	2.50	71	2-71-10301-70-1	42.00
10	3.00	Standard Polyurethane	4,500	12.50	8.26	2.50	71	2-71-10301-60-1	52.00
10	3.00	Phenolic Resin	4,500	12.50	8.26	2.50	71	2-71-10301-30-1	35.00
12	3.00	Mold On Rubber	2,250	14.00	9.18	2.50	71	2-71-12301-70-1	51.00
12	3.00	Standard Polyurethane	4,500	14.00	9.18	2.50	71	2-71-12301-60-1	58.00
12	3.00	Phenolic Resin	4,500	14.00	9.18	2.50	71	2-71-12301-30-1	43.00
6	3.00	Standard Polyurethane	4,100	9.00	6.53	2.50	81	2-81-06301-60-1	44.00
6	3.00	Phenolic Resin	4,000	9.00	6.53	2.50	81	2-81-06301-30-1	39.00
6	3.00	Forged Steel	10,000	9.00	6.53	2.50	81	2-81-06301-20-1	65.00
8	3.00	Standard Polyurethane	5,000	11.00	7.39	2.50	81	2-81-08301-60-1	50.00
8	3.00	Phenolic Resin	5,000	11.00	7.39	2.50	81	2-81-08301-30-1	40.00
8	3.00	Forged Steel	9,000	11.00	7.39	2.50	81	2-81-08301-20-1	62.00
8	3.00	Cast Iron	7,000	11.00	7.39	2.50	81	2-81-08301-10-1	62.00
10	3.00	Standard Polyurethane	6,000	13.00	8.28	2.50	81	2-81-10301-60-1	58.00
10	3.00	Phenolic Resin	5,800	13.00	8.28	2.50	81	2-81-10301-30-1	45.00
10	3.00	H.D. Forged Steel	10,000	13.00	8.28	2.50	81	2-81-10301-21-1	81.00
10	3.00	Cast Iron	7,000	13.00	8.28	2.50	81	2-81-10301-10-1	71.00
6	3.00	Forged Steel	12,000	9.50	6.53	2.50	91	2-91-06301-20-1	85.00
8	4.00	Standard Polyurethane	7,600	11.50	7.92	2.50	91	2-91-08401-60-1	75.00
10	3.00	H.D. Standard Polyurethane	7,400	13.50	8.28	2.50	91	2-91-10301-65-1	88.00
10	3.00	Laminated Phenolic	6,800	13.50	8.28	2.50	91	2-91-10301-35-1	67.00
10	3.00	H.D. Forged Steel	12,000	13.50	8.28	2.50	91	2-91-10301-21-1	123.00
10	4.00	H.D. Standard Polyurethane	10,000	13.50	8.76	2.50	91	2-91-10401-65-1	103.00
10	4.00	Standard Polyurethane	8,400	13.50	8.76	2.50	91	2-91-10401-60-1	90.00
10	5.00	H.D. Standard Polyurethane	12,000	13.75	9.31	2.50	91	2-91-10501-65-1	103.00
12	3.00	H.D. Standard Polyurethane	7,700	15.50	9.2	2.50	91	2-91-12301-65-1	108.00
12	3.50	Laminated Phenolic	8,500	15.50	9.51	2.50	91	2-91-12351-35-1	97.00
12	4.00	H.D. Standard Polyurethane	11,000	15.50	9.63	2.50	91	2-91-12401-65-1	120.00
12	4.00	H.D. Hard Polyurethane (70D)	13,000	15.50	10.14	2.50	91	2-91-12401-67-1	120.00
12	5.00	H.D. Standard Polyurethane	12,500	15.75	10.14	2.50	91	2-91-12501-65-1	150.00
12	5.00	H.D. Hard Polyurethane (70D)	15,000	15.75	10.14	2.50	91	2-91-12501-67-1	130.00

CONTINUED

CASTERS DUAL WHEEL

PRECISION TAPERED BEARING (KINGPIN)

Diameter	Width	Material	Capacity	OAH	Swivel Radius	Swivel Lead	Series	Part Number	Weight
6	2.50	Mold On Rubber	1,080	8.00	6.16	2.25	70	72-06259-70-1	37.00
6	2.50	Standard Polyurethane	3,500	8.00	6.16	2.25	70	72-06259-60-1	40.00
6	2.50	Phenolic Resin	3,500	8.00	6.16	2.25	70	72-06259-30-1	26.00
6	2.50	Cast Iron	3,500	8.00	6.16	2.25	70	72-06259-10-1	37.00
8	2.50	Mold On Rubber	1,340	10.50	7.25	2.50	70	72-08259-70-1	38.00
8	2.50	Standard Polyurethane	3,500	10.50	7.25	2.50	70	72-08259-60-1	40.00
8	2.50	Phenolic Resin	3,500	10.50	7.25	2.50	70	72-08259-30-1	30.00
10	2.50	Mold On Rubber	1,550	12.50	8.16	2.50	70	72-10259-70-1	42.00
10	2.50	Standard Polyurethane	3,500	12.50	8.16	2.50	70	72-10259-60-1	52.00
10	2.50	Phenolic Resin	3,500	12.50	8.16	2.50	70	72-10259-30-1	35.00
12	2.50	Mold On Rubber	1,800	14.00	9.09	2.50	70	72-12259-70-1	51.00
12	2.50	Standard Polyurethane	3,500	14.00	9.09	2.50	70	72-12259-60-1	58.00
12	2.50	Phenolic Resin	3,500	14.00	9.09	2.50	70	72-12259-30-1	43.00
6	3.00	Standard Polyurethane	4,100	9.00	6.54	2.50	80	82-06309-60-1	44.00
6	3.00	Phenolic Resin	4,000	9.00	6.54	2.50	80	82-06309-30-1	39.00
6	3.00	Forged Steel	5,000	9.00	6.54	2.50	80	82-06309-20-1	65.00
8	3.00	Standard Polyurethane	5,000	11.00	7.40	2.50	80	82-08309-60-1	50.00
8	3.00	Phenolic Resin	5,000	11.00	7.40	2.50	80	82-08309-30-1	40.00
8	3.00	Forged Steel	5,000	11.00	7.40	2.50	80	82-08309-20-1	62.00
8	3.00	Cast Iron	5,000	11.00	7.40	2.50	80	82-08309-10-1	62.00
10	3.00	Standard Polyurethane	6,000	13.00	8.29	2.50	85	86-10309-60-1	58.00
10	3.00	Phenolic Resin	5,800	13.00	8.29	2.50	85	86-10309-30-1	45.00
10	3.00	H.D. Forged Steel	10,000	13.00	8.29	2.50	85	86-10309-21-1	81.00
10	3.00	Cast Iron	6,000	13.00	8.29	2.50	85	86-10309-10-1	71.00

Capacity listed is for manual operation. For powered operations, consult factory.

Part Numbers listed are for the swivel casters. For rigid casters, change the last digit from 1 to 2 (i.e. 96-10509-65-2)

See series codes for top plate and bolt hole dimensions.

All dimensions are in inches. All weights are in pounds.

CONTINUED

CASTERS DUAL WHEEL

PRECISION TAPERED BEARING (KINGPIN)

Diameter	Width	Material	Capacity	OAH	Swivel Radius	Swivel Lead	Series	Part Number	Weight
6	3.00	Forged Steel	17,000	9.00	6.54	2.50	95	96-06309-20-1	85.00
6	5.00	H.D. Standard Polyurethane	7,400	9.00	7.80	2.50	95	96-06509-65-1	90.00
8	3.00	H.D. Standard Polyurethane	6,200	11.00	7.40	2.50	95	96-08309-65-1	75.00
8	4.00	Standard Polyurethane	7,600	11.00	7.92	2.50	95	96-08409-60-1	75.00
8	4.00	H.D. Forged Steel	17,000	11.00	7.92	2.50	95	96-08409-21-1	112.00
10	3.00	H.D. Standard Polyurethane	7,400	13.00	8.29	2.50	95	96-10309-65-1	88.00
10	3.00	Laminated Phenolic	6,000	13.00	8.29	2.50	95	96-10309-35-1	67.00
10	3.00	H.D. Forged Steel	13,000	13.00	8.29	2.50	95	96-10309-21-1	123.00
10	4.00	H.D. Forged Steel	17,000	13.00	8.76	2.50	95	96-10409-21-1	140.00
10	4.00	H.D. Standard Polyurethane	10,000	13.00	8.76	2.50	95	96-10409-65-1	103.00
10	4.00	Standard Polyurethane	8,400	13.00	8.76	2.50	95	96-10409-60-1	90.00
10	5.00	H.D. Standard Polyurethane	12,000	13.00	9.32	2.50	95	96-10509-65-1	103.00
12	3.00	H.D. Standard Polyurethane	7,700	15.50	9.20	2.50	95	96-12309-65-1	108.00
12	3.50	Laminated Phenolic	8,500	15.50	9.52	2.50	95	96-12359-35-1	97.00
12	4.00	H.D. Standard Polyurethane	11,000	15.50	9.52	2.50	95	96-12409-65-1	120.00
12	4.00	H.D. Hard Polyurethane (70D)	13,000	15.50	9.52	2.50	95	96-12409-67-1	100.00
12	5.00	H.D. Standard Polyurethane	12,500	15.50	10.14	2.50	95	96-12509-65-1	150.00
12	5.00	H.D. Hard Polyurethane (70D)	15,000	15.50	10.14	2.50	95	96-12509-67-1	130.00
16	5.00	H.D. Standard Polyurethane	16,000	19.00	13.21	4.00	95	96-16509-65-1	200.00
16	5.00	H.D. Hard Polyurethane (70D)	16,000	19.00	13.21	4.00	95	96-16509-67-1	200.00
18	5.00	H.D. Standard Polyurethane	17,000	23.00	14.13	4.00	95	96-18509-65-1	220.00
18	5.00	H.D. Hard Polyurethane (70D)	17,000	23.00	14.13	4.00	95	96-18509-67-1	220.00

PRECISION TAPERED BEARING (KINGPIN)

Diameter	Width	Material	Capacity	OAH	Swivel Radius	Swivel Lead	Series	Part Number	Weight
6	3.00	Forged Steel	10,000	9.50	6.33	2.25	97	2-97-06309-20-1	
6	3.00	H.D. Forged Steel	10,000	9.50	6.33	2.25	97	2-97-06309-21-1	
6	4.00	H.D. Standard Polyurethane	6,000	9.50	6.94	2.25	97	2-97-06409-65-1	
6	4.00	HPPT Polyurethane	9,200	9.50	6.94	2.25	97	2-97-06409-95-1	
6	4.00	H.D. T/R-95 Polyurethane	8,280	9.50	6.94	2.25	97	2-97-06409-96-1	
8	4.00	Forged Steel	10,000	11.50	7.72	2.25	97	2-97-08409-20-1	
8	4.00	H.D. Forged Steel	10,000	11.50	7.72	2.25	97	2-97-08409-21-1	
8	4.00	Standard Polyurethane	7,600	11.50	7.72	2.25	97	2-97-08409-60-1	
10	3.00	Laminated Phenolic	6,800	13.50	8.29	2.50	97	2-97-10309-35-1	
10	3.00	H.D. Forged Steel	10,000	13.50	8.29	2.50	97	2-97-10309-21-1	
10	3.00	H.D. Standard Polyurethane	7,400	13.50	8.29	2.50	97	2-97-10309-65-1	
10	3.00	H.D. T/R-95 Polyurethane	8,700	13.50	8.29	2.50	97	2-97-10309-96-1	
10	4.00	Forged Steel	10,000	13.50	8.76	2.50	97	2-97-10409-20-1	
10	4.00	H.D. Forged Steel	10,000	13.50	8.76	2.50	97	2-97-10409-21-1	
10	4.00	Standard Polyurethane	8,400	13.50	8.76	2.50	97	2-97-10409-60-1	

CONTINUED

CASTERS DUAL WHEEL

PRECISION TAPERED BEARING (KINGPIN)

Diameter	Width	Material	Capacity	OAH	Swivel Radius	Swivel Lead	Series	Part Number	Weight
10	4.00	H.D. Standard Polyurethane	10,000	13.50	8.76	2.50	97	2-97-10409-65-1	
10	4.00	HPPT Polyurethane	10,000	13.50	8.76	2.50	97	2-97-10409-95-1	
10	4.00	H.D. T/R-95 Polyurethane	10,000	13.50	8.76	2.50	97	2-97-10409-96-1	
10	5.00	H.D. Standard Polyurethane	10,000	13.75	9.32	2.50	97	2-97-10509-65-1	
10	5.00	HPPT Polyurethane	10,000	13.75	9.32	2.50	97	2-97-10509-95-1	
10	5.00	H.D. T/R-95 Polyurethane	10,000	13.50	9.32	2.50	97	2-97-10509-96-1	
12	4.00	Ductile Iron	10,000	15.50	9.63	2.50	97	2-97-12409-12-1	
12	4.00	H.D. Standard Polyurethane	10,000	15.50	9.63	2.50	97	2-97-12409-65-1	
12	4.00	HPPT Polyurethane	10,000	15.50	9.63	2.50	97	2-97-12409-95-1	
12	4.00	H.D. T/R-95 Polyurethane	10,000	15.50	9.63	2.50	97	2-97-12409-96-1	
12	5.00	Ductile Iron	10,000	15.75	10.14	2.50	97	2-97-12509-12-1	
12	5.00	H.D. Standard Polyurethane	10,000	15.75	10.14	2.50	97	2-97-12509-65-1	
12	5.00	HPPT Polyurethane	10,000	15.75	10.14	2.50	97	2-97-12509-95-1	
12	5.00	H.D. T/R-95 Polyurethane	10,000	15.75	10.14	2.50	97	2-97-12509-96-1	
16	5.00	H.D. Standard Polyurethane	10,000	19.75	12.31	3.00	97	2-97-16509-65-1	
16	5.00	HPPT Polyurethane	10,000	19.75	12.31	3.00	97	2-97-16509-95-1	
16	5.00	H.D. T/R-95 Polyurethane	10,000	19.75	12.31	3.00	97	2-97-16509-96-1	
18	5.00	H.D. Standard Polyurethane	10,000	21.75	14.13	4.00	97	2-97-18509-65-1	
18	5.00	HPPT Polyurethane	10,000	21.75	14.13	4.00	97	2-97-18509-95-1	
18	5.00	H.D. T/R-95 Polyurethane	10,000	21.75	14.13	4.00	97	2-97-18509-96-1	
20	5.00	H.D. Standard Polyurethane	10,000	23.75	15.05	4.00	97	2-97-20509-65-1	
20	5.00	HPPT Polyurethane	10,000	23.75	15.05	4.00	97	2-97-20509-95-1	
20	5.00	H.D. T/R-95 Polyurethane	10,000	23.75	15.05	4.00	97	2-97-20509-96-1	

PRECISION TAPERED BEARING (KINGPIN)

Diameter	Width	Material	Capacity	OAH	Swivel Radius	Swivel Lead	Series	Part Number	Weight
6	3.00	Forged Steel	12,000	10.75	6.33	2.25	97	2-97HD-06309-20-1	
6	3.00	H.D. Forged Steel	20,000	10.75	6.33	2.25	97	2-97HD-06309-21-1	
6	4.00	H.D. Standard Polyurethane	6,000	10.75	6.94	2.25	97	2-97HD-06409-65-1	
6	4.00	HPPT Polyurethane	9,200	10.75	6.94	2.25	97	2-97HD-06409-95-1	
6	4.00	H.D. T/R-95 Polyurethane	8,280	10.75	6.94	2.25	97	2-97HD-06409-96-1	
8	4.00	Forged Steel	16,800	12.75	7.72	2.25	97	2-97HD-08409-20-1	
8	4.00	H.D. Forged Steel	20,000	12.75	7.72	2.25	97	2-97HD-08409-21-1	
8	4.00	Standard Polyurethane	7,600	12.75	7.72	2.25	97	2-97HD-08409-60-1	
10	3.00	Laminated Phenolic	6,800	14.50	8.29	2.50	97	2-97HD-10309-35-1	
10	3.00	H.D. Forged Steel	13,000	14.50	8.29	2.50	97	2-97HD-10309-21-1	
10	3.00	H.D. Standard Polyurethane	7,400	14.50	8.29	2.50	97	2-97HD-10309-65-1	
10	3.00	H.D. T/R-95 Polyurethane	8,700	14.50	8.29	2.50	97	2-97HD-10309-96-1	
10	4.00	Forged Steel	16,800	14.50	8.76	2.50	97	2-97HD-10409-20-1	
10	4.00	H.D. Forged Steel	20,000	14.50	8.76	2.50	97	2-97HD-10409-21-1	

Capacity listed is for manual operation. For powered operations, consult factory.

Part Numbers listed are for the swivel casters. For rigid casters, change the last digit from 1 to 2 (i.e. 96-10509-65-2)

See series codes for top plate and bolt hole dimensions.

All dimensions are in inches. All weights are in pounds.

CONTINUED

CASTERS DUAL WHEEL

PRECISION TAPERED BEARING (KINGPIN)

Diameter	Width	Material	Capacity	OAH	Swivel Radius	Swivel Lead	Series	Part Number	Weight
10	4.00	Standard Polyurethane	8,400	14.50	8.76	2.50	97	2-97HD-10409-60-1	
10	4.00	H.D. Standard Polyurethane	10,000	14.50	8.76	2.50	97	2-97HD-10409-65-1	
10	4.00	HPPT Polyurethane	13,000	14.50	8.76	2.50	97	2-97HD-10409-95-1	
10	4.00	H.D. T/R-95 Polyurethane	11,700	14.50	8.76	2.50	97	2-97HD-10409-96-1	
10	5.00	H.D. Standard Polyurethane	12,000	14.50	9.32	2.50	97	2-97HD-10509-65-1	
10	5.00	HPPT Polyurethane	15,800	14.50	9.32	2.50	97	2-97HD-10509-95-1	
10	5.00	H.D. T/R-95 Polyurethane	14,200	14.50	9.32	2.50	97	2-97HD-10509-96-1	
12	4.00	Ductile Iron	15,000	16.75	9.63	2.50	97	2-97HD-12409-12-1	
12	4.00	H.D. Standard Polyurethane	11,000	16.75	9.63	2.50	97	2-97HD-12409-65-1	
12	4.00	HPPT Polyurethane	14,000	16.75	9.63	2.50	97	2-97HD-12409-95-1	
12	4.00	H.D. T/R-95 Polyurethane	12,600	16.75	9.63	2.50	97	2-97HD-12409-96-1	
12	5.00	Ductile Iron	20,000	16.75	10.14	2.50	97	2-97HD-12509-12-1	
12	5.00	H.D. Standard Polyurethane	13,000	16.75	10.14	2.50	97	2-97HD-12509-65-1	
12	5.00	HPPT Polyurethane	16,800	16.75	10.14	2.50	97	2-97HD-12509-95-1	
12	5.00	H.D. T/R-95 Polyurethane	15,120	16.75	10.14	2.50	97	2-97HD-12509-96-1	
16	4.00	H.D. Standard Polyurethane	12,000	20.75	11.90	3.00	97	2-97HD-16409-65-1	
16	4.00	HPPT Polyurethane	16,250	20.75	11.90	3.00	97	2-97HD-16409-95-1	
16	4.00	H.D. T/R-95 Polyurethane	14,600	20.75	11.90	3.00	97	2-97HD-16409-96-1	
16	5.00	H.D. Standard Polyurethane	16,000	20.75	12.31	3.00	97	2-97HD-16509-65-1	
16	5.00	HPPT Polyurethane	18,250	20.75	12.31	3.00	97	2-97HD-16509-95-1	
16	5.00	H.D. T/R-95 Polyurethane	16,400	20.75	12.31	3.00	97	2-97HD-16509-96-1	
18	5.00	H.D. Standard Polyurethane	17,000	22.75	14.13	4.00	97	2-97HD-18509-65-1	
18	5.00	HPPT Polyurethane	19,000	22.75	14.13	4.00	97	2-97HD-18509-95-1	
18	5.00	H.D. T/R-95 Polyurethane	17,100	22.75	14.13	4.00	97	2-97HD-18509-96-1	
20	5.00	H.D. Standard Polyurethane	18,000	24.75	15.05	4.00	97	2-97HD-20509-65-1	
20	5.00	HPPT Polyurethane	20,000	24.75	15.05	4.00	97	2-97HD-20509-95-1	
20	5.00	H.D. T/R-95 Polyurethane	20,000	24.75	15.05	4.00	97	2-97HD-20509-96-1	

PRECISION TAPERED BEARING (KINGPIN)

Diameter	Width	Material	Capacity	OAH	Swivel Radius	Swivel Lead	Series	Part Number	Weight
18	7.00	H.D. Forged Steel	50,000	24.00	16.56	5.50	99	2-99HD-18709-20-1	
22	12.00	H.D. Hard Polyurethane (70D)	35,000	28.00	21.02	5.50	99	2-99HD-22129-96-1	
28	16.00	H.D. Soft Polyurethane	50,000	34.00	25.56	5.50	99	2-99HD-28169-69-1	1,675.00

PRECISION TAPERED BEARING (KINGPINLESS)

Diameter	Width	Material	Capacity	OAH	Swivel Radius	Swivel Lead	Series	Part Number	Weight
6	3.00	Mold On Rubber	1,400	8.00	6.29	2.25	71	2-71-06309-70-1	37.00
6	3.00	Standard Polyurethane	4,100	8.00	6.29	2.25	71	2-71-06309-60-1	40.00
6	3.00	Cast Iron	4,500	8.00	6.29	2.25	71	2-71-06309-10-1	37.00

CONTINUED

CASTERS DUAL WHEEL

PRECISION TAPERED BEARING (KINGPINLESS)

Diameter	Width	Material	Capacity	OAH	Swivel Radius	Swivel Lead	Series	Part Number	Weight
8	3.00	Mold On Rubber	1,700	10.50	7.36	2.50	71	2-71-08309-70-1	38.00
8	3.00	Standard Polyurethane	4,500	10.50	7.36	2.50	71	2-71-08309-60-1	40.00
10	3.00	Mold On Rubber	2,000	12.50	8.26	2.50	71	2-71-10309-70-1	42.00
10	3.00	Standard Polyurethane	4,500	12.50	8.26	2.50	71	2-71-10309-60-1	52.00
10	3.00	Phenolic Resin	4,500	12.50	8.26	2.50	71	2-71-10309-30-1	35.00
12	3.00	Mold On Rubber	2,250	14.00	9.18	2.50	71	2-71-12309-70-1	51.00
12	3.00	Standard Polyurethane	4,500	14.00	9.18	2.50	71	2-71-12309-60-1	58.00
12	3.00	Phenolic Resin	4,500	14.00	9.18	2.50	71	2-71-12309-30-1	43.00

PRECISION TAPERED BEARING (KINGPINLESS)

Diameter	Width	Material	Capacity	OAH	Swivel Radius	Swivel Lead	Series	Part Number	Weight
6	3.00	Standard Polyurethane	4,100	9.00	6.53	2.50	81	2-81-06309-60-1	44.00
6	3.00	Phenolic Resin	4,000	9.00	6.53	2.50	81	2-81-06309-30-1	39.00
6	3.00	Forged Steel	10,000	9.00	6.53	2.50	81	2-81-06309-20-1	65.00
8	3.00	Standard Polyurethane	5,000	11.00	7.39	2.50	81	2-81-08309-60-1	50.00
8	3.00	Phenolic Resin	5,000	11.00	7.39	2.50	81	2-81-08309-30-1	40.00
8	3.00	Forged Steel	9,000	11.00	7.39	2.50	81	2-81-08309-20-1	62.00
8	3.00	Cast Iron	7,000	11.00	7.39	2.50	81	2-81-08309-10-1	62.00
10	3.00	Standard Polyurethane	6,000	13.00	8.28	2.50	81	2-81-10309-60-1	58.00
10	3.00	Phenolic Resin	5,800	13.00	8.28	2.50	81	2-81-10309-30-1	45.00
10	3.00	H.D. Forged Steel	10,000	13.00	8.28	2.50	81	2-81-10309-21-1	81.00
10	3.00	Cast Iron	7,000	13.00	8.28	2.50	81	2-81-10309-10-1	71.00
6	3.00	Forged Steel	12,000	9.50	6.53	2.50	91	2-91-06309-20-1	85.00
6	5.00	H.D. Standard Polyurethane	7,400	9.75	7.8	2.50	91	2-91-06509-65-1	90.00
8	3.00	H.D. Standard Polyurethane	6,200	11.50	7.39	2.50	91	2-91-08309-65-1	75.00
8	4.00	Standard Polyurethane	7,600	11.50	7.92	2.50	91	2-91-08409-60-1	75.00
8	4.00	H.D. Forged Steel	20,000	11.50	7.92	2.50	91	2-91-08409-21-1	112.00
10	3.00	H.D. Standard Polyurethane	7,400	13.50	8.28	2.50	91	2-91-10309-65-1	88.00
10	3.00	Laminated Phenolic	6,800	13.50	8.28	2.50	91	2-91-10309-35-1	67.00
10	3.00	H.D. Forged Steel	12,000	13.50	8.28	2.50	91	2-91-10309-21-1	123.00
10	4.00	H.D. Forged Steel	20,000	13.50	8.76	2.50	91	2-91-10409-21-1	140.00
10	4.00	H.D. Standard Polyurethane	10,000	13.50	8.76	2.50	91	2-91-10409-65-1	103.00
10	4.00	Standard Polyurethane	8,400	13.50	8.76	2.50	91	2-91-10409-60-1	90.00
10	5.00	H.D. Standard Polyurethane	12,000	13.75	9.31	2.50	91	2-91-10509-65-1	103.00
12	3.00	H.D. Standard Polyurethane	7,700	15.50	9.2	2.50	91	2-91-12309-65-1	108.00
12	3.50	Laminated Phenolic	8,500	15.50	9.51	2.50	91	2-91-12359-35-1	97.00
12	4.00	H.D. Standard Polyurethane	11,000	15.50	9.63	2.50	91	2-91-12409-65-1	120.00
12	4.00	H.D. Hard Polyurethane (70D)	13,000	15.50	10.14	2.50	91	2-91-12409-67-1	120.00
12	5.00	H.D. Standard Polyurethane	12,500	15.75	10.14	2.50	91	2-91-12509-65-1	150.00

Capacity listed is for manual operation. For powered operations, consult factory.

Part Numbers listed are for the swivel casters. For rigid casters, change the last digit from 1 to 2 (i.e. 96-10509-65-2)

See series codes for top plate and bolt hole dimensions.

All dimensions are in inches. All weights are in pounds.

CONTINUED

CASTERS DUAL WHEEL

PRECISION TAPERED BEARING (KINGPINLESS)

Diameter	Width	Material	Capacity	OAH	Swivel Radius	Swivel Lead	Series	Part Number	Weight
12	5.00	H.D. Hard Polyurethane (70D)	15,000	15.75	10.14	2.50	91	2-91-12509-67-1	130.00
16	5.00	H.D. Standard Polyurethane	16,000	19.75	13.21	4.00	91	2-91-16509-65-1	200.00
16	5.00	H.D. Hard Polyurethane (70D)	18,000	19.75	13.21	4.00	91	2-91-16509-67-1	200.00
18	5.00	H.D. Standard Polyurethane	17,000	21.75	14.12	4.00	91	2-91-18509-65-1	220.00
18	5.00	H.D. Hard Polyurethane (70D)	18,000	21.75	14.12	4.00	91	2-91-18509-67-1	220.00
20	5.00	H.D. Standard Polyurethane	18,000	23.75	15.05	4.00	91	2-91-20509-65-1	240.00
20	5.00	H.D. Hard Polyurethane (70D)	20,000	23.75	15.05	4.00	91	2-91-20509-67-1	240.00

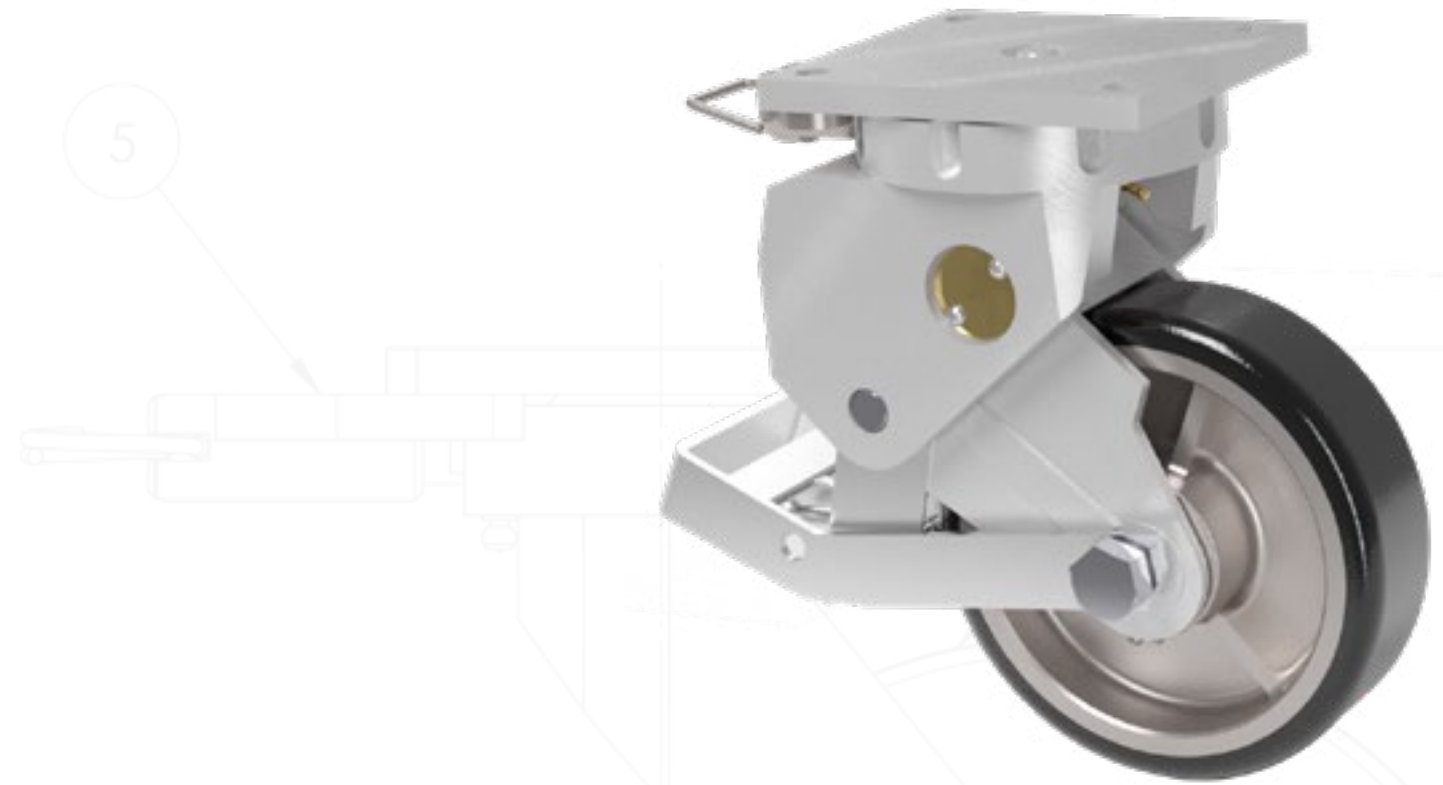

ALUMINUM CASTERS
MODERN SUSPENSION

ALUMINUM CASTERS MODERN SUSPENSION



MAXIMUM CAPACITY

25,000 lbs.

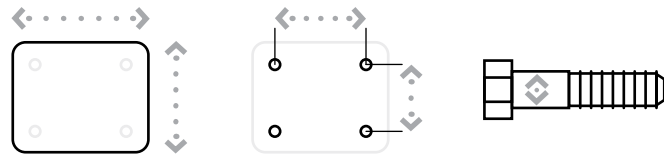

Top Plate Size	Bolt Hole Spacing	Bolt Diameter
25 Series Standard: 3.75" x 2.75"	3" x 1.75"	0.312"
33 Series Standard: 4.5" x 3.75"	3.625" x 2.625"	0.375"
38 Series Standard: 6.75" x 6"	5.50" x 4.625"	0.5"
38-3 Series Standard: 6.75" x 6"	5.50" x 4.625"	0.5"
39 Series Standard: 6.75" x 6"	5.50" x 4.625"	0.5"
40 Series Standard: 11" x 9"	9.75" x 7"	0.625"
40H Series Standard: 11" x 9"	9.75" x 7"	0.625"
138 Series Standard: 11" x 9"	9.75" x 7"	0.625"
140 Series Standard: 11" x 9"	9.75" x 7"	0.625"

FEATURES

Swivel Section: Aluminum constructed, including the yoke, swivel section, and wheel core. Steel constructed casters available.

Axle: 5/16" - 3/4" diameter axles.

Lubrication: Pre-lubricated before shipping.

Wheels: 3" to 16" diameter wheels. Single and dual wheel options available.

APPLICATIONS

Aviation Equipment / Ground Support
Aerospace Manufacturing / Aircraft Dollies
Airline Catering / Food Service
Assembly Fixtures / Automotive
Cargo Decks / Pallet Trailers
Defense / Military Equipment
Electronics / Office Equipment
Luggage Racks / Hotel Equipment
Race Car Pit Carts / Tooling Fixtures
Staging / Mobile Movie Sets

BENEFITS

Our Modern Suspension® casters utilize our Vari-Flex linear suspension system, which achieves optimal shock reduction, and drastically reduces shimmy, dynamic bounce and resonance when the cart is empty, or loaded beyond its rated capacity.

In addition, our dual wheel models feature a completely independent suspension. Each wheel is on its own separate axle with separate legs. This helps to keep both wheels on the ground and help keep the load level, even when the ground isn't.

TOP PLATES CONTINUED

Top Plate Size	Bolt Hole Spacing	Bolt Diameter
339 Series Standard: 11" x 9"	9.75" x 7"	0.625"
340 Series Standard: 11" x 9"	9.75" x 7"	0.625"
440 Series Standard: 12" x 12"	8.50" x 8.50"	0.75"
539 Series Standard: 12" x 12"	8.50" x 8.50"	0.75"
539H Series Standard: 12" x 12"	8.50" x 8.50"	0.75"

ALUMINUM CASTERS MODERN SUSPENSION

25 SERIES ALUMINUM CASTERS

Diameter	Width	Material	Capacity Range	Non-Flexed Height	Full-Flexed Height	Swivel Radius	Series	Weight
3	1.38	Thermoplastic	160-442	5.5	4.75	3.19	25	4.75
6	1.25	Mold On Rubber	100-276	8.31	7.31	6.25	25	5
6	1.38	Standard Polyurethane	100-276	8.31	7.31	6.25	25	5

33 SERIES ALUMINUM CASTERS

Diameter	Width	Material	Capacity Range	Non-Flexed Height	Full-Flexed Height	Swivel Radius	Series	Weight
4	2.00	Phenolic Resin	210-625	7.31	5.94	3.88	33	5.75
4	2.00	Standard Polyurethane	210-625	7.31	5.94	3.88	33	5.75
6	2.00	Phenolic Resin	135-540	9.13	7.63	5.50	33	6.75
6	2.00	Standard Polyurethane	135-540	9.13	7.63	5.50	33	6.75
8	2.00	Standard Polyurethane	90-360	11.38	9.63	7.38	33	10.75

38 SERIES ALUMINUM CASTERS

Diameter	Width	Material	Capacity Range	Non-Flexed Height	Full-Flexed Height	Swivel Radius	Series	Weight
6	2.00	Standard Polyurethane	490-995	9.88	8.38	5.38	38	18.00
8	2.50	Mold On Rubber	470-955	11.88	10.38	6.63	38	21.00
8	2.50	Phenolic Resin	470-955	11.88	10.38	6.63	38	21.00
8	2.50	Standard Polyurethane	470-955	11.88	10.38	6.63	38	21.00

39 SERIES ALUMINUM CASTERS

Diameter	Width	Material	Capacity Range	Non-Flexed Height	Full-Flexed Height	Swivel Radius	Series	Weight
8	2.50	Mold On Rubber	425-3,600	11.75	10.25	8.13	39	38.00
8	3.00	Standard Polyurethane	425-3,600	11.75	10.25	8.13	39	38.00
10	3.00	Mold On Rubber	400-3,000	14.38	12.38	9.38	39	41.00
10	3.00	Standard Polyurethane	400-3,000	14.38	12.38	9.38	39	41.00
10	3.00	Phenolic Resin	400-3,000	14.38	12.38	9.38	39	41.00
12	3.00	Standard Polyurethane	350-3,150	17.00	15.00	10.63	39	44.00

138 SERIES ALUMINUM CASTERS

Diameter	Width	Material	Capacity Range	Non-Flexed Height	Full-Flexed Height	Swivel Radius	Series	Weight
10	4.00	Mold On Rubber	1,600-4,750	15.75	13.25	10.00	138	90.00
10	4.00	Standard Polyurethane	1,600-4,750	15.75	13.25	10.00	138	90.00

339 SERIES ALUMINUM CASTERS

Diameter	Width	Material	Capacity Range	Non-Flexed Height	Full-Flexed Height	Swivel Radius	Series	Weight
16	5.00	Mold On Rubber	3,740-7,824	21.88	19.13	15.00	339	185.00
16	5.00	Standard Polyurethane	3,740-7,824	21.88	19.13	15.00	339	185.00

Capacity listed is for manual operation. For powered operations, consult factory.
Part numbers listed are for the swivel casters. For rigid casters, please consult factory.
All dimensions are in inches. All weights are in pounds.
Swivel radius is for unloaded caster.

CONTINUED

STEEL CASTERS MODERN SUSPENSION

33 SERIES STEEL CASTERS

Diameter	Width	Material	Capacity Range	Non-Flexed Height	Full-Flexed Height	Swivel Radius	Series	Weight
4	2.00	Phenolic Resin	200-675	7.31	6.31	3.88	33	14.50
4	2.00	Standard Polyurethane	200-675	7.31	6.31	3.88	33	14.50
6	2.00	Phenolic Resin	135-625	9.25	8.13	5.50	33	16.50
6	2.00	Standard Polyurethane	135-625	9.25	8.13	5.50	33	16.50
8	2.00	Standard Polyurethane	135-460	11.63	10.38	7.38	33	20.00

38 SERIES STEEL CASTERS

Diameter	Width	Material	Capacity Range	Non-Flexed Height	Full-Flexed Height	Swivel Radius	Series	Weight
6	2.00	Standard Polyurethane	640-900	9.69	8.31	5.38	38	28.00
8	2.50	Mold On Rubber	440-1,200	11.94	10.44	6.63	38	31.00
8	2.50	Phenolic Resin	440-1,200	11.94	10.44	6.63	38	31.00
8	2.50	Standard Polyurethane	440-1,200	11.94	10.44	6.63	38	31.00
10			425-800	13.75	12.13	8.38	38	35.00

38-3 SERIES STEEL CASTERS

Diameter	Width	Material	Capacity Range	Non-Flexed Height	Full-Flexed Height	Swivel Radius	Series	Weight
6	3.00	Standard Polyurethane	885-1,400	9.69	8.31	5.38	38-3	30.00
8	2.50	Phenolic Resin	660-1,800	11.94	10.44	6.63	38-3	32.00
8	2.50	Standard Polyurethane	660-1,800	11.94	10.44	6.63	38-3	32.00
8	3.00	Standard Polyurethane	660-1,800	11.94	10.44	6.63	38-3	32.00
10	3.00	Standard Polyurethane	650-1,160	13.75	12.13	8.38	38-3	36.00

39 SERIES STEEL CASTERS

Diameter	Width	Material	Capacity Range	Non-Flexed Height	Full-Flexed Height	Swivel Radius	Series	Weight
8	2.50	Mold On Rubber	375-3,570	11.81	10.31	8.13	39	51.00
8	3.00	Standard Polyurethane	375-3,570	14.38	10.31	8.13	39	51.00
10	3.00	Mold On Rubber	390-3,212	14.38	12.50	9.38	39	54.00
10	3.00	Standard Polyurethane	390-3,212	14.38	12.50	9.38	39	54.00
10	3.00	Phenolic Resin	390-3,212	14.38	12.50	9.38	39	54.00
12	3.00	Standard Polyurethane	320-3,100	17.06	15.06	10.63	39	65.00
16	3.00	Standard Polyurethane	1,665-2,954	20.13	16.50	14.63	39	93.00

CONTINUED

STEEL CASTERS MODERN SUSPENSION

40 SERIES STEEL CASTERS

Diameter	Width	Material	Capacity Range	Non-Flexed Height	Full-Flexed Height	Swivel Radius	Series	Weight
10	5.00	ErgoTread	2,471-4,750	15.56	13.69	9.75	40	110.00
10	5.00	Standard Polyurethane	2,471-4,750	15.56	13.69	9.75	40	110.00
10	5.00	Standard Polyurethane	2,471-4,750	15.56	13.69	9.75	40	110.00
15	5.00	Standard Polyurethane		20.25	17.94	14.25	40	134.00
16	5.00	Mold On Rubber					40	
16	5.00	Standard Polyurethane					40	

40H SERIES STEEL CASTERS

Diameter	Width	Material	Capacity Range	Non-Flexed Height	Full-Flexed Height	Swivel Radius	Series	Weight
10	5.00	ErgoTread	4,988	16.31	14.44	9.75	40H	125.00
10	5.00	Standard Polyurethane	4,988	16.31	14.44	9.75	40H	125.00
10	5.00	Standard Polyurethane	4,988	16.31	14.44	9.75	40H	125.00
15	5.00	Standard Polyurethane		20.56	18.06	14.25	40H	143.00

140 SERIES STEEL CASTERS

Diameter	Width	Material	Capacity Range	Non-Flexed Height	Full-Flexed Height	Swivel Radius	Series	Weight
8			680-6,650	12.25	10.50	9.13	140	119.00
10	3.00	Standard Polyurethane	812-6,424	14.50	12.63	10.63	140	128.00
12	6.00	Standard Polyurethane	670-6,400	17.31	15.44	12.00	140	144.00
16	3.00	Mold On Rubber	1,665	21.25	18.75	15.63	140	206.00
16	3.00	Standard Polyurethane	1,665	21.25	18.75	15.63	140	206.00

340 SERIES STEEL CASTERS

Diameter	Width	Material	Capacity Range	Non-Flexed Height	Full-Flexed Height	Swivel Radius	Series	Weight
10				16.38	14.44	12.25	340	202.00
16	5.00	Standard Polyurethane	1,665-7,088	21.13	18.44	16.50	340	240.00

440 SERIES STEEL CASTERS

Diameter	Width	Material	Capacity Range	Non-Flexed Height	Full-Flexed Height	Swivel Radius	Series	Weight
10	5.00	Standard Polyurethane	7,032-12,952	18.31	16.38	12.25	440	230.00
15	5.00	Standard Polyurethane	5,680-9,380	22.56	20.00	16.00	440	310.00

539 SERIES STEEL CASTERS

Diameter	Width	Material	Capacity Range	Non-Flexed Height	Full-Flexed Height	Swivel Radius	Series	Weight
15	5.00	Standard Polyurethane	16,000	25.94	22.94	16	539	630.00

539H SERIES STEEL CASTERS

Diameter	Width	Material	Capacity Range	Non-Flexed Height	Full-Flexed Height	Swivel Radius	Series	Weight
15	5.00	Standard Polyurethane	25,000	25.94	24.44	16	539H	730.00

Capacity listed is for manual operation. For powered operations, consult factory.
Part numbers listed are for the swivel casters. For rigid casters, please consult factory.
All dimensions are in inches. All weights are in pounds.
Swivel radius is for unloaded caster.

CASTERS SHOCK ABSORBING



FEATURES

Our popular shock absorbing casters have swivel sections that are constructed of high alloy steel and are precision machined for close tolerances and long life. These casters feature legs of thick section plate steel. Integrally forged kingpins are available from 3/4" to 1-1/4" in diameter. In normal configurations, these swivel sections will carry 3 to 4 times their listed capacity.

APPLICATIONS

Shock absorbing casters are ideal for jet engine dollies, aircraft jacks, in-plant trailers, trash gondolas, lift truck stabilizer casters, revolving signs and parade floats.

BENEFITS

The high strength chrome vanadium springs provide longer life through constant flexing and compressing. The spring compression starts with as little as 25 pounds loading per caster resulting in cushioned loads and quiet empty returns. The long swivel lead reduces excessive shimmy and vibration while towing.

OPTIONS

BRAKES

Poly Lock: P
Face Contact: F

SWIVEL LOCKS

Factory Installed: L
Demountable: DL
Foot Actuated: KL

MAXIMUM CAPACITY
20,000 lbs.

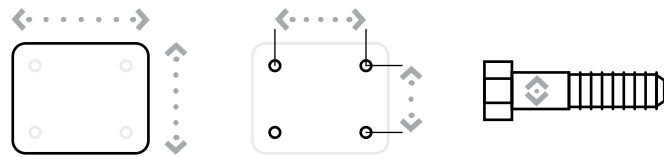

Top Plate Size	Bolt Hole Spacing	Bolt Diameter
Standard 53: 4" x 5"	2.625" x 3.625" Slotted to 3" x 3"	0.75"
Standard 63/67: 4.5" x 6.25"	2.438" x 4.938" Slotted to 3.375" x 5.25"	0.5"
Standard 73: 5" x 7.25"	3.375" x 5.25" Slotted to 4.125" x 6.125"	0.5"
Standard 83: 6" x 7.5"	4.5" x 6"	0.5"
Standard 93: 8.5" x 8.5"	7" x 7"	0.625"

CASTERS SHOCK ABSORBING

STRAIGHT ROLLER BEARING

Diameter	Width	Material	Capacity	OAH	Swivel Radius	Swivel Lead	Series	Part Number	Weight
6	3.00	Standard Polyurethane	1,100	10.00	7.16	4.00	71	73-06301-60-1	35.00
6	3.00	Mold On Rubber	700	10.00	7.16	4.00	71	73-06301-70-1	34.00
6	3.00	Phenolic Resin	1,100	10.00	7.16	4.00	71	73-06301-30-1	28.00
8	3.00	Standard Polyurethane	1,100	12.00	8.14	4.00	71	73-08301-60-1	38.00
8	3.00	Mold On Rubber	850	12.00	8.14	4.00	71	73-08301-70-1	38.00
8	3.00	H.D. T/R Polyurethane	1,100	12.00	8.14	4.00	71	73-08301-66-1	32.00
10	3.00	Standard Polyurethane	1,100	13.50	9.62	4.50	71	73-10301-60-1	45.00
10	3.00	Mold On Rubber	1,100	13.50	9.62	4.50	71	73-10301-70-1	42.00
10	3.00	H.D. T/R Polyurethane	1,100	13.50	9.62	4.50	71	73-10301-66-1	38.00
8	3.00	Standard Polyurethane	1,700	12.00	8.14	4.00	80	83-08301-60-1	58.00
8	3.00	Mold On Rubber	825	12.00	8.14	4.00	80	83-08301-70-1	58.00
8	3.00	H.D. T/R Polyurethane	1,700	12.00	8.14	4.00	80	83-08301-66-1	48.00
10	3.00	Standard Polyurethane	1,700	14.50	9.62	4.50	80	83-10301-60-1	65.00
10	3.00	Mold On Rubber	1,000	14.50	9.62	4.50	80	83-10301-70-1	55.00
10	3.00	H.D. T/R Polyurethane	1,700	14.50	9.62	4.50	80	83-10301-66-1	50.00
12	3.00	Standard Polyurethane	1,500	17.00	11.60	5.50	80	83-12301-60-1	65.00
12	3.00	Mold On Rubber	1,150	17.00	11.60	5.50	80	83-12301-70-1	62.00
12	3.00	Phenolic Resin	1,500	17.00	11.60	5.50	80	83-12301-30-1	64.00

PRECISION TAPERED BEARING

Diameter	Width	Material	Capacity	OAH	Swivel Radius	Swivel Lead	Series	Part Number	Weight
6	3.00	Standard Polyurethane	1,100	10.00	7.16	4.00	71	73-06309-60-1	35.00
6	3.00	Mold On Rubber	700	10.00	7.16	4.00	71	73-06309-70-1	34.00
6	3.00	Phenolic Resin	1,100	10.00	7.16	4.00	71	73-06309-30-1	28.00
8	3.00	Standard Polyurethane	1,100	12.00	8.14	4.00	71	73-08309-60-1	38.00
8	3.00	Mold On Rubber	850	12.00	8.14	4.00	71	73-08309-70-1	38.00
8	3.00	H.D. T/R Polyurethane	1,100	12.00	8.14	4.00	71	73-08309-66-1	32.00
10	3.00	Standard Polyurethane	1,100	13.50	9.62	4.50	71	73-10309-60-1	45.00
10	3.00	H.D. T/R Polyurethane	1,100	13.50	9.62	4.50	71	73-10309-66-1	45.00
10	3.00	Mold On Rubber	1,100	13.50	9.62	4.50	71	73-10309-70-1	42.00
8	3.00	Standard Polyurethane	1,700	12.00	8.14	4.00	80	83-08309-60-1	58.00
8	3.00	Mold On Rubber	825	12.00	8.14	4.00	80	83-08309-70-1	58.00
8	3.00	H.D. T/R Polyurethane	1,700	12.00	8.14	4.00	80	83-08309-66-1	48.00
10	3.00	Standard Polyurethane	1,700	14.50	9.62	4.50	80	83-10309-60-1	65.00
10	3.00	Mold On Rubber	1,000	14.50	9.62	4.50	80	83-10309-70-1	55.00
10	3.00	H.D. T/R Polyurethane	1,700	14.50	9.62	4.50	80	83-10309-66-1	50.00
12	3.00	Standard Polyurethane	1,500	17.00	11.60	5.50	80	83-12309-60-1	65.00
12	3.00	Mold On Rubber	1,150	17.00	11.60	5.50	80	83-12309-70-1	62.00
12	3.00	Phenolic Resin	1,500	17.00	11.60	5.50	80	83-12309-30-1	64.00

Capacity listed is for manual operation. For powered operations, consult factory.

Estimated weight is for swivel caster. Deduct 20 percent for rigid casters.

Part Numbers listed are for the swivel casters. For rigid casters, change the last digit from 1 to 2 (i.e. 83-12309-30-2)

All dimensions are in inches. All weights are in pounds.

Overall heights and swivel radiuses listed are at NO load/weight.

CONTINUED

CASTERS SHOCK ABSORBING

PRECISION TAPERED BEARING

Diameter	Width	Material	Capacity	OAH	Swivel Radius	Swivel Lead	Series	Part Number	Weight
10	4.00	Standard Polyurethane	4,000	16.25	7.16	3.50	91	93-10409-60-1	100.00
10	4.00	Forged Steel	4,000	16.25	7.16	3.50	91	93-10409-20-1	110.00
10	5.00	H.D. Standard Polyurethane	4,000	16.25	7.16	3.50	91	93-10509-65-1	110.00
10	4.00	Standard Polyurethane	4,000	16.25	7.16	3.50	91	93-10409-60-1	100.00
10	4.00	Forged Steel	4,000	16.25	7.16	3.50	91	93-10409-20-1	110.00
10	5.00	H.D. Standard Polyurethane	4,000	16.25	7.16	3.50	91	93-10509-65-1	110.00
10	5.00	H.D. Standard Polyurethane	8,000	16.25		3.50	91	2-93-10509-65-1	250.00
18	5.00	H.D. Standard Polyurethane	20,000	25.50		4.50	91	103-18509-65-1	400.00

Capacity listed is for manual operation. For powered operations, consult factory.
 Part Numbers listed are for the swivel casters. For rigid casters, change the last digit from 1 to 2 (i.e. 83-12309-30-2)
 Estimated weight is for swivel caster. Deduct 20 percent for rigid casters.
 All dimensions are in inches. All weights are in pounds.
 Overall heights listed are at NO load/weight.
 Swivel radius is for unloaded caster.

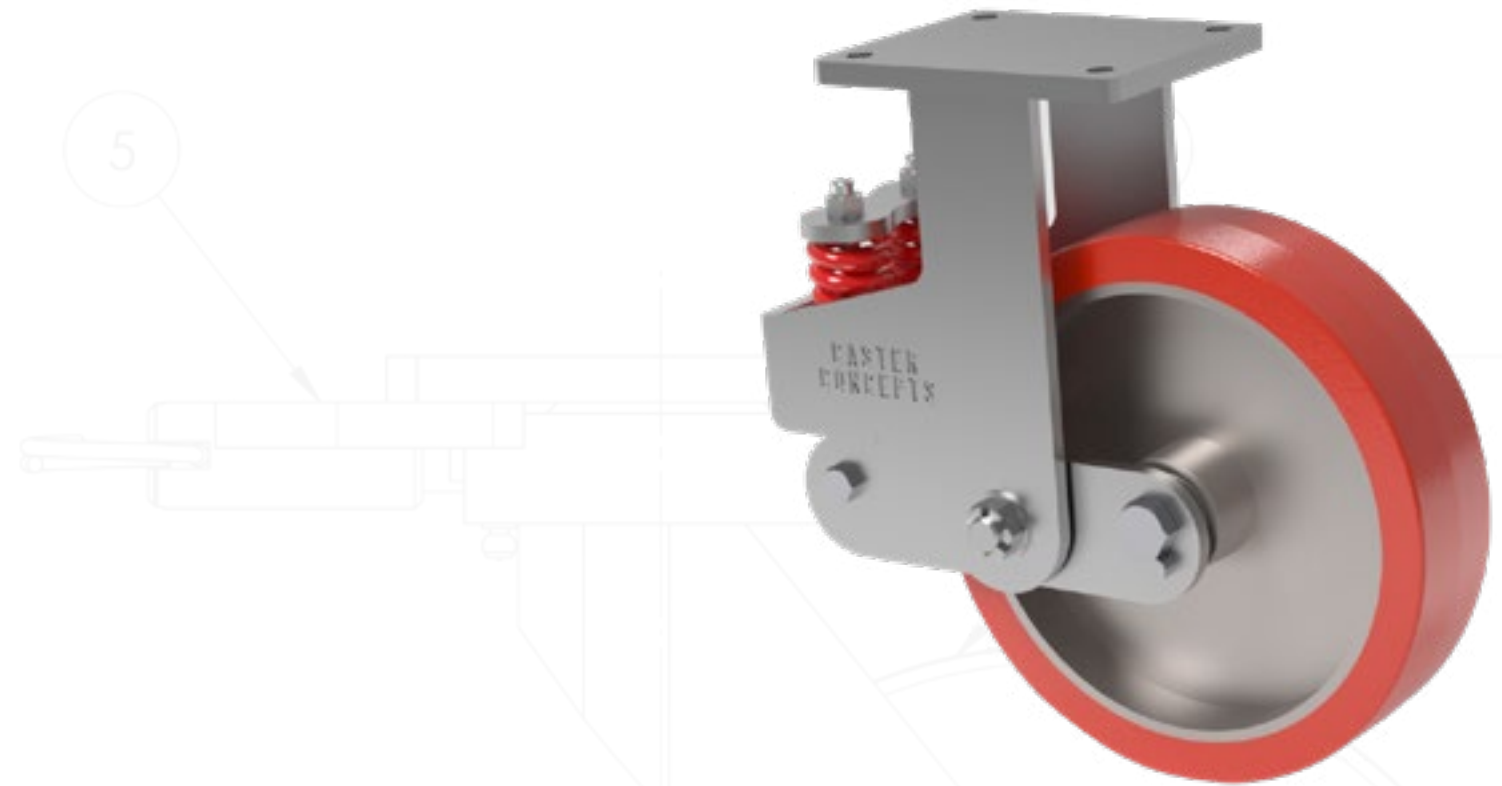

CASTERS VERTICAL MOUNTED SPRING

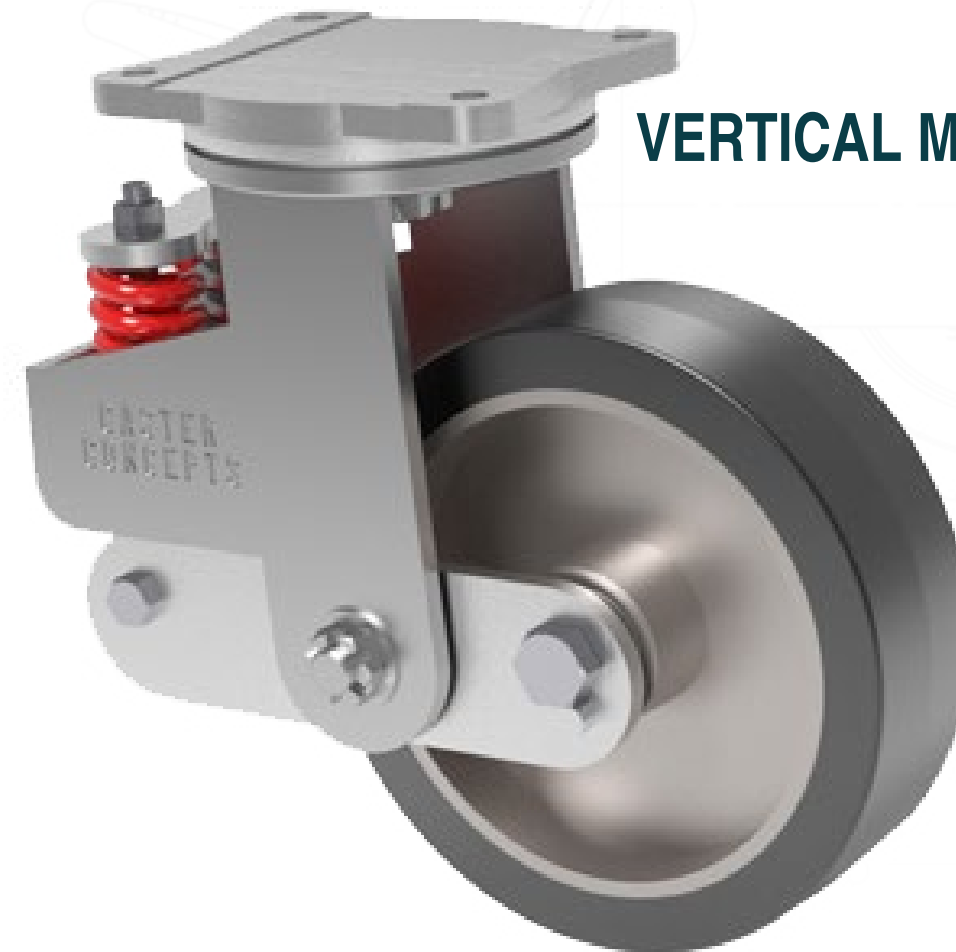

CASTERS VERTICAL MOUNTED SPRING



FEATURES

Vertical mounted spring (VMS) casters offer the highest flexibility in design. Each caster features springs that are retained on threaded rod ends for pre-load capabilities. Pre-loading the caster causes the caster to stand strong to a predetermined load before any deflection.

The VMS caster can be built with standard components and varying capacities by simply changing out the springs.

APPLICATIONS

VMS casters are ideal for jet engine dollies, aircraft jacks, in-plant trailers, trash gondolas, lift truck stabilizer casters, revolving signs and parade floats.

OPTIONS

BRAKES

Poly Lock: P
Face Contact: F

SWIVEL LOCKS

Factory Installed: L
Demountable: DL
Foot Actuated: KL

Available with dual wheels and pneumatic tires.

MAXIMUM CAPACITY
3,800 lbs.

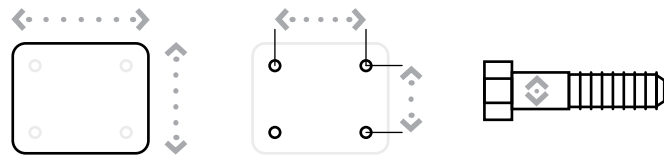

Top Plate Size	Bolt Hole Spacing	Bolt Diameter
Standard 54: 4" x 5"	2.625" x 3.625" Slotted to 3" x 3"	0.75"
Standard 64: 4.5" x 6.25"	2.438" x 4.938" Slotted to 3.375" x 5.25"	0.375"
Standard 74: 5.25" x 7.25"	3.375" x 5.25" Slotted to 4.125" x 6.125"	0.5"
Standard 84: 6" x 7.5"	4.5" x 6"	0.5"
Standard 94: 8.5" x 8.5"	7" x 7"	0.625"

CASTERS VERTICAL MOUNTED SPRING

STRAIGHT ROLLER BEARING (KINGPIN)

Diameter	Width	Material	Capacity	OAH	Swivel Radius	Swivel Lead	Series	Part Number	Weight
8	3.00	Standard Polyurethane	2,500	11.50	7.16	3.00	80	84-08301-60-1	50.00
8	3.00	Phenolic Resin	2,500	11.50	7.16	3.00	80	84-08301-30-1	42.00
8	3.00	Mold On Rubber	850	11.50	7.16	3.00	80	84-08301-70-1	47.00
8	3.00	H.D. T/R Polyurethane	2,500	11.50	7.16	3.00	80	84-08301-66-1	55.00
10	3.00	Standard Polyurethane	2,500	13.50	9.12	4.00	80	84-10301-60-1	59.00
10	3.00	Phenolic Resin	2,500	13.50	9.12	4.00	80	84-10301-30-1	46.00
10	3.00	Mold On Rubber	1,000	13.50	9.12	4.00	80	84-10301-70-1	60.00
12	3.00	Standard Polyurethane	2,500	15.50	10.11	4.00	80	84-12301-60-1	67.00
12	3.00	Phenolic Resin	2,500	15.50	10.11	4.00	80	84-12301-30-1	56.00
12	3.00	Mold On Rubber	1,150	15.50	10.11	4.00	80	84-12301-70-1	65.00
12	3.00	H.D. T/R Polyurethane	2,500	15.50	10.11	4.00	80	84-12301-66-1	70.00
10	4.00	Standard Polyurethane	3,800	13.50	9.22	4.00	90	94-10401-60-1	70.00
10	4.00	Mold On Rubber	1,500	13.50	9.22	4.00	90	94-10401-70-1	77.00
10	4.00	H.D. Standard Polyurethane	3,800	13.50	9.22	4.00	90	94-10401-65-1	79.00
12	4.00	H.D. Standard Polyurethane	3,800	15.50	10.20	4.00	90	94-12401-65-1	86.00
12	4.00	Mold On Rubber	1,600	15.50	10.20	4.00	90	94-12401-70-1	86.00
12	4.00	H.D. T/R Polyurethane	3,800	15.50	10.20	4.00	90	94-12401-66-1	86.00

PRECISION TAPERED BEARING (KINGPIN)

Diameter	Width	Material	Capacity	OAH	Swivel Radius	Swivel Lead	Series	Part Number	Weight
8	3.00	Standard Polyurethane	2,500	11.50	7.16	3.00	80	84-08309-60-1	50.00
8	3.00	Phenolic Resin	2,500	11.50	7.16	3.00	80	84-08309-30-1	42.00
8	3.00	Mold On Rubber	850	11.50	7.16	3.00	80	84-08309-70-1	47.00
8	3.00	H.D. T/R Polyurethane	2,500	11.50	7.16	3.00	80	84-08309-66-1	55.00
10	3.00	Standard Polyurethane	2,500	13.50	9.12	4.00	80	84-10309-60-1	59.00
10	3.00	Phenolic Resin	2,500	13.50	9.12	4.00	80	84-10309-30-1	46.00
10	3.00	Mold On Rubber	1,000	13.50	9.12	4.00	80	84-10309-70-1	60.00
12	3.00	Standard Polyurethane	2,500	15.50	10.11	4.00	80	84-12309-60-1	67.00
12	3.00	Phenolic Resin	2,500	15.50	10.11	4.00	80	84-12309-30-1	56.00
12	3.00	Mold On Rubber	1,150	15.50	10.11	4.00	80	84-12309-70-1	65.00
12	3.00	H.D. T/R Polyurethane	2,500	15.50	10.11	4.00	80	84-12309-66-1	70.00
10	4.00	Standard Polyurethane	3,800	13.50	9.22	4.00	90	94-10409-60-1	70.00
10	4.00	Mold On Rubber	1,500	13.50	9.22	4.00	90	94-10409-70-1	77.00
10	4.00	H.D. Standard Polyurethane	3,800	13.50	9.22	4.00	90	94-10409-65-1	79.00
12	4.00	H.D. Standard Polyurethane	3,800	15.50	10.20	4.00	90	94-12409-65-1	86.00
12	4.00	Mold On Rubber	1,600	15.50	10.20	4.00	90	94-12409-70-1	86.00
12	4.00	H.D. T/R Polyurethane	3,800	15.50	10.20	4.00	90	94-12409-66-1	86.00

*All dimensions are in inches. All weights are in pounds.
Overall heights listed are at NO load/weight.
Swivel radius is for unloaded caster.*

CASTERS COMPRESSION



FEATURES

- Swivel Section:** Sealed precision ball bearing with hardened raceways and neoprene seals.
- Legs:** 1/4" x 2" steel, formed and continuously welded on the inside and outside of the yoke base.
- Kingpin:** Kingpinless style design.
- Axle:** 1/2" diameter.
- Lubrication:** Sealed ball bearing is lubricated and requires zero maintenance. Standard ball bearings are pre-lubricated before shipping.
- Wheels:** 8" diameter wheels are available with sealed precision ball bearings.
- Finish:** Clear zinc plating.

BENEFITS

The compression caster integrates a dampening unit into the rig of the caster. This reduces the noise, vibration, and cushions the ride. The compression series offers a maintenance-free solution with its sealed precision ball bearing in the swivel section and in the wheels. The smooth rotating action and extended lead help lower ergonomic forces. A standard ball bearing swivel section is also available.

APPLICATIONS

Excellent for instances where workplace safety related to hearing conservation is a concern. The compression caster can reduce noise levels by as much as 15 dBA. The vibration dampening properties are ideal for transporting fragile components like electronics.

OPTIONS

- BRAKES**
- Poly Lock: P
 - Face Contact: F
- SWIVEL LOCKS**
- Factory Installed: L
 - Demountable: DL
 - Foot Actuated: KL

Contact factory for other configurations, part numbers, and pricing.

CASTERS COMPRESSION

PRECISION BALL BEARING (51 SERIES)

Diameter	Width	Material	Capacity	OAH	Swivel Radius	Swivel Lead	Series	Part Number	Weight
8	2.00	T/R Polyurethane	1,240	10.13	7.07	3.00	51CC	51CC-08202-61-1	22.23
8	2.00	T/R-95 Polyurethane	1,500	10.13	7.07	3.00	51CC	51CC-08202-91-1	22.23
8	2.00	HPPT Polyurethane	1,500	10.13	7.07	3.00	51CC	51CC-08202-90-1	22.23
8	2.00	ErgoTread	1,178	10.13	7.07	3.00	51CC	51CC-08202-40-1	22.23

PRECISION BALL BEARING (55 SERIES)

Diameter	Width	Material	Capacity	OAH	Swivel Radius	Swivel Lead	Series	Part Number	Weight
8	2.00	T/R Polyurethane	1,000	10.13	7.07	3.00	55CC	55CC-08202-61-1	22.23
8	2.00	T/R-95 Polyurethane	1,000	10.13	7.07	3.00	55CC	55CC-08202-91-1	22.23
8	2.00	HPPT Polyurethane	1,000	10.13	7.07	3.00	55CC	55CC-08202-90-1	22.23
8	2.00	ErgoTread	1,000	10.13	7.07	3.00	55CC	55CC-08202-40-1	22.23

PRECISION BALL BEARING (57 SERIES)

Diameter	Width	Material	Capacity	OAH	Swivel Radius	Swivel Lead	Series	Part Number	Weight
8	2.00	T/R Polyurethane	1,240	10.75	7.07	3.00	57CC	57CC-08202-61-1	22.23
8	2.00	T/R-95 Polyurethane	1,500	10.75	7.07	3.00	57CC	57CC-08202-91-1	22.23
8	2.00	HPPT Polyurethane	1,500	10.75	7.07	3.00	57CC	57CC-08202-90-1	22.23
8	2.00	ErgoTread	1,178	10.75	7.07	3.00	57CC	57CC-08202-40-1	22.23

MAXIMUM CAPACITY

1,500 lbs.

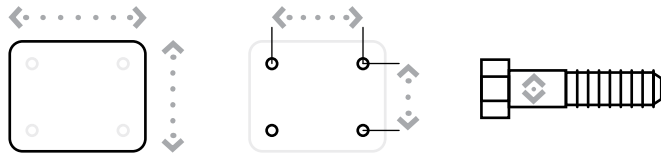

Top Plate Size	Bolt Hole Spacing	Bolt Diameter
51CC & 55CC Series Standard: 4" x 5"	2.625" x 3.625" Slotted to 3" x 3"	0.375"
57CC Series Standard: 4.5" x 6.25"	2.438" x 4.938" Slotted to 3.375" x 5.25"	0.5"
51CC & 55CC Optional Top Plate 60: 4.5" x 6.25"	2.438" x 4.938" Slotted to 3.375" x 5.25"	0.5"
57CC Series Optional Top Plate 70: 5" x 7.25"	3.375" x 5.25" Slotted to 4.125" x 6.125"	0.5"
57CC Series Optional Top Plate 75: 6" x 7"	4.62" x 5.5"	0.5"

Capacity listed is for manual operation. For powered operations, consult factory.
 Roller bearing and tapered bearings are available, consult factory for additional information.
 Part Numbers listed are for the swivel caster. For rigid casters, change the last digit from 1 to 2 (i.e. XXCC-08202-XX-2).
 Estimated weight is for swivel caster. Deduct 20 percent of swivel caster weight for rigid casters.
 All dimensions are in inches. All weights are in pounds.
 Overall heights listed are at NO load/weight.
 Swivel radius is for unloaded caster.

CASTERS PNEUMATIC



MAXIMUM CAPACITY

7,260 lbs.

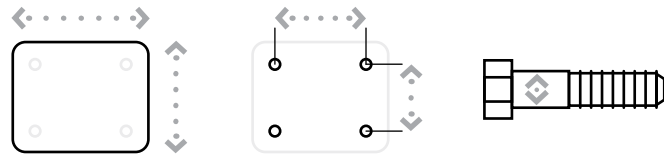

Top Plate Size	Bolt Hole Spacing	Bolt Diameter
Standard 50: 4" x 5"	2.625" x 3.625" Slotted to 3" x 3"	0.375"
Standard 51: 4" x 5"	2.625" x 3.625" Slotted to 3" x 3"	0.375"
Standard 60: 4.5" x 6.25"	2.438" x 4.93" Slotted to 3.375" x 5.25"	0.5"
Standard 61: 4.5" x 6.25"	2.438" x 4.938" Slotted to 3.375" x 5.25"	0.5"
Standard 70: 5.25" x 7.5"	3.375" x 5.25" Slotted to 4.125" x 6.125"	0.5"
Standard 71: 5" x 7.25"	3.375" x 5.25" Slotted to 4.125" x 6.125"	0.5"
Standard 80: 6" x 7.5"	4.5" x 6"	0.5"
Standard 81: 6.25" x 7.63"	4.5" x 6"	0.5"
Standard 90: 8.5" x 8.5"	7" x 7"	0.625"
Standard 91: 8.5" x 8.5"	7" x 7"	0.625"

FEATURES

The complete line of single or dual-wheel pneumatic casters offers load carrying capacities from 320 pounds to 7,260 pounds. The swivel sections are constructed of C-1045 hot forged steel with double row ball bearing swivels for long service life. The 80 Series and larger casters have tapered thrust bearings in the swivel. The legs are continuously welded both inside and outside for added strength. Standard: Wheels 16" and larger are supplied with high-speed tapered bearings standard.

APPLICATIONS

Excellent shock absorbing benefits make these casters ideal for uneven floors and indoor and outdoor rough terrain. They are ideal on aircraft ground support equipment, helicopter dollies, roof maintenance equipment, mobile construction shelters, and other equipment carrying electronics or other highly sensitive materials.

BENEFITS

These casters offer the greatest possible protection to both loads and floors. The pneumatic tires cushion the load and roll over obstructions with ease. These casters provide longer wheel life, less maintenance and high shock absorbency. The long swivel offset aids in swiveling and tracking in towing applications. When the caster is subjected to towing, tapered bearings are recommended.

OPTIONS

BRAKES

Pneumatic Poly Cam: PP*
Face Contact: F

SWIVEL LOCKS

Factory Installed: L
Demountable: DL
Foot Actuated: KL

SEALED SWIVEL SECTION SSW

TOE GUARD TG

* For single wheel configuration only.

CASTERS PNEUMATIC

STRAIGHT ROLLER BEARING (KINGPIN)

Diameter	Size	Ply Rating	Capacity	OAH	Swivel Radius	Swivel Lead	Series	Part Number	Weight
8	2.80/4	4	295	11.00	6.79	2.63	50	50-08301-76-1	13.00
10	4.10/4	4	352	13.00	8.43	3.25	50	50-10351-76-1	15.00
12	4.10/6	4	675	15.50	9.71	3.50	50	50-12401-76-1	18.00
8	2.80/4	4	590	11.00		2.63	50	52-08301-76-1	20.00
10	4.10/4	4	704	13.00		3.25	50	52-10351-76-1	22.50
12	4.10/6	4	1,350	15.50		3.50	50	52-12401-76-1	33.00
8	2.80/4	4	295	11.00	6.79	2.63	60	60-08301-76-1	13.00
10	4.10/4	4	352	13.00	8.43	3.25	60	60-10351-76-1	15.00
12	4.10/6	4	675	15.50	9.71	3.50	60	60-12401-76-1	18.00
8	2.80/4	4	590	11.00		2.63	60	62-08301-76-1	20.00
10	4.10/4	4	704	13.00		3.25	60	62-10351-76-1	22.50
12	4.10/6	4	1,350	15.50		3.50	60	62-12401-76-1	30.00
14	5.30/6	4	710	17.75	11.23	4.00	70	70-14451-76-1	31.00
12	4.10/6	4	1,350	15.50		4.00	70	72-12401-76-1	36.00
14	5.30/6	4	1,420	17.75		4.00	70	72-14451-76-1	45.00

STRAIGHT ROLLER BEARING (KINGPINLESS)

Diameter	Size	Ply Rating	Capacity	OAH	Swivel Radius	Swivel Lead	Series	Part Number	Weight
8	2.80/4	4	295	11.00	6.79	2.63	51	51-08301-76-1	13.00
10	4.10/4	4	352	13.00	8.43	3.25	51	51-10351-76-1	15.00
12	4.10/6	4	675	15.50	9.71	3.50	51	51-12401-76-1	18.00
8	2.80/4	4	590	11.00		2.63	51	2-51-08301-76-1	20.00
10	4.10/4	4	704	13.00		3.25	51	2-51-10351-76-1	22.50
12	4.10/6	4	1,350	15.50		3.50	51	2-51-12401-76-1	33.00
8	2.80/4	4	295	11.00	6.79	2.63	61	61-08301-76-1	13.00
10	4.10/4	4	352	13.00	8.43	3.25	61	61-10351-76-1	15.00
12	4.10/6	4	675	15.50	9.71	3.50	61	61-12401-76-1	18.00
8	2.80/4	4	590	11.00		2.63	61	2-61-08301-76-1	20.00
10	4.10/4	4	704	13.00		3.25	61	2-61-10351-76-1	22.50
12	4.10/6	4	1,350	15.50		3.50	61	2-61-12401-76-1	30.00

CONTINUED

All dimensions are in inches. All weights are in pounds.

CASTERS PNEUMATIC

STRAIGHT ROLLER BEARING (KINGPINLESS)

Diameter	Size	Ply Rating	Capacity	OAH	Swivel Radius	Swivel Lead	Series	Part Number	Weight
14	5.30/6	4	710	17.75	11.23	4.00	71	71-14451-76-1	31.00
12	4.10/6	4	1,350	15.50		4.00	71	2-71-12401-76-1	36.00
14	5.30/6	4	1,420	17.75		4.00	71	2-71-14451-76-1	45.00

PRECISION TAPERED BEARING (KINGPIN)

Diameter	Size	Ply Rating	Capacity	OAH	Swivel Radius	Swivel Lead	Series	Part Number	Weight
16	4.80/8	6	1,230	19.13	12.73	4.50	70	70-16609-76-1	37.00
16	4.80/8	6	2,460	19.13		4.50	70	72-16609-76-1	55.00
16	4.80/8	6	1,230	19.13	12.24	12.24	80	80-16609-76-1	45.00
18	5.70/8	6	1,560	21.50	13.83	13.83	80	80-18609-76-1	55.00
18	5.70/8	8	1,655	21.50	13.83	13.83	80	80-18609-77-1	56.00
16	4.80/8	6	2,460	19.13		4.50	80	82-16609-76-1	71.00
18	5.70/8	6	3,120	21.50		4.50	80	82-18609-76-1	82.00
18	5.70/8	8	3,310	21.50		4.50	80	82-18609-77-1	84.00
21	6.90/9	10	2,420	24.25	15.88	5.00	90	90-21609-76-1	80.00
23	6.50/10	10	2,775	26.25	16.82	5.00	90	90-23609-76-1	87.00
25	7.50/10	10	3,630	28.75	17.90	5.00	90	90-25609-76-1	90.00
21	6.90/9	10	4,840	24.25		5.00	90	92-21609-76-1	130.00
23	6.50/10	10	5,550	26.25		5.00	90	92-23609-76-1	135.00
25	7.50/10	10	7,260	28.75		5.00	90	92-25609-76-1	142.00

PRECISION TAPERED BEARING (KINGPINLESS)

Diameter	Size	Ply Rating	Capacity	OAH	Swivel Radius	Swivel Lead	Series	Part Number	Weight
16	4.80/8	6	1,230	19.13	12.73	4.50	71	71-16609-76-1	37.00
16	4.80/8	6	2,460	19.13		4.50	71	2-71-16609-76-1	55.00
16	4.80/8	6	1,230	19.13	12.24	4.00	81	81-16609-76-1	45.00
18	5.70/8	6	1,560	21.50	13.83	4.50	81	81-18609-76-1	56.00
18	5.70/8	8	1,655	21.50	13.83	4.50	81	81-18609-77-1	56.00
16	4.80/8	6	2,460	19.13		4.50	81	2-81-16609-76-1	71.00
18	5.70/8	6	3,120	21.50		4.50	81	2-81-18609-76-1	82.00
18	5.70/8	8	3,310	21.50		4.50	81	2-81-18609-77-1	84.00
21	6.90/9	10	2,420	24.25	15.88	5.00	91	91-21609-76-1	80.00
23	6.50/10	10	2,775	26.25	16.82	5.00	91	91-23609-76-1	87.00
25	7.50/10	10	3,630	28.75	17.90	5.00	91	91-25609-76-1	90.00
21	6.90/9	10	4,840	24.25		5.00	91	2-91-21609-76-1	130.00
23	6.50/10	10	5,550	26.25		5.00	91	2-91-23609-76-1	135.00
25	7.50/10	10	7,260	28.75		5.00	91	2-91-25609-76-1	142.00

CONTINUED

CASTERS SEMI-PNEUMATIC

PRECISION TAPERED BEARING (KINGPIN)

Diameter	Size	Capacity	OAH	Swivel Radius	Swivel Lead	Series	Part Number	Weight
12	200 x 8	1,200	15.50		3.50	50	50-12409-78-1	
12	200 x 8	2,400	15.50		3.50	50	52-12409-78-1	
12	200 x 8	1,200	15.50		3.50	60	60-12409-78-1	
12	200 x 8	2,400	15.50		3.50	60	62-12409-78-1	
14	300 x 8	1,500	17.75		4.00	70	70-14409-78-1	
16	400 x 8	2,900	19.13		4.50	70	70-16509-78-1	
12	200 x 8	2,400	15.50		4.00	70	72-12409-78-1	
14	300 x 8	3,000	17.75		4.00	70	72-14409-78-1	
16	400 x 8	2,900	19.13		4.50	70	72-16509-78-1	
16	400 x 8	2,900	19.13		4.00	80	80-16509-78-1	
18	500 x 8	3,300	21.50		4.50	80	80-18509-78-1	
16	400 x 8	5,000	19.13		4.50	80	82-16509-78-1	
18	500 x 8	5,000	21.50		4.50	80	82-18509-78-1	
16	400 x 8	2,900	19.00	15.88	5.00	90	90-16509-78-1	
18	500 x 8	3,300	21.00	16.82	5.00	90	90-18509-78-1	
16	400 x 8	5,800	19.00			90	92-16509-78-1	
18	500 x 8	6,600	21.00			90	92-18509-78-1	

PRECISION TAPERED BEARING (KINGPINLESS)

Diameter	Size	Capacity	OAH	Swivel Radius	Swivel Lead	Series	Part Number	Weight
12	200 x 8	1,200	15.50		3.50	51	51-12409-78-1	
12	200 x 8	2,400	15.50		3.50	51	2-51-12409-78-1	
12	200 x 8	1,200	15.50	9.71	3.50	61	61-12409-78-1	
12	200 x 8	2,400	15.50		3.50	61	2-61-12409-78-1	
14	300 x 8	1,500	17.75	11.23	4.00	71	71-14409-78-1	
16	400 x 8	2,900	19.13	11.23	4.50	71	71-16509-78-1	
12	200 x 8	2,400	15.50		4.00	71	2-71-12409-78-1	
14	300 x 8	3,000	17.75		4.00	71	2-71-14409-78-1	
16	400 x 8	3,500	19.13		4.50	71	2-71-16509-78-1	
16	400 x 8	2,900	19.13	13.83	4.00	81	81-16509-78-1	
18	500 x 8	3,300	21.50	13.83	4.50	81	81-18509-78-1	
16	400 x 8	5,800	19.13		4.50	81	2-81-16509-78-1	
18	500 x 8	6,600	21.50		4.50	81	2-81-18509-78-1	

CONTINUED

All dimensions are in inches. All weights are in pounds.

CASTERS SEMI-PNEUMATIC

PRECISION TAPERED BEARING (KINGPINLESS)

Diameter	Size	Capacity	OAH	Swivel Radius	Swivel Lead	Series	Part Number	Weight
16	400 x 8	2,900	19.00	15.88	5.00	90	91-16509-78-1	
18	500 x 8	3,300	21.00	17.90	5.00	90	91-18509-78-1	
16	400 x 8	5,800	19.75	13.21	4.00	91	2-91-16509-78-1	

All dimensions are in inches. All weights are in pounds.



CASTERS V-GROOVE

CASTERS V-GROOVE



FEATURES

V-groove castor swivel sections are hot forged from C-1045 steel. The wheels are highly adaptable and can operate on angle iron track or on normal floor surfaces. A relief groove at the base of the “V” equalizes the load to each face of the angle track. In addition, all wheel faces and “V” grooves are machined concentric to the bore for proper tracking. The wheel bearings are either straight roller bearings or precision tapered roller bearings.

APPLICATIONS

V-groove wheels are used for exceptionally heavy loads where precise alignment or indexing or equipment is necessary. These casters are capable of guiding industrial ovens, paint booths and other similar equipment.

BENEFITS

V-groove wheels are constructed of premium G-3000 gray iron castings or hot forged C-1030 steel. The 90 degree grooves are accurately machined into the face of the wheels. A relief groove at the base of the “V” directs the load to each face of the angle track when in use.

V-groove wheels can be used on a track, flat surface or both without fear of damage.

Exceptionally strong and ideal for heavy loads, the V-groove wheels are able to be machined out for keyway or various bore sizes.

Wheel material codes: Cast iron (15); heavy-duty cast iron (16); forged steel (25); heavy-duty forged steel (26).

MAXIMUM CAPACITY
15,000 lbs.

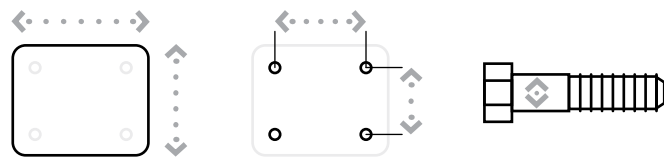

Top Plate Size	Bolt Hole Spacing	Bolt Diameter
Standard 30: 4" x 4.5"	2.625" x 3.625" Slotted to 3" x 3"	0.375"
Standard 50: 4" x 5"	2.625" x 3.625" Slotted to 3" x 3"	0.375"
Standard 60: 4.5" x 6.25"	2.438" x 4.93" Slotted to 3.375" x 5.25"	0.5"
Standard 70: 5" x 7.25"	3.375" x 5.25" Slotted to 4.125" x 6.125"	0.5"
Standard 80: 6" x 7.5"	4.5" x 6"	0.5"
Standard 90/91/95: 8.5" x 8.5"	7" x 7"	0.625"

CASTERS V-GROOVE

STRAIGHT ROLLER BEARING (KINGPIN)

Diameter	Width	Material	Capacity	OAH	Swivel Lead	Series	Part Number	Weight
4	2.00	Cast Iron	1,000	5.63	1.50	50	50-04201-15-1	7.00
4	2.00	Cast Iron	1,000	5.63	1.50	60	60-04201-15-1	10.00
6	2.50	Cast Iron	2,000	7.50	2.50	65	65-06251-15-1	23.00
6	2.50	Cast Iron	2,500	8.00	2.50	70	70-06251-15-1	27.00
8	2.50	Cast Iron	2,500	10.50	2.50	70	70-08251-15-1	35.00
8	3.00	Cast Iron	3,500	10.50	2.50	70	70-08301-15-1	40.00
8	3.00	Forged Steel	3,500	10.50	2.50	70	70-08301-25-1	33.00
10	3.00	Cast Iron	3,500	12.50	2.50	70	70-10301-15-1	45.00
6	3.00	Forged Steel	5,000	8.50	2.50	80	80-06301-25-1	45.00
8	3.00	Forged Steel	5,000	10.50	2.50	80	80-08301-25-1	45.00
8	4.00	Forged Steel	5,000	10.50	2.50	80	80-08401-25-1	55.00
10	3.00	H.D. Cast Iron	4,000	12.50	2.50	80	80-10301-16-1	55.00
10	3.00	H.D. Forged Steel	5,000	12.50	2.50	80	80-10301-26-1	55.00
10	4.00	Forged Steel	5,000	12.50	2.50	80	80-10401-25-1	74.00
6	3.00	Forged Steel	6,000	8.50	2.50	85	85-06301-25-1	45.00
8	4.00	Forged Steel	8,400	10.50	2.50	85	85-08401-25-1	55.00
10	3.00	H.D. Forged Steel	6,000	12.50	2.50	85	85-10301-26-1	53.00
10	4.00	Forged Steel	8,400	12.50	2.50	85	85-10401-25-1	74.00
6	3.00	Forged Steel	6,000	9.00	2.25	90	90-06301-25-1	60.00
8	4.00	Forged Steel	8,000	11.00	2.25	90	90-08401-25-1	73.00
10	3.00	H.D. Cast Iron	4,000	13.00	2.50	90	90-10301-16-1	65.00
10	3.00	H.D. Forged Steel	8,000	13.00	2.50	90	90-10301-26-1	68.00
10	4.00	Forged Steel	8,000	13.00	2.50	90	90-10401-25-1	89.00
8	4.00	Forged Steel	8,400	11.00	2.25	95	95-08401-25-1	73.00
10	4.00	Forged Steel	8,400	13.00	2.50	95	95-10401-25-1	89.00

STRAIGHT ROLLER BEARING (KINGPINLESS)

Diameter	Width	Material	Capacity	OAH	Swivel Lead	Series	Part Number	Weight
12	4.00	Ductile Iron	8,400	15.50	2.50	91	91-12401-16-1	141.00
12	5.00	Ductile Iron	9,500	15.50	2.50	91	91-12501-16-1	157.00

Capacity listed is for manual operation. For powered operations, consult factory.
Part Numbers listed are for the swivel casters.
For rigid casters, change the last digit from 1 to 2 (i.e. 95-10409-26-1-2).
Estimated weight is for swivel caster. Deduct 20 percent for rigid casters.
For specific V-groove dimensions, see page 140. All dimensions are in inches. All weights are in pounds.

CONTINUED

CASTERS V-GROOVE

PRECISION TAPERED BEARING (KINGPIN)

Diameter	Width	Material	Capacity	OAH	Swivel Lead	Series	Part Number	Weight
6	2.50	Cast Iron	2,000	7.50	2.50	65	65-06259-15-1	23.00
8	3.00	Cast Iron	2,000	10.13	2.50	65	65-08309-15-1	36.00
6	2.50	Cast Iron	2,500	8.00	2.50	70	70-06259-15-1	27.00
8	2.50	Cast Iron	2,500	10.50	2.50	70	70-08259-15-1	35.00
8	3.00	Cast Iron	3,500	10.50	2.50	70	70-08309-15-1	40.00
8	3.00	Forged Steel	3,500	10.50	2.50	70	70-08309-25-1	33.00
10	3.00	Cast Iron	3,500	12.50	2.50	70	70-10309-15-1	45.00
6	3.00	Forged Steel	5,000	8.50	2.50	80	80-06309-25-1	45.00
8	3.00	Forged Steel	5,000	10.50	2.50	80	80-08309-25-1	45.00
8	4.00	Forged Steel	5,000	10.50	2.50	80	80-08409-25-1	55.00
10	3.00	H.D. Cast Iron	4,000	12.50	2.50	80	80-10309-16-1	55.00
10	3.00	H.D. Forged Steel	5,000	12.50	2.50	80	80-10309-26-1	55.00
10	4.00	Forged Steel	5,000	12.50	2.50	80	80-10409-25-1	74.00
6	3.00	Forged Steel	10,000	8.50	2.50	85	85-06309-25-1	45.00
8	4.00	Forged Steel	10,000	10.50	2.50	85	85-08409-25-1	55.00
10	3.00	H.D. Forged Steel	6,000	12.50	2.50	85	85-10309-26-1	53.00
10	4.00	Forged Steel	10,000	12.50	2.50	85	85-10409-25-1	74.00
6	3.00	Forged Steel	10,000	9.00	2.25	90	90-06309-25-1	60.00
8	4.00	Forged Steel	8,000	11.00	2.25	90	90-08409-25-1	73.00
10	3.00	H.D. Cast Iron	4,000	13.00	2.50	90	90-10309-16-1	65.00
10	3.00	H.D. Forged Steel	8,400	13.00	2.50	90	90-10309-26-1	68.00
10	4.00	Forged Steel	8,000	13.00	2.50	90	90-10409-25-1	89.00
6	3.00	H.D. Forged Steel	15,000	9.00	2.25	95	95-06309-26-1	50.00
8	4.00	Forged Steel	10,000	11.00	2.25	95	95-08409-25-1	73.00
8	4.00	H.D. Forged Steel	15,000	11.00	2.25	95	95-08409-26-1	73.00
10	4.00	Forged Steel	10,000	13.00	2.50	95	95-10409-25-1	89.00
10	4.00	H.D. Forged Steel	15,000	13.00	2.50	95	95-10409-26-1	89.00

PRECISION TAPERED BEARING (KINGPINLESS)

Diameter	Width	Material	Capacity	OAH	Swivel Lead	Series	Part Number	Weight
12	4.00	Ductile Iron	10,000	15.50	2.50	91	91-12409-16-1	141.00
12	5.00	Ductile Iron	10,000	15.50	2.50	91	91-12509-16-1	157.00

Capacity listed is for manual operation. For powered operations, consult factory.

Part Numbers listed are for the swivel casters. For rigid casters, change the last digit from 1 to 2 (i.e. 95-10409-26-1-2)

Estimated weight is for swivel caster. Deduct 20 percent for rigid casters.

For specific V-groove dimensions, see page 140. All dimensions are in inches. All weights are in pounds.



CASTERS FLANGED

CASTERS FLANGED



FEATURES

The flanged wheels are constructed of premium cast iron, ductile iron, or forged steel for high strength and long wear. These wheels are designed to operate on a steel track for minimal guidance and rolling effort. The flanged wheel casters are rigid casters used for locating fixtures in a precise position for indexing through a work cycle.

APPLICATIONS

Applications include production lines, foundry cooling lines, mobile cranes, amusement parks, trollies, autoclave tooling, etc.

Note: No brake options for tapered bearings on these casters.

MAXIMUM CAPACITY

12,000 lbs.

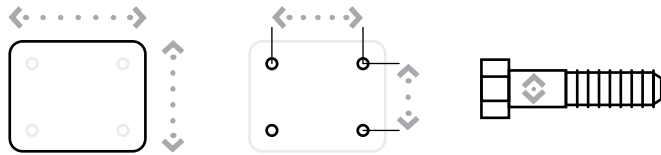

Top Plate Size	Bolt Hole Spacing	Bolt Diameter
Standard 30: 4" x 4.5"	2.625" x 3.625" Slotted to 3" x 3"	0.375"
Standard 50: 4" x 5"	2.625" x 3.625" Slotted to 3" x 3"	0.375"
Standard 60: 4.5" x 6.25"	2.438" x 4.93" Slotted to 3.375" x 5.25"	0.5"
Standard 70: 5" x 7.25"	3.375" x 5.25" Slotted to 4.125" x 6.125"	0.5"
Standard 80: 6" x 7.5"	4.5" x 6"	0.5"
Standard 90/91/95: 8.5" x 8.5"	7" x 7"	0.625"

CASTERS FLANGED

STRAIGHT ROLLER BEARING (SINGLE FLANGED)

Diameter	Width	Material	Capacity	OAH	Series	Part Number	Weight
3.50	1.30	Cast Iron	1,000	5.38	50	50-03101-18-2	10.00
3.50	1.30	Cast Iron	1,000	5.38	60	60-03101-18-2	10.00
7.87	1.75	Cast Iron	2,500	10.06	65	65-08201-18-2	29.00
6.13	1.69	Cast Iron	3,000	8.06	70	70-06201-18-2	36.00
7.87	1.75	Cast Iron	2,500	10.44	70	70-08201-18-2	30.00
7.87	2.25	Cast Iron	3,500	10.44	70	70-07251-18-2	30.00
8.00	2.25	Cast Iron	3,500	10.50	70	70-08251-18-2	34.00
5.00	2.06	Forged Steel	6,000	8.00	80	80-05201-28-2	30.00
6.13	1.69	Cast Iron	3,000	8.56	80	80-06201-18-2	39.00
7.87	2.25	Cast Iron	3,500	10.44	80	80-07251-18-2	33.00
8.00	2.25	Cast Iron	3,500	10.50	80	80-08251-18-2	37.00
8.00	2.38	Forged Steel	6,000	10.50	80	80-08201-28-2	63.00
5.00	2.06	Forged Steel	6,000	8.50	90	90-05201-28-2	30.00
8.00	2.38	Forged Steel	6,000	11.00	90	90-08201-28-2	63.00
15.00	2.50	Ductile Iron	8,000	18.44	95	95-15251-18-2	

PRECISION TAPERED BEARING (SINGLE FLANGED)

Diameter	Width	Material	Capacity	OAH	Series	Part Number	Weight
7.87	1.75	Cast Iron	2,500	10.06	65	65-08209-18-2	29.00
6.13	1.69	Cast Iron	3,500	8.06	70	70-06209-18-2	36.00
7.87	1.75	Cast Iron	2,500	10.44	70	70-08209-18-2	30.00
7.87	2.25	Cast Iron	3,500	10.44	70	70-07259-18-2	30.00
8.00	2.25	Cast Iron	3,500	10.50	70	70-08259-18-2	34.00
5.00	2.06	Forged Steel	10,000	8.00	80	80-05209-28-2	30.00
6.13	1.69	Cast Iron	5,000	8.56	80	80-06209-18-2	39.00
7.87	2.25	Cast Iron	3,500	10.44	80	80-07259-18-2	33.00
8.00	2.25	Cast Iron	3,500	10.50	80	80-08259-18-2	37.00
8.00	2.38	Forged Steel	10,000	10.50	80	80-08209-28-2	63.00
5.00	2.06	Forged Steel	10,000	8.50	90	90-05209-28-2	30.00
8.00	2.38	Forged Steel	10,000	11.00	90	90-08209-28-2	63.00
10.00	4.00	Ductile Iron	12,000	14.50	95	95-10409-18-2	150.00

Capacity listed is for manual operation. For powered operations, consult factory.
All dimensions are in inches. All weights are in pounds.
For rail information and flanged wheel dimensions see page 144.

CONTINUED

CASTERS FLANGED

STRAIGHT ROLLER BEARING (DUAL FLANGED)

Diameter	Width	Material	Capacity	OAH	Series	Part Number	Weight
6.00	2.13	Cast Iron	3,500	8.00	70	70-06201-19-2	38.00
5.00	1.69	Forged Steel	6,000	8.00	80	80-05201-29-2	32.00
6.00	2.13	Cast Iron	5,000	8.50	80	80-06201-19-2	41.00
8.00	1.76	Forged Steel	6,000	10.50	80	80-08201-29-2	65.00
5.00	1.69	Forged Steel	6,000	8.50	90	90-05201-29-2	32.00
8.00	1.76	Forged Steel	6,000	11.00	90	90-08201-29-2	65.00

PRECISION TAPERED BEARING (DUAL FLANGED)

Diameter	Width	Material	Capacity	OAH	Series	Part Number	Weight
6.00	2.13	Cast Iron	3,500	8.00	70	70-06209-19-2	38.00
5.00	1.69	Forged Steel	10,000	8.00	80	80-05209-29-2	32.00
6.00	2.13	Cast Iron	6,000	8.50	80	80-06209-19-2	41.00
8.00	1.76	Forged Steel	10,000	10.50	80	80-08209-29-2	65.00
8.00	1.76	Forged Steel	10,000	11.00	90	90-08209-29-2	65.00
5.00	1.69	Forged Steel	10,000	8.50	90	90-05209-29-2	32.00
10.00	3.00	Ductile Iron	12,000	14.50	95	95-10309-19-2	150.00

Capacity listed is for manual operation. For powered operations, consult factory.
All dimensions are in inches. All weights are in pounds. For rail information and flanged wheel dimensions see page 144.



WHEELS
V-GROOVE

WHEELS V-GROOVE



MAXIMUM CAPACITY

15,000 lbs.

FEATURES

Bearings: Roller, tapered, bearingless.

Temperature: Maximum to 800° F with proper bearing and lubrication.

Standard: All 1-1/2" and 2" width wheels with 3/4" roller bearings are supplied with 1/2" spanner bushing.

APPLICATIONS

Excellent for guided industrial applications, assembly lines, paint lines and material handling where precise alignment is necessary.

BENEFITS

V-groove wheels are constructed of premium G-3000 gray iron castings or hot forged C-1030 steel. The 90 degree grooves are accurately machined into the face of the wheels. A relief groove at the base of the "V" directs the load to each face of the angle track when in use.

V-groove wheels can be used on a track, flat surface or both without fear of damage.

Exceptionally strong and ideal for heavy loads, the V-groove wheels are able to be machined out for keyway or various bore sizes.

Wheel material codes: Cast iron (15); heavy-duty cast iron (16); forged steel (25); heavy-duty forged steel (26).

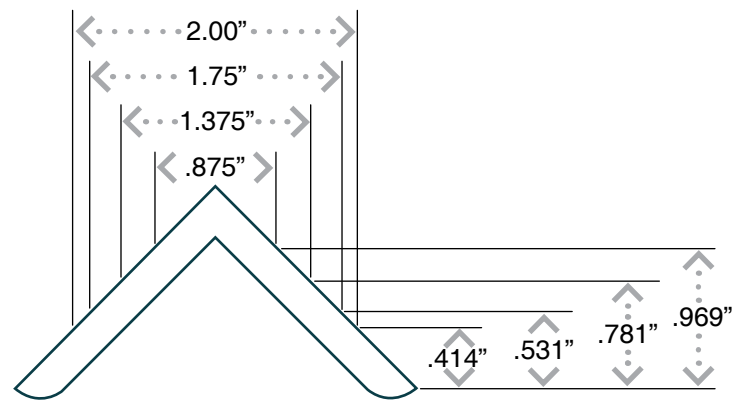

V-GROOVE WIDTH

2.00" x 2.00" ANGLE IRON

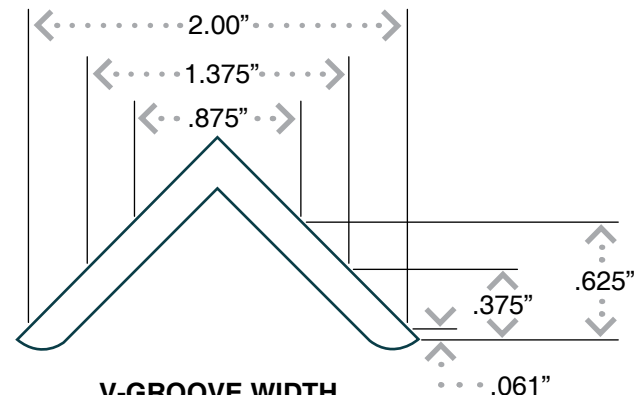

V-GROOVE WIDTH

1.50" x 1.50" ANGLE IRON

WHEELS V-GROOVE

STRAIGHT ROLLER BEARING

Diameter	Width	Material	Capacity	Hub Length	Bore	Width x Depth	Part Number	Weight
4	2.00	Cast Iron	1,000	2 3/16	3/4	7/8 x 7/16	04201-15-12	5.00
6	2.00	Cast Iron	1,000	2 3/16	3/4	7/8 x 7/16	06201-15-12	5.00
6	2.50	Cast Iron	2,500	3 1/4	1	7/8 x 7/16	06251-15-16	10.00
6	2.50	Cast Iron	2,500	3 1/4	1 1/4	7/8 x 7/16	06251-15-20	10.00
6	3.00	Forged Steel	6,000	3 1/4	1 1/4	1-3/8 x 11/16	06301-25-20	20.00
6	3.00	Forged Steel	6,000	3 1/4	1 1/2	1-3/8 x 11/16	06301-25-24	20.00
8	2.50	Cast Iron	2,500	3 1/4	1	7/8 x 7/16	08251-15-16	20.00
8	2.50	Cast Iron	2,500	3 1/4	1 1/4	7/8 x 7/16	08251-15-20	20.00
8	3.00	Cast Iron	4,000	3 1/4	1	7/8 x 7/16	08301-15-16	22.00
8	3.00	Cast Iron	4,000	3 1/4	1 1/4	7/8 x 7/16	08301-15-20	22.00
8	3.00	H.D. Cast Iron	4,500	3 1/4	1 1/4	1-3/8 x 11/16	08301-16-20	24.00
8	3.00	H.D. Cast Iron	4,500	3 1/4	1 1/2	1-3/8 x 11/16	08301-16-24	24.00
8	3.00	Forged Steel	5,000	3 1/4	1	7/8 x 7/16	08301-25-16	24.00
8	3.00	Forged Steel	5,000	3 1/4	1 1/4	7/8 x 7/16	08301-25-20	24.00
8	4.00	Forged Steel	8,400	4 1/4	1 1/4	1-3/4 x 7/8	08401-25-20	30.00
8	4.00	Forged Steel	8,400	4 1/4	1 1/2	1-3/4 x 7/8	08401-25-24	30.00
10	3.00	Cast Iron	3,000	3 1/4	1	1-3/8 x 11/16	10301-15-16	25.00
10	3.00	Cast Iron	3,000	3 1/4	1 1/4	1-3/8 x 11/16	10301-15-20	25.00
10	3.00	H.D. Cast Iron	3,500	3 1/4	1 1/4	1-3/8 x 11/16	10301-16-20	25.00
10	3.00	H.D. Cast Iron	3,500	3 1/4	1 1/2	1-3/8 x 11/16	10301-16-24	25.00
10	3.00	Forged Steel	5,000	3 1/4	1	1-3/8 x 11/16	10301-25-16	27.00
10	3.00	Forged Steel	5,000	3 1/4	1 1/4	1-3/8 x 11/16	10301-25-20	27.00
10	3.00	H.D. Forged Steel	6,000	3 1/4	1 1/4	1-3/8 x 11/16	10301-26-20	27.00
10	3.00	H.D. Forged Steel	6,000	3 1/4	1 1/2	1-3/8 x 11/16	10301-26-24	27.00
10	4.00	Forged Steel	8,400	4 1/4	1 1/4	1-3/4 x 7/8	10401-25-20	48.00
10	4.00	Forged Steel	8,400	4 1/4	1 1/2	1-3/4 x 7/8	10401-25-24	48.00
12	5.00	H.D. Cast Iron	9,500	5 1/4	1 1/4	2 x 1	12501-16-20*	110.00
12	5.00	H.D. Cast Iron	9,500	5 1/4	1 1/2	2 x 1	12501-16-24*	110.00

Capacity listed is for manual operation.

For powered operations, consult factory.

^ Dimensions for tapered bearing bore.

* These wheels are ductile iron.

All dimensions are in inches. All weights are in pounds.

CONTINUED

WHEELS V-GROOVE

PRECISION TAPERED BEARING

Diameter	Width	Material	Capacity	Hub Length	Bore	Width x Depth	Part Number	Weight
6	2.50	Cast Iron	2,500	3 1/2	3/4	7/8 x 7/16	06259-15-12	10.00
6	3.00	Forged Steel	10,000	3 1/2	1	1-3/8 x 11/16	06309-25-16	20.00
6	3.00	Forged Steel	10,000	3 1/2	1 1/4	1-3/8 x 11/16	06309-25-20	20.00
6	3.00	H.D. Forged Steel	15,000	3 1/2	1 1/4	1-3/8 x 11/16	06309-26-20	20.00
6	3.00	H.D. Forged Steel	15,000	3 1/2	1 1/2	1-3/8 x 11/16	06309-26-24	20.00
8	2.50	Cast Iron	2,500	3 1/2	3/4	7/8 x 7/16	08259-15-12	20.00
8	3.00	Cast Iron	4,000	3 1/2	1	7/8 x 7/16	08309-15-16	22.00
8	3.00	Cast Iron	4,000	3 1/2	1 1/4	7/8 x 7/16	08309-15-20	22.00
8	3.00	H.D. Cast Iron	4,500	3 1/2	1	1-3/8 x 11/16	08309-16-16	24.00
8	3.00	H.D. Cast Iron	4,500	3 1/2	1 1/4	1-3/8 x 11/16	08309-16-20	24.00
8	3.00	Forged Steel	5,000	3 1/2	3/4	7/8 x 7/16	08309-25-12	24.00
8	3.00	Forged Steel	5,000	3 1/2	1	7/8 x 7/16	08309-25-16	24.00
8	4.00	Forged Steel	10,000	4 1/2	1	1-3/4 x 7/8	08409-25-16	30.00
8	4.00	Forged Steel	10,000	4 1/2	1 1/4	1-3/4 x 7/8	08409-25-20	30.00
8	4.00	H.D. Forged Steel	15,000	4 1/2	1 1/4	1-3/4 x 7/8	08409-26-20	31.00
8	4.00	H.D. Forged Steel	15,000	4 1/2	1 1/2	1-3/4 x 7/8	08409-26-24	31.00
10	3.00	Cast Iron	3,000	3 1/2	3/4	1-3/8 x 11/16	10309-15-12	25.00
10	3.00	H.D. Cast Iron	3,500	3 1/2	1	1-3/8 x 11/16	10309-16-16	25.00
10	3.00	H.D. Cast Iron	3,500	3 1/2	1 1/4	1-3/8 x 11/16	10309-16-20	25.00
10	3.00	Forged Steel	5,000	3 1/2	3/4	1-3/8 x 11/16	10309-25-12	27.00
10	3.00	Forged Steel	5,000	3 1/2	1	1-3/8 x 11/16	10309-25-16	27.00
10	3.00	H.D. Forged Steel	6,000	3 1/2	1	1-3/8 x 11/16	10309-26-16	27.00
10	3.00	H.D. Forged Steel	6,000	3 1/2	1 1/4	1-3/8 x 11/16	10309-26-20	27.00
10	4.00	Forged Steel	10,000	4 1/2	1	1-3/4 x 7/8	10409-25-16	48.00
10	4.00	Forged Steel	10,000	4 1/2	1 1/4	1-3/4 x 7/8	10409-25-20	48.00
10	4.00	H.D. Forged Steel	15,000	4 1/2	1 1/4	1-3/4 x 7/8	10409-26-20	48.00
10	4.00	H.D. Forged Steel	15,000	4 1/2	1 1/2	1-3/4 x 7/8	10409-26-24	48.00
12	5.00	H.D. Cast Iron	12,000	5 1/2	1 1/4	2 x 1	12509-16-20*	110.00
12	5.00	H.D. Cast Iron	12,000	5 1/2	1 1/2	2 x 1	12509-16-24*	110.00

CONTINUED

WHEELS V-GROOVE

BEARINGLESS

Diameter	Width	Material	Capacity	Hub Length	Bore	Width x Depth	Part Number	Weight
4	2.00	Cast Iron	1,000	2 3/16	1 3/16	7/8 x 7/16	04200-15-19	5.00
6	2.00	Cast Iron	1,000	2 3/16	1 3/16	7/8 x 7/16	06200-15-19	5.00
6	2.50	Cast Iron	2,500	3 1/4	1 15/16	7/8 x 7/16	06250-15-31	10.00
6	3.00	Forged Steel	15,000	3 1/4	2 7/16	1-3/8 x 11/16	06300-25-39	20.00
6	3.00	H.D. Forged Steel	15,000	3 1/4	3 1/8^	1-3/8 x 11/16	06308-26-50	20.00
8	2.50	Cast Iron	2,500	3 1/4	1 15/16	7/8 x 7/16	08250-15-31	20.00
8	3.00	Cast Iron	4,000	3 1/4	1 15/16	7/8 x 7/16	08300-15-31	22.00
8	3.00	H.D. Cast Iron	4,500	3 1/4	2 7/16	1-3/8 x 11/16	08300-16-39	24.00
8	3.00	Forged Steel	5,000	3 1/4	1 15/16	7/8 x 7/16	08300-25-31	24.00
8	4.00	Forged Steel	8,400	4 1/4	2 7/16	1-3/4 x 7/8	08400-25-39	30.00
8	4.00	H.D. Forged Steel	15,000	4 1/4	3 1/8^	1-3/4 x 7/8	08408-26-50	31.00
10	3.00	Cast Iron	3,000	3 1/4	1 15/16	1-3/8 x 11/16	10300-15-31	25.00
10	3.00	H.D. Cast Iron	3,500	3 1/4	2 7/16	1-3/8 x 11/16	10300-16-39	25.00
10	3.00	Forged Steel	5,000	3 1/4	1 15/16	1-3/8 x 11/16	10300-25-31	27.00
10	3.00	H.D. Forged Steel	6,000	3 1/4	2 7/16	1-3/8 x 11/16	10300-26-39	27.00
10	4.00	Forged Steel	8,400	4 1/4	2 7/16	1-3/4 x 7/8	10400-25-39	48.00
10	4.00	H.D. Forged Steel	15,000	4 1/4	3 1/8^	1-3/4 x 7/8	10408-26-50	48.00

Capacity listed is for manual operation.
For powered operations, consult factory.

^ Dimensions for tapered bearing bore.

* These wheels are ductile iron.

All dimensions are in inches. All weights are in pounds.

WHEELS FLANGED



FEATURES

Bearings: Roller, tapered, and bearingless.

Temperature: Maximum to 800°F with proper bearing and lubrication.

Standard: All 1-1/2" and 2" width wheels with 3/4" roller bearings are supplied with 1/2" spanner bushing.

APPLICATIONS

Flanged wheels are excellent for precise alignment of work, captive turntables or repetitive processes, including foundry cooling lines.

BENEFITS

The flanged wheel is designed to operate on steel tracking to minimize guidance and rolling effort. These wheels are constructed of premium cast iron and steel for high strength and long wear.

Various bore sizes are available for use with keyway or a variety of bearings.

MAXIMUM CAPACITY

12,000 lbs.

FLANGED RAIL DIMENSIONS

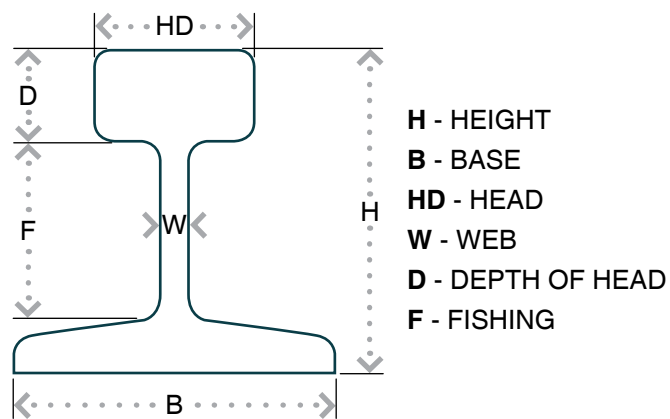

RAIL SIZES

Weight (LB/FT)	H	B	HD	W	D	F
12	2	2	1	3/16	9/16	1-1/32
16	2-3/8	2-3/8	1-11/64	7/32	41/64	1-23/64
20	2-5/8	2-5/8	1-11/32	1/4	23/32	1-15/32
25	2-3/4	2-3/4	1-1/2	19/64	25/32	1-31/64
30	3-1/8	3-1/8	1-11/16	21/64	7/8	1-23/32
40	3-1/2	3-1/2	1-7/8	25/64	1-1/64	1-55/64
60	4-1/4	4-1/4	2-3/8	31/64	1-7/32	2-17/64
80	5	5	2-1/2	35/64	1-1/2	2-5/8
85	5-3/16	5-3/16	2-9/16	9/16	1-35/64	2-3/4
90	5-5/8	5-1/8	2-9/16	9/16	1-15/32	3-5/32
100	6	5-3/8	2-11/16	9/16	1-21/32	3-9/32

WHEELS FLANGED

STRAIGHT ROLLER BEARING (SINGLE FLANGED)

Dia. A	Width B	Dia. C	Width D	Material	Capacity	Hub Length E	Bore F	Hub Dia. G	Part Number	Weight
3.50	1.31	4.50	1.69	Cast Iron	1,000	1 15/16	3/4	2 1/8	03101-18-12	5.00
4.50	2.25	5.50	3.00	Cast Iron	4,000	3 1/4	1	3 3/4	04251-18-16	15.00
4.50	2.25	5.50	3.00	Cast Iron	4,000	3 1/4	1 1/4	3 3/4	04251-18-20	15.00
5.00	2.06	6.00	2.69	Forged Steel	6,000	3 1/4	1 1/4	3 7/8	05201-28-20	15.00
5.00	2.06	6.00	2.69	Forged Steel	6,000	3 1/4	1 1/2	3 7/8	05201-28-24	15.00
6.00	1.63	6.75	2.00	Cast Iron	900	2 3/16	3/4	1 3/4	06151-18-12	18.00
6.00	2.00	7.00	2.75	Cast Iron	3,500	3 1/4	1	3	06251-18-16	20.50
6.00	2.00	7.00	2.75	Cast Iron	3,500	3 1/4	1 1/4	3	06251-18-20	20.50
6.13	1.69	7.00	2.13	Cast Iron	4,000	2 3/4	1 1/4	3	06201-18-20	24.00
7.87	2.25	9.25	2.75	Cast Iron	3,500	3 1/4	1 1/4	3 3/4	07251-18-20	29.00
7.87	2.25	9.25	2.75	Cast Iron	3,500	3 1/4	1 1/2	3 3/4	07251-18-24	29.00
7.87	1.75	8.63	2.25	Cast Iron	3,000	2 1/2	3/4	2 7/8	08201-18-12	27.00
7.87	1.75	8.63	2.25	Cast Iron	3,000	2 1/2	1	2 7/8	08201-18-16	27.00
7.87	1.75	8.63	2.25	Cast Iron	3,000	2 1/2	1 1/4	2 7/8	08201-18-20	27.00
8.00	2.38	9.00	3.00	Forged Steel	6,000	3 1/4	1 1/4	5	08201-28-20	48.00
8.00	2.38	9.00	3.00	Forged Steel	6,000	3 1/4	1 1/2	5	08201-28-24	48.00
8.00	2.25	9.50	3.00	Cast Iron	3,500	3 1/4	1 1/4	3 3/4	08251-18-20	33.00
8.00	2.20	9.50	3.00	Cast Iron	3,500	3 1/4	1 1/2	3 3/4	08251-18-24	33.00
14.88	2.56	16.88	3.38	Cast Iron	8,000	4 1/4	1 1/4	4 1/2	15251-18-20	100.00
14.88	2.56	16.88	3.38	Cast Iron	8,000	4 1/4	1 1/2	4 1/2	15251-18-24	100.00

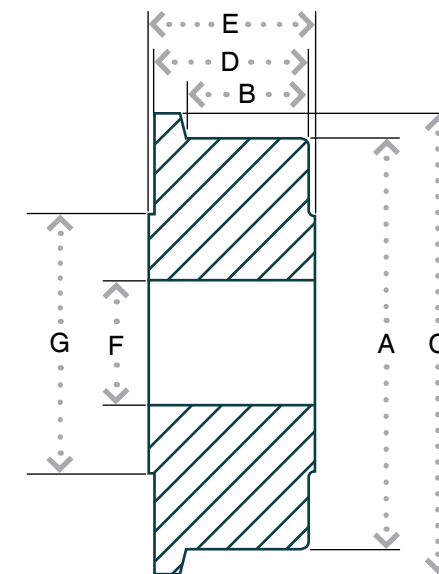

CONTINUED

All dimensions are in inches. All weights are in pounds.

WHEELS FLANGED

PRECISION TAPERED BEARING (SINGLE FLANGED)

Dia. A	Width B	Dia. C	Width D	Material	Capacity	Hub Length E	Bore F	Hub Dia. G	Part Number	Weight
4.00	2.00	5.25	3.00	Cast Iron	5,000	3 1/2	1	2 1/2	04209-18-16	10.00
4.50	2.25	5.50	3.00	Cast Iron	5,000	3 1/2	1	3 3/4	04259-18-16	15.00
4.50	2.25	5.50	3.00	Cast Iron	5,000	3 1/2	1 1/4	3 3/4	04259-18-20	15.00
5.00	2.06	6.00	2.69	Forged Steel	10,000	3 1/2	1	3 7/8	05209-28-16	15.00
5.00	2.06	6.00	2.69	Forged Steel	10,000	3 1/2	1 1/4	3 7/8	05209-28-20	15.00
6.13	1.69	7.00	2.13	Cast Iron	5,000	3	3/4	3	06209-18-12	24.00
6.13	1.69	7.00	2.13	Cast Iron	5,000	3	1	3	06209-18-16	24.00
6.00	2.00	7.00	2.75	Cast Iron	3,500	3 1/2	3/4	3	06259-18-12	20.50
6.00	2.00	7.00	2.75	Cast Iron	3,500	3 1/2	1	3	06259-18-16	20.50
7.87	2.25	9.25	2.75	Cast Iron	3,500	3 1/2	1	3 3/4	07259-18-16	29.00
7.87	2.25	9.25	2.75	Cast Iron	3,500	3 1/2	1 1/4	3 3/4	07259-18-20	29.00
7.87	1.75	8.63	2.25	Cast Iron	3,000	2 3/4	3/4	2 7/8	08209-18-12	27.00
8.00	2.38	9.00	3.00	Forged Steel	10,000	3 1/2	1	5	08209-28-16	48.00
8.00	2.38	9.00	3.00	Forged Steel	10,000	3 1/2	1 1/4	5	08209-28-20	48.00
8.00	2.25	9.50	3.00	Cast Iron	3,500	3 1/2	1	3 3/4	08259-18-16	33.00
8.00	2.25	9.50	3.00	Cast Iron	3,500	3 1/2	1 1/4	3 3/4	08259-18-20	33.00
10.00	4.00	12.00	5.00	Cast Iron	12,000	6 1/4	1 1/4	4 1/2	10409-18-20	90.00
10.00	4.00	12.00	5.00	Cast Iron	12,000	6 1/4	1 1/2	4 1/2	10409-18-24	90.00
14.88	2.56	16.88	3.38	Cast Iron	8,000	4 1/2	1	4 1/2	15259-18-16	100.00
14.88	2.56	16.88	3.38	Cast Iron	8,000	4 1/2	1 1/4	4 1/2	15259-18-20	100.00

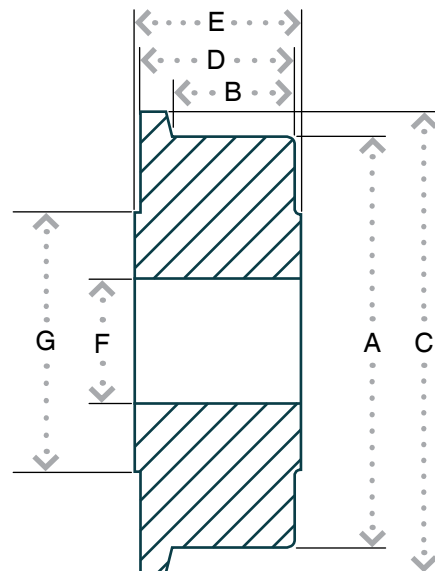

CONTINUED

WHEELS FLANGED

BEARINGLESS (SINGLE FLANGED)

Dia. A	Width B	Dia. C	Width D	Material	Capacity	Hub Length E	Bore F	Hub Dia. G	Part Number	Weight
3.50	1.31	4.50	1.69	Cast Iron	1,000	1 15/16	1 3/16	2 1/8	03100-18-19	5.00
4.50	2.25	5.50	3.00	Cast Iron	5,000	3 1/4	2 7/16	2 1/2	04258-18-39	15.00
4.50	2.25	5.50	3.00	Cast Iron	5,000	3 1/4	1 15/16	3 3/4	04250-18-31	15.00
5.00	2.06	6.00	2.69	Forged Steel	10,000	3 1/4	2 7/16	3 7/8	05208-28-39	15.00
6.00	1.63	6.75	2.00	Cast Iron	900	2 3/16	1 3/16	1 3/4	06150-18-19	18.00
6.00	2.00	7.00	2.75	Cast Iron	3,500	3 1/4	1 15/16	3	06250-18-31	20.50
6.13	1.69	7.00	2.13	Cast Iron	5,000	2 3/4	1 15/16	3	06200-18-31	24.00
7.87	2.25	9.25	2.75	Cast Iron	3,500	3 1/4	2 7/16	3 3/4	07250-18-39	29.00
7.87	1.75	8.63	2.25	Cast Iron	3,000	2 1/2	1 3/16	2 7/8	08200-18-19	27.00
7.87	1.75	8.63	2.25	Cast Iron	3,000	2 1/2	1 15/16	2 7/8	08200-18-31	27.00
8.00	2.38	9.00	3.00	Forged Steel	15,000	3 1/4	2 7/16	5	08200-28-39	48.00
8.00	2.25	9.50	3.00	Cast Iron	3,500	3 1/4	2 7/16	3 3/4	08250-18-39	33.00
10.00	4.00	12.00	5.00	Cast Iron	12,000	6	3 1/8	4 1/2	10408-18-50	90.00
14.88	2.56	16.88	3.38	Cast Iron	8,000	4 1/4	2 7/16	4 1/2	15250-18-39	100.00

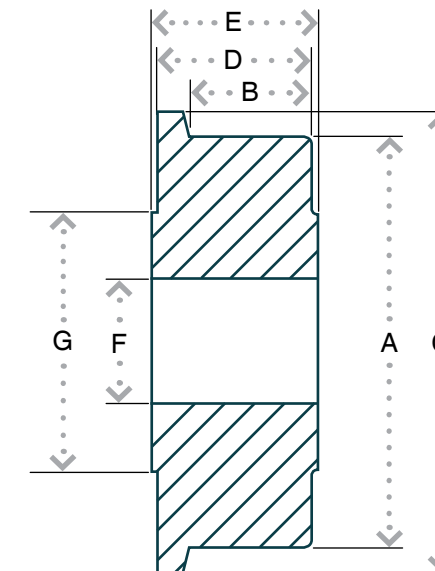

CONTINUED

All dimensions are in inches. All weights are in pounds.

WHEELS FLANGED

STRAIGHT ROLLER BEARING (DUAL FLANGED)

Dia. A	Width B	Dia. C	Width D	Material	Capacity	Hub Length E	Bore F	Hub Dia. G	Part Number	Weight
5.00	1.69	6.00	3.00	Forged Steel	6,000	3 1/4	1 1/4	3 7/8	05201-29-20	17.00
5.00	1.69	6.00	3.00	Forged Steel	6,000	3 1/4	1 1/2	3 7/8	05201-29-24	17.00
6.00	2.13	7.25	3.00	Cast Iron	5,000	3 1/4	1	3	06201-19-16	26.00
6.00	2.13	7.25	3.00	Cast Iron	5,000	3 1/4	1 1/4	3	06201-19-20	26.00
8.00	1.76	9.00	3.00	Forged Steel	6,000	3 1/4	1 1/4	5	08201-29-20	50.00
8.00	1.76	9.00	3.00	Forged Steel	6,000	3 1/4	1 1/2	5	08201-29-24	50.00

PRECISION TAPERED BEARING (DUAL FLANGED)

Dia. A	Width B	Dia. C	Width D	Material	Capacity	Hub Length E	Bore F	Hub Dia. G	Part Number	Weight
5.00	1.69	6.00	3.00	Forged Steel	10,000	3 1/2	1	3 7/8	05209-29-16	17.00
5.00	1.69	6.00	3.00	Forged Steel	10,000	3 1/2	1 1/4	3 7/8	05209-29-20	17.00
6.00	2.13	7.25	3.00	Cast Iron	5,000	3 1/2	3/4	3	06209-19-12	26.00
6.00	2.13	7.25	3.00	Cast Iron	6,000	3 1/2	1	3	06209-19-16	26.00
8.00	1.76	9.00	3.00	Forged Steel	10,000	3 1/2	1	5	08209-29-16	50.00
8.00	1.76	9.00	3.00	Forged Steel	10,000	3 1/2	1 1/4	5	08209-29-20	50.00
10.00	3.00	12.00	5.00	Cast Iron	12,000	6 1/4	1 1/4	4 1/2	10309-19-20	95.00
10.00	3.00	12.00	5.00	Cast Iron	12,000	6 1/4	1 1/2	4 1/2	10309-19-24	95.00

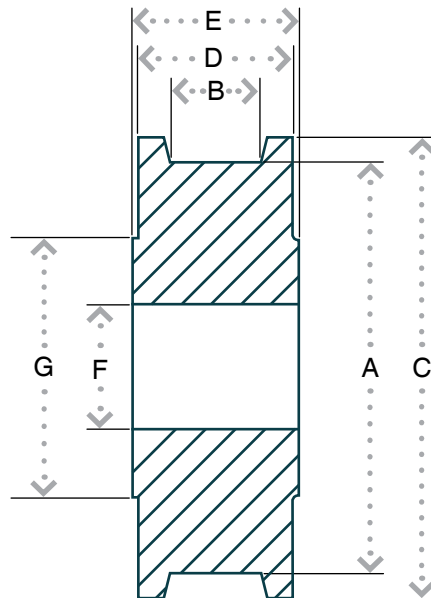

CONTINUED

WHEELS FLANGED

BEARINGLESS (DUAL FLANGED)

Dia. A	Width B	Dia. C	Width D	Material	Capacity	Hub Length E	Bore F	Hub Dia. G	Part Number	Weight
5.00	1.69	6.00	3.00	Forged Steel	10,000	3 1/4	2 7/16	3 7/8	05200-29-39	17.00
6.00	2.13	7.25	3.00	Cast Iron	6,000	3 1/4	1 15/16	3	06200-19-31	26.00
8.00	1.76	9.00	3.00	Forged Steel	15,000	3 1/4	2 7/16	5	08200-29-39	50.00
8.00	1.76	9.00	3.00	Forged Steel	15,000	3 1/4	2 7/16	5	08208-29-39	50.00
10.00	3.00	12.00	5.00	Cast Iron	12,000	6	3 1/8	4 1/2	10308-19-50	95.00

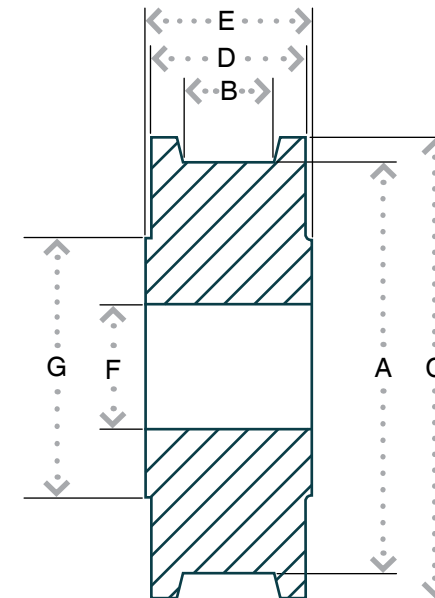

All dimensions are in inches. All weights are in pounds.

WHEELS FORGED STEEL



MAXIMUM CAPACITY

20,000 lbs.

FEATURES

Bearings: Roller, tapered, bearingless, teflon.

Temperature: Maximum to 800 degrees with proper bearings and lubrication.

Standard: All 1-1/2" and 2" wide wheels are supplied with 1/2" spanner standard.

BENEFITS

Forged steel wheels are hot forged from high carbon steel billets heated to 2,400 degrees Fahrenheit then repeatedly hit by high tonnage forging hammers. This process enhances the grain structure and increases the ductility and tensile strength (64,000 psi) of the wheel. The wheels are then precision machined flat with rounded edges to finished tolerances.

Forged steel wheels offer the greatest load capacity, impact strength and rollability of all caster wheels.

Wheel material codes: forged steel (20); heavy-duty forged steel (21); ductile iron (12).

WHEELS FORGED STEEL

STRAIGHT ROLLER BEARING

Diameter	Width	Capacity	Hub Length	Bore	Part Number	Weight
4	1.50	1,400	2 3/16	3/4	04101-20-12	3.25
5	1.75	1,500	2 3/16	3/4	05201-20-12	5.25
6	2.00	1,500	2 3/16	3/4	06201-20-12	6.25
6	2.50	4,000	3 1/4	1 1/4	06251-20-20	12.00
6	2.50	4,000	3 1/4	1	06251-20-16	12.00
6	3.00	6,000	3 1/4	1 1/4	06301-20-20	20.00
6	3.00	6,000	3 1/4	1 1/2	06301-20-24	20.00
8	2.50	4,000	3 1/4	1	08251-20-16	12.00
8	2.50	4,000	3 1/4	1 1/4	08251-20-20	12.00
8	3.00	4,500	3 1/4	1	08301-20-16	18.50
8	3.00	4,500	3 1/4	1 1/4	08301-20-20	18.50
8	4.00	8,400	4 1/4	1 1/4	08401-20-20	37.00
8	4.00	8,400	4 1/4	1 1/2	08401-20-24	37.00
10	3.00	5,000	3 1/4	1	10301-20-16	28.00
10	3.00	5,000	3 1/4	1 1/4	10301-20-20	28.00
10	3.00	6,000	3 1/4	1 1/4	10301-21-20	28.00
10	3.00	6,000	3 1/4	1 1/2	10301-21-24	28.00
10	4.00	8,400	4 1/4	1 1/4	10401-20-20	48.00
10	4.00	8,400	4 1/4	1 1/2	10401-20-24	48.00
12	4.00	7,500	4 1/4	1 1/4	12401-12-20*	53.00
12	4.00	7,500	4 1/4	1 1/2	12401-12-24*	53.00
12	5.00	10,000	5 1/4	1 1/4	12501-12-20*	98.00
12	5.00	10,000	5 1/4	1 1/2	12401-12-24*	98.00

[^] Dimensions for tapered bearing bore.

* These wheels are cast ductile iron.

All dimensions are in inches. All weights are in pounds.

CONTINUED

WHEELS FORGED STEEL

PRECISION TAPERED BEARING

Diameter	Width	Capacity	Hub Length	Bore	Part Number	Weight
4	1.50	1,400	2 7/16	1/2	04109-20-08	3.25
5	1.75	1,800	2 7/16	1/2	05209-20-08	5.25
6	2.00	2,500	2 7/16	1/2	06209-20-08	6.25
6	2.50	5,000	3 1/2	3/4	06259-20-12	12.00
6	2.50	5,000	3 1/2	1	06259-20-16	12.00
6	3.00	10,000	3 1/2	1 1/4	06309-20-20	21.00
6	3.00	10,000	3 1/2	1	06309-20-16	21.00
6	3.00	17,000	3 1/2	1 1/4	06309-21-20	22.00
6	3.00	17,000	3 1/2	1 1/2	06309-21-24	22.00
8	2.50	5,000	3 1/2	3/4	08259-20-12	12.00
8	3.00	5,500	3 1/2	3/4	08309-20-12	18.50
8	3.00	5,500	3 1/2	1	08309-20-16	18.50
8	4.00	10,000	4 1/2	1	08409-20-16	37.00
8	4.00	10,000	4 1/2	1 1/4	08409-20-20	37.00
8	4.00	20,000	4 1/2	1 1/4	08409-21-20	37.00
8	4.00	20,000	4 1/2	1 1/2	08409-21-24	37.00
10	3.00	6,000	3 1/2	3/4	10309-20-12	28.00
10	3.00	6,000	3 1/2	1	10309-20-16	28.00
10	3.00	6,500	3 1/2	1	10309-21-16	28.00
10	3.00	6,500	3 1/2	1 1/4	10309-21-20	28.00
10	4.00	10,000	4 1/2	1	10409-20-16	48.00
10	4.00	10,000	4 1/2	1 1/4	10409-20-20	48.00
10	4.00	20,000	4 1/2	1 1/4	10409-21-20	48.00
10	4.00	20,000	4 1/2	1 1/2	10409-21-24	48.00
12	4.00	7,500	4 1/2	1	12409-12-16*	53.00
12	4.00	7,500	4 1/2	1 1/4	12409-12-20*	53.00
12	5.00	10,000	5 1/2	1 1/4	12509-12-20*	98.00
12	5.00	10,000	5 1/2	1 1/2	12509-12-24*	98.00

CONTINUED

WHEELS FORGED STEEL

BEARINGLESS

Diameter	Width	Capacity	Hub Length	Bore	Part Number	Weight
4	1.50	1,400	2 3/16	1 3/16	04100-20-19	3.25
5	1.75	1,500	2 3/16	1 3/16	05200-20-19	5.25
6	2.00	1,500	2 3/16	1 3/16	06200-20-19	6.25
6	2.50	4,000	3 1/4	1 15/16	06250-20-31	12.00
6	3.00	6,000	3 1/4	2 7/16	06300-20-39	20.00
6	3.00	17,000	3 1/4	3 1/8^	06308-21-50	22.00
8	2.50	4,000	3 1/4	1 15/16	08250-20-31	12.00
8	3.00	4,500	3 1/4	1 15/16	08300-20-31	18.50
8	4.00	8,400	4 1/4	2 7/16	08400-20-39	37.00
8	4.00	20,000	4 1/4	3 1/8^	08408-21-50^	37.00
10	3.00	5,000	3 1/4	1 15/16	10300-20-31	28.00
10	3.00	6,000	3 1/4	2 7/16	10300-21-39	28.00
10	4.00	8,400	4 1/4	2 7/16	10400-20-39	48.00
10	4.00	20,000	4 1/4	3 1/8^	10408-21-50	48.00
12	4.00	7,500	4 1/4	2 7/16	12400-12-39*	53.00

^ Dimensions for tapered bearing bore.

* These wheels are cast ductile iron.

All dimensions are in inches. All weights are in pounds.

WHEELS CAST IRON



MAXIMUM CAPACITY

15,000 lbs.

FEATURES

Standard: All 1-1/2" and 2" wide wheels with 3/4" roller bearings are supplied with 1/2" spanner standard.

BENEFITS

These cast iron wheels are constructed of premium Class 30 gray iron for maximum load capacity and impact strength. The wheels feature heavy cross section castings for heavy duty use, abrasion resistance and a long service life. Each wheel is precision machined with rounded edges to finished tolerances.

Built for high capacity applications, the cast iron wheels can withstand extreme heat. Precision tapered bearings are available to complement the characteristics of the wheels.

Wheel material codes: cast iron (10); heavy-duty cast iron (11); ductile iron (12).

WHEELS CAST IRON

STRAIGHT ROLLER BEARING

Diameter	Width	Capacity	Hub Length	Bore	Part Number	Weight
3.25	1.50	400	1 5/8	3/4	03151-10-12	3.40
3.25	1.50	400	1 5/8	5/8	03151-10-10	3.40
3.25	2.00	700	2 3/16	3/4	03201-10-12	3.40
4	1.50	600	1 5/8	5/8	04151-10-10	3.40
4	2.00	1,000	2 3/16	3/4	04201-10-12	4.00
4	3.00	2,000	3 1/4	1	04301-10-16	7.00
4	3.00	2,000	3 1/4	1 1/4	04301-10-20	7.00
4	4.00	4,000	4 1/4	1 1/4	04401-10-20	11.00
5	1.50	600	1 5/8	3/4	05151-10-12	
5	1.50	600	1 5/8	5/8	05151-10-10	
5	2.00	1,200	2 3/16	3/4	05201-10-12	6.00
5	2.00	1,200	2 3/16	5/8	05201-10-10	
5	2.50	2,000	3 1/4	1	05251-10-16	7.50
5	2.50	2,000	3 1/4	1 1/4	05251-10-20	7.50
6	1.50	800	1 5/8	3/4	06151-10-12	
6	1.50	800	1 5/8	5/8	06151-10-10	
6	2.00	1,300	2 3/16	3/4	06201-10-12	6.80
6	2.50	2,500	3 1/4	1 1/4	06251-10-20	12.00
6	2.50	2,500	3 1/4	1	06251-10-16	12.00
6	3.00	2,500	3 1/4	1	06301-10-16	12.00
6	3.00	2,500	3 1/4	1 1/4	06301-10-20	12.00
7	3.00	4,000	3 1/4	1	07301-10-16	27.00
7	3.00	4,000	3 1/4	1 1/4	07301-10-20	27.00
7	3.00	6,000	3 1/4	1 1/4	07301-11-20	27.00
7	3.00	6,000	3 1/4	1 1/2	07301-11-24	27.00
8	2.00	1,500	2 3/16	3/4	08201-10-12	7.50
8	2.00	1,500	2 3/16	5/8	08201-10-10	7.50
8	3.00	3,500	3 1/4	1	08301-10-16	15.00
8	3.00	3,500	3 1/4	1 1/4	08301-10-20	15.00
8	3.00	4,500	3 1/4	1 1/4	08301-11-20	25.00
8	4.00	5,000	4 1/4	1 1/4	08401-10-20	28.00
10	3.00	3,500	3 1/4	1	10301-10-16	30.00
10	3.00	3,500	3 1/4	1 1/4	10301-10-20	30.00
10	3.00	4,000	3 1/4	1 1/4	10301-11-20	30.00
10	3.00	4,000	3 1/4	1 1/2	10301-11-24	30.00
10	4.00	6,000	4 1/4	1 1/4	10401-10-20	32.00

Capacity listed is for manual operation. For powered operations, consult factory.
* These wheels are cast ductile iron. All dimensions are in inches. All weights are in pounds.

CONTINUED

WHEELS CAST IRON

STRAIGHT ROLLER BEARING

Diameter	Width	Capacity	Hub Length	Bore	Part Number	Weight
12	2.50	2,500	3 1/4	1	12251-10-16	37.00
12	2.50	2,500	3 1/4	1 1/4	12251-10-20	37.00
12	3.00	3,000	3 1/4	1	12301-10-16	39.00
12	3.00	3,000	3 1/4	1 1/4	12301-10-20	39.00
12	4.00	7,500	4 1/4	1 1/4	12401-12-20*	53.00
12	4.00	7,500	4 1/4	1 1/2	12401-12-24*	53.00
12	5.00	10,000	5 1/4	1 1/4	12501-12-20*	98.00
12	5.00	10,000	5 1/4	1 1/2	12501-12-24*	98.00
14	4.00	7,000	4 1/4	1 1/4	14401-10-20	60.00
16	3.00	3,000	3 1/4	1	16301-10-16	64.00
16	3.00	3,000	3 1/4	1 1/4	16301-10-20	64.00
16	4.00	7,500	4 1/4	1 1/4	16401-10-20	72.00
16	4.00	7,500	4 1/4	1 1/2	16401-10-24	72.00

PRECISION TAPERED BEARING

Diameter	Width	Capacity	Hub Length	Bore	Part Number	Weight
4	3.00	2,000	3 1/2	3/4	04309-10-12	7.00
4	4.00	4,000	4 1/2	1	04409-10-16	11.00
4	4.00	4,000	4 1/2	1 1/4	04409-10-20	11.00
5	2.50	2,000	3 1/2	3/4	05259-10-12	7.50
6	2.50	2,500	3 1/2	3/4	06259-10-12	12.00
6	2.50	2,500	3 1/2	1	06259-10-16	12.00
6	3.00	2,500	3 1/2	3/4	06309-10-12	12.00
6	3.00	2,500	3 1/2	1	06309-10-16	12.00
7	3.00	4,000	3 1/2	3/4	07309-10-12	27.00
7	3.00	6,000	3 1/2	1	07309-11-16	27.00
7	3.00	6,000	3 1/2	1 1/4	07309-11-20	27.00
8	3.00	4,500	3 1/2	3/4	08309-10-12	15.00
8	3.00	4,500	3 1/2	1	08309-11-16	25.00
8	3.00	4,500	3 1/2	1 1/4	08309-11-20	25.00
8	4.00	5,000	4 1/2	1	08409-10-16	28.00
8	4.00	5,000	4 1/2	1 1/4	08409-10-20	28.00

CONTINUED

WHEELS CAST IRON

PRECISION TAPERED BEARING

Diameter	Width	Capacity	Hub Length	Bore	Part Number	Weight
10	3.00	3,500	3 1/2	3/4	10309-10-12	30.00
10	3.00	3,500	3 1/2	1	10309-10-16	30.00
10	3.00	4,000	3 1/2	1	10309-11-16	30.00
10	3.00	4,000	3 1/2	1 1/4	10309-11-20	30.00
10	4.00	6,000	4 1/2	1	10409-10-16	32.00
10	4.00	6,000	4 1/2	1 1/4	10409-10-20	32.00
12	3.00	3,000	3 1/2	3/4	12309-10-12	39.00
12	3.00	3,000	3 1/2	1	12309-10-16	39.00
12	4.00	7,500	4 1/2	1	12409-12-16*	53.00
12	4.00	7,500	4 1/2	1 1/4	12409-12-20*	53.00
12	5.00	15,000	5 1/2	1 1/4	12509-12-20*	98.00
12	5.00	15,000	5 1/2	1 1/2	12509-12-24*	98.00
12	6.00	10,000	6 1/2	1 1/4	12609-10-20	75.00
12	6.00	10,000	6 1/2	1 1/2	12609-10-24	75.00
14	4.00	7,000	4 1/2	1	14409-10-16	60.00
14	4.00	7,000	4 1/2	1 1/4	14409-10-20	60.00
16	3.00	3,000	3 1/2	1	16309-10-16	64.00
16	4.00	7,500	4 1/2	1	16409-10-16	72.00
16	4.00	7,500	4 1/2	1 1/4	16409-10-20	72.00
16	4.00	7,500	4 1/2	1 1/2	16409-10-24	72.00

BEARINGLESS

Diameter	Width	Capacity	Hub Length	Bore	Part Number	Weight
3	1.25	450	1 1/2	3/8	03120-10-06	2.00
4	1.50	600	1 11/16	1/2	04150-10-08	3.40
4	2.00	1,000	2 3/16	1 3/16	04200-10-19	4.00
4	3.00	2,000	3 1/4	1 15/16	04300-10-31	7.00
4	4.00	4,000	4 1/4	2 7/16	04400-10-39	11.00
5	2.00	1,500	2 3/16	1 3/16	05200-10-19	6.00
5	2.50	2,000	3 1/4	1 15/16	05250-10-31	7.50
6	2.00	1,300	2 3/16	1 3/16	06200-10-19	6.80
6	2.50	2,500	3 1/4	1 15/16	06250-10-31	12.00
6	3.00	2,500	3 1/4	1 15/16	06300-10-31	12.00
7	3.00	4,000	3 1/4	1 15/16	07300-10-31	27.00
7	3.00	6,000	3 1/4	2 7/16	07300-11-39	27.00

Capacity listed is for manual operation. For powered operations, consult factory.
* These wheels are cast ductile iron. All dimensions are in inches. All weights are in pounds.

CONTINUED

WHEELS CAST IRON

BEARINGLESS

Diameter	Width	Capacity	Hub Length	Bore	Part Number	Weight
8	2.00	1,500	2 3/16	1 3/16	08200-10-19	7.50
8	3.00	3,500	3 1/4	1 15/16	08300-10-31	15.00
8	4.00	5,000	4 1/4	2 7/16	08400-10-39	28.00
10	3.00	3,500	3 1/4	1 15/16	10300-10-31	30.00
10	3.00	4,000	3 1/4	2 7/16	10300-11-39	30.00
10	4.00	6,000	4 1/4	2 7/16	10400-10-39	32.00
12	4.00	7,500	4 1/4	2 7/16	12400-12-39*	53.00
14	4.00	7,000	4 1/4	2 7/16	14400-10-39	60.00
16	4.00	7,500	4 1/4	2 7/16	16400-10-39	72.00

Capacity listed is for manual operation. For powered operations, consult factory.
* These wheels are cast ductile iron. All dimensions are in inches. All weights are in pounds.



WHEELS PHENOLIC RESIN

WHEELS PHENOLIC RESIN



MAXIMUM CAPACITY

8,000 lbs.

FEATURES

Bearings: Precision ball, delrin, straight roller and tapered.

Standard: All 1-1/2" and 2" wide wheels with 3/4" roller bearings are supplied with 1/2" spanner standard.

APPLICATIONS

Phenolic wheels are excellent for waste bins, platform trucks, heavy material handling, autoclaves, baking ovens, curing ovens and high temperature bakery applications.

BENEFITS

A wide selection of phenolic resin wheels are available in inventory. The wheels shown in the chart are laminated phenolic. The continuous wrap process of a phenolic wheel makes it longer wearing product that has a higher resistance to chipping and fraying.

Standard black phenolic wheels (30) feature macerated canvas duck compression molded with premium phenolic resins to produce a value/price relationship.

High temperature phenolic wheels (32) provide continuous service up to 425° Fahrenheit and intermittently to 500° Fahrenheit.

Laminated phenolic wheels (35) feature a continuous wound tread with a macerated canvas center. The wheels have a 40% higher impact resistance and carry up to 25% higher load than standard phenolic wheels.

WHEELS PHENOLIC RESIN

STRAIGHT ROLLER BEARING

Diameter	Width	Standard Capacity	Laminated Capacity	High Temp Capacity	Hub Length	Bore	Part Number	Weight
5	2.00	1,000	1,200	750	2 3/16	3/4	05201-30-12	2.25
6	2.00	1,200	1,500	900	2 3/16	3/4	06201-30-12	3.00
6	3.00	2,000	2,000	1,700	3 1/4	1	06301-30-16	5.00
6	3.00	2,000	2,000	1,700	3 1/4	1 1/4	06301-30-20	5.00
8	2.00	1,400	1,400	1,100	2 3/16	3/4	08201-30-12	4.00
8	3.00	2,500	3,000	1,900	3 1/4	1	08301-30-16	7.00
8	3.00	2,500	3,000	1,900	3 1/4	1 1/4	08301-30-20	7.00
10	3.00	2,900	3,400	2,400	3 1/4	1	10301-30-16	9.75
10	3.00	2,900	3,400	2,400	3 1/4	1 1/4	10301-30-20	9.75
12	3.00	3,500	4,200	2,600	3 1/4	1	12301-30-16	13.00
12	3.00	3,500	4,200	2,600	3 1/4	1 1/4	12301-30-20	13.00

PRECISION TAPERED BEARING

Diameter	Width	Standard Capacity	Laminated Capacity	High Temp Capacity	Hub Length	Bore	Part Number	Weight
6	3.00	2,000	2,000	1,700	3 1/2	3/4	06309-30-12	5.00
6	3.00	2,000	2,000	1,700	3 1/2	1	06309-30-16	5.00
8	3.00	2,500	3,000	1,900	3 1/2	3/4	08309-30-12	7.00
8	3.00	2,500	3,000	1,900	3 1/2	1	08309-30-16	7.00
10	3.00	2,900	3,400	2,400	3 1/2	3/4	10309-30-12	9.75
10	3.00	2,900	3,400	2,400	3 1/2	1	10309-30-16	9.75
10	3.00	2,900	3,400	2,400	3 1/2	1 1/4	10309-30-20	9.75
12	3.00	3,500	4,200	2,600	3 1/2	3/4	12309-30-12	13.00

PRECISION BEARING

Diameter	Width	Standard Capacity	Laminated Capacity	High Temp Capacity	Hub Length	Bore	Part Number	Weight
5	2.00	1,000	1,200	750	2 7/16	1/2	05204-30-08*	2.25
6	2.00	1,200	1,500	900	2 7/16	1/2	06204-30-08*	3.00
6	3.00	2,000	2,000	1,700	3 1/2	3/4	06302-30-12	5.00
8	2.00	1,400	1,400	1,100	2 7/16	1/2	08204-30-08*	4.00
8	3.00	2,500	3,000	1,900	3 1/2	3/4	08302-30-12	7.00
10	3.00	2,900	3,400	2,400	3 1/2	3/4	10302-30-12	9.75
12	3.00	3,500	4,200	2,600	3 1/2	3/4	12302-30-12	13.00

All dimensions are in inches. All weights are in pounds.

* These casters have annular ball bearings.

Note: part numbers listed are for Standard Phenolic wheels, for High Temp use "32" in place of "30" and for Laminated Phenolic use "35" in place of "30"

WHEELS TWERGO®



MAXIMUM CAPACITY

4,200 lbs.

FEATURES

TWERGO® wheels are designed to achieve unparalleled ergonomic benefits, including reduced initial and continuous push force, and a reduction in force required to turn and maneuver. Furthermore, TWERGO® wheels can help increase productivity by reducing or maintaining existing push force, while increasing the load capacity.

TWERGO® wheel's unique tread thickness and twin wheel design minimizes friction and eliminates scrubbing and sliding when turning, while providing the impact resistance of normal wheels. These features give TWERGO® wheels superior performance in reducing ergonomic forces in manual operations and reducing power consumption in automated applications.

The multiple wheel design is anchored by a robust spanner that improves on existing wheel designs. The wheel hub features aluminum die-cast cores for maximum strength.

APPLICATIONS

Excellent in any inside applications where ergonomics are a concern. Used in AGV applications to extend wheel life and reduce power consumption.

Designed for a wide variety of industrial applications, TWERGO® wheels provide easier movement of loaded carts or vehicles.

BENEFITS

Benefits of TWERGO® include:

- Reduce Initial push force by an average of 25%.
- Independently rotating wheels reduce scrubbing and push force exerted to turn and maneuver.
- Aluminum core is lighter weight and resists corrosion.
- Increase load and productivity without increasing push force.

For optimal ergonomic benefit, we recommend using TWERGO® wheels on our ErgoXcel™ line of kingpinless, maintenance-free ergonomic rigs, including the 37, 55, 57 and 87 Series.

WHEELS TWERGO®

PRECISION BALL BEARING (2 WHEEL DESIGN - 2" WIDTH)

Diameter	Width	Material	Capacity	Hub Length	Bore	Part Number	Weight
4	2.00	T/R Polyurethane	600	2 7/16	1/2	04202-93-08	1.77
4	2.00	T/R-95 Polyurethane	1,000	2 7/16	1/2	04202-94-08	1.77
4	2.00	ErgoTread	570	2 7/16	1/2	04202-44-08	1.77
5	2.00	T/R Polyurethane	840	2 7/16	1/2	05202-93-08	2.73
5	2.00	T/R-95 Polyurethane	1,170	2 7/16	1/2	05202-94-08	2.73
5	2.00	ErgoTread	800	2 7/16	1/2	05202-44-08	2.73
6	2.00	T/R Polyurethane	960	2 7/16	1/2	06202-93-08	3.12
6	2.00	T/R-95 Polyurethane	1,400	2 7/16	1/2	06202-94-08	3.12
6	2.00	ErgoTread	910	2 7/16	1/2	06202-44-08	3.12
8	2.00	T/R Polyurethane	1,240	2 7/16	1/2	08202-93-08	4.65
8	2.00	T/R-95 Polyurethane	1,800	2 7/16	1/2	08202-94-08	4.65
8	2.00	ErgoTread	1,180	2 7/16	1/2	08202-44-08	4.65
10	2.00	T/R Polyurethane	1,600	2 7/16	1/2	10202-93-08	6.06
10	2.00	T/R-95 Polyurethane	2,500	2 7/16	1/2	10202-94-08	6.06
10	2.00	ErgoTread	1,520	2 7/16	1/2	10202-44-08	6.06

* 12" diameter wheel only has two wheels for 3" wide design.
All dimensions are in inches. All weights are in pounds.

CONTINUED

WHEELS TWERGO®

PRECISION BALL BEARING (3 WHEEL DESIGN - 3" WIDTH)

Diameter	Width	Material	Capacity	Hub Length	Bore	Part Number	Weight
4	3.00	T/R Polyurethane	1,020	3 1/2	3/4	04302-93-12	2.54
4	3.00	T/R-95 Polyurethane	1,575	3 1/2	3/4	04302-94-12	2.54
4	3.00	ErgoTread	970	3 1/2	3/4	04302-44-12	2.54
5	3.00	T/R Polyurethane	1,225	3 1/2	3/4	05302-93-12	3.97
5	3.00	T/R-95 Polyurethane	1,755	3 1/2	3/4	05302-94-12	3.97
5	3.00	ErgoTread	1,160	3 1/2	3/4	05302-44-12	3.97
6	3.00	T/R Polyurethane	1,640	3 1/2	3/4	06302-93-12	4.56
6	3.00	T/R-95 Polyurethane	2,070	3 1/2	3/4	06302-94-12	4.56
6	3.00	ErgoTread	1,560	3 1/2	3/4	06302-44-12	4.56
8	3.00	T/R Polyurethane	2,000	3 1/2	3/4	08302-93-12	6.86
8	3.00	T/R-95 Polyurethane	2,800	3 1/2	3/4	08302-94-12	6.86
8	3.00	ErgoTread	1,900	3 1/2	3/4	08302-44-12	6.86
10	3.00	T/R Polyurethane	2,400	3 1/2	3/4	10302-93-12	8.97
10	3.00	T/R-95 Polyurethane	3,100	3 1/2	3/4	10302-94-12	8.97
10	3.00	ErgoTread	2,280	3 1/2	3/4	10302-44-12	8.97
12	3.00	T/R Polyurethane	2,800	3 1/2	3/4	12302-93-12*	11.60
12	3.00	T/R-95 Polyurethane	3,400	3 1/2	3/4	12302-94-12*	11.60
12	3.00	ErgoTread	2,660	3 1/2	3/4	12302-44-12*	11.60

* 12" diameter wheel only has two wheels for 3" wide design.
All dimensions are in inches. All weights are in pounds.



WHEELS TWERGO® LITE



MAXIMUM CAPACITY

1,800 lbs.

FEATURES

The single wheel version of our extraordinary TWERGO® wheels utilizes the same patented face design to reduce initial and continuous push force. TWERGO® Lite makes it easier to push a cart, reducing the amount of energy exerted by the operator.

TWERGO® Lite is the ultimate 2" wide wheel. It is designed to replace standard caster wheels by adding significant ergonomic benefits, without significantly increasing the price. TWERGO® Lite has a cast iron core, making it durable and strong enough to handle challenging environments. A tapered tread design helps to resist debris and push it away.

Wheels: 5" to 8" diameter wheels.

APPLICATIONS

TWERGO® Lite is a great replacement to the conventional cast iron wheel, it offers the same cast iron core, while adding ergonomic benefits, making it a great choice for indoor applications like carts, racks, AGV's, and tug trains.

BENEFITS

The benefits of TWERGO® Lite include:

- Ergonomic, reduce force exerted to start and continue rolling
- Durable and Strong with a Cast Iron Core
- Maintenance-free bearings never need greasing

For optimal ergonomic benefit, we recommend using TWERGO® Lite wheels on our ErgoXcel™ line of kingpinless, maintenance-free ergonomic rigs, including the 37, 55, 57 and 87 Series.

WHEELS TWERGO® LITE

PRECISION BALL BEARING

Diameter	Width	Material	Capacity	Hub Length	Bore	Part Number	Weight
5	2.00	T/R Polyurethane	840	2 7/16	1/2	05202-46-08	3.00
5	2.00	T/R-95 Polyurethane	1,170	2 7/16	1/2	05202-47-08	3.00
5	2.00	ErgoTread	800	2 7/16	1/2	05202-42-08	3.00
6	2.00	T/R Polyurethane	960	2 7/16	1/2	06202-46-08	4.50
6	2.00	T/R-95 Polyurethane	1,400	2 7/16	1/2	06202-47-08	4.50
6	2.00	ErgoTread	900	2 7/16	1/2	06202-42-08	4.50
8	2.00	T/R Polyurethane	1,240	2 7/16	1/2	08202-46-08	8.00
8	2.00	T/R-95 Polyurethane	1,800	2 7/16	1/2	08202-47-08	8.00
8	2.00	ErgoTread	1,100	2 7/16	1/2	08202-42-08	8.00
10	2.00	T/R Polyurethane	1,600	2 7/16	1/2	10202-46-08	8.00
10	2.00	T/R-95 Polyurethane	2,050	2 7/16	1/2	10202-47-08	8.00
10	2.00	ErgoTread	1,440	2 7/16	1/2	10202-42-08	8.00

All dimensions are in inches. All weights are in pounds.

WHEELS POLYURETHANE



MAXIMUM CAPACITY

11,250 lbs.

FEATURES

Bearings: Precision ball, straight roller, precision tapered, delrin, oilite, bearingless.

TESTING

In-house test dynamometers, with sophisticated metering equipment, allow Caster Concepts to develop test parameters for product duty – life cycle profile testing and performance evaluations prior to delivery to the field.

BENEFITS

Caster Concepts processes polyurethane tread material in house, allowing us to create custom formulations to conquer specific challenges. We offer tread materials to help with ergonomics, high speed powered applications, harsh environments, chemicals, moisture and many more challenges.

METRIC WHEELS

The capability to control the production of wheels through design, production, product testing and final shipment, has driven Caster Concepts to design and develop a full line of metric wheels for replacement on equipment produced in Europe and Asia.

Metric Wheel Diameters		
50mm	180mm	230mm
80mm	200mm	250mm
125mm	220mm	300mm

WHEELS POLYURETHANE

STRAIGHT ROLLER BEARING (Soft Poly - T/R-85A)

Diameter	Width	Capacity	Hub Length	Bore	Part Number	Weight
4	2.00	600	2 3/16	3/4	04201-61-12	3.00
4	3.25	1,020	3 1/4	1	04321-61-16	5.00
4	3.25	1,020	3 1/4	1 1/4	04321-61-20	5.00
4	4.00	1,280	4 1/4	1 1/4	04401-61-20	10.00
4	4.00	1,280	4 1/4	1 1/2	04401-61-24	10.00
5	2.00	840	2 3/16	3/4	05201-61-12	3.00
5	2.50	1,060	3 1/4	1	05251-61-16	7.00
5	2.50	1,060	3 1/4	1 1/4	05251-61-20	7.00
5	3.00	1,225	3 1/4	1	05301-61-16	9.00
5	3.00	1,225	3 1/4	1 1/4	05301-61-20	9.00
6	2.00	960	2 3/16	3/4	06201-61-12	4.50
6	2.50	1,300	3 1/4	1	06251-61-16	6.50
6	2.50	1,300	3 1/4	1 1/4	06251-61-20	6.50
6	3.00	1,640	3 1/4	1	06301-61-16	9.50
6	3.00	1,640	3 1/4	1 1/4	06301-61-20	9.50
8	2.00	1,240	2 3/16	3/4	08201-61-12	8.00
8	2.50	1,640	3 1/4	1	08251-61-16	9.50
8	2.50	1,640	3 1/4	1 1/4	08251-61-20	9.50
8	3.00	2,000	3 1/4	1	08301-61-16	12.50
8	3.00	2,000	3 1/4	1 1/4	08301-61-20	12.50
8	4.00	3,040	4 1/4	1 1/4	08401-61-20	20.00
8	4.00	3,040	4 1/4	1 1/2	08401-61-24	20.00
10	3.00	2,400	3 1/4	1	10301-61-16	16.00
10	3.00	2,400	3 1/4	1 1/4	10301-61-20	16.00
10	4.00	3,360	4 1/4	1 1/4	10401-61-20	23.00
10	4.00	3,360	4 1/4	1 1/2	10401-61-24	23.00
12	3.00	2,800	3 1/4	1	12301-61-16	21.00
12	3.00	2,800	3 1/4	1 1/4	12301-61-20	21.00

CONTINUED

All dimensions are in inches. All weights are in pounds.

WHEELS POLYURETHANE

STRAIGHT ROLLER BEARING (Soft Poly - T/R-85A - 1" Thick Tread)

Diameter	Width	Capacity	Hub Length	Bore	Part Number	Weight
6	3.00	2,050	3 1/4	1	06301-66-16	9.50
6	3.00	2,050	3 1/4	1 1/4	06301-66-20	9.50
6	4.00	2,400	4 1/4	1 1/4	06401-66-20	17.00
6	4.00	2,400	4 1/4	1 1/2	06401-66-24	17.00
6	5.00	2,960	5 1/4	1 1/4	06501-66-20	20.00
6	5.00	2,960	5 1/4	1 1/2	06501-66-24	20.00
8	3.00	2,480	3 1/4	1	08301-66-16	17.00
8	3.00	2,480	3 1/4	1 1/4	08301-66-20	17.00
10	3.00	2,960	3 1/4	1	10301-66-16	24.00
10	3.00	2,960	3 1/4	1 1/4	10301-66-20	24.00
10	3.00	2,960	3 1/4	1 1/2	10301-69-24	24.00
10	4.00	4,000	4 1/4	1 1/4	10401-66-20	33.00
10	4.00	4,000	4 1/4	1 1/2	10401-66-24	33.00
10	5.00	4,800	5 1/4	1 1/4	10501-66-20	45.00
12	3.00	3,080	3 1/4	1 1/4	12301-66-20	24.00
12	3.00	3,080	3 1/4	1 1/2	12301-66-24	24.00
12	4.00	4,400	4 1/4	1 1/4	12401-66-20	30.00
12	4.00	4,400	4 1/4	1 1/2	12401-66-24	30.00
12	5.00	5,200	5 1/4	1 1/4	12501-66-20	45.00
12	5.00	5,200	5 1/4	1 1/2	12501-66-24	45.00
16	4.00	4,825	4 1/4	1 1/4	16401-66-20	40.00
16	4.00	4,825	4 1/4	1 1/2	16401-66-24	40.00
16	5.00	6,000	5 1/4	1 1/4	16501-66-20	72.00
16	5.00	6,000	5 1/4	1 1/2	16501-66-24	72.00
18	5.00	6,400	5 1/4	1 1/4	18501-66-20	90.00
18	5.00	6,400	5 1/4	1 1/2	18501-66-24	90.00
20	5.00	6,750	5 1/4	1 1/4	20501-66-20	110.00
20	5.00	6,750	5 1/4	1 1/2	20501-66-24	110.00
20	5.00	6,750	5 1/4	2	20501-66-32	110.00

CONTINUED

WHEELS POLYURETHANE

PRECISION TAPERED BEARING (Soft Poly - T/R-85A)

Diameter	Width	Capacity	Hub Length	Bore	Part Number	Weight
4	2.00	600	2 7/16	1/2	04209-61-08	3.00
4	3.25	1,020	3 1/2	3/4	04329-61-12	5.00
4	3.25	1,020	3 1/2	1	04329-61-16	5.00
4	4.00	1,280	4 1/2	1	04409-61-16	10.00
4	4.00	1,280	4 1/2	1 1/4	04409-61-20	10.00
5	2.00	840	2 7/16	1/2	05209-61-08	3.00
5	2.50	1,060	3 1/2	3/4	05259-61-12	7.00
5	2.50	1,060	3 1/2	1	05259-61-16	7.00
5	3.00	1,225	3 1/4	3/4	05309-61-12	9.00
5	3.00	1,225	3 1/4	1	05309-61-16	9.00
6	2.00	960	2 7/16	1/2	06209-61-08	4.50
6	2.00	960	2 7/16	3/4	06209-61-12	4.50
6	2.50	1,300	3 1/2	3/4	06259-61-12	6.50
6	2.50	1,300	3 1/2	1	06259-61-16	6.50
6	3.00	1,640	3 1/2	3/4	06309-61-12	9.50
6	3.00	1,640	3 1/2	1	06309-61-16	9.50
6	3.00	1,640	3 1/2	1 1/4	06309-61-20	9.50
8	2.00	1,240	2 7/16	3/4	08209-61-12	8.00
8	2.50	1,640	3 1/2	3/4	08259-61-12	9.50
8	2.50	1,640	3 1/2	1	08259-61-16	9.50
8	3.00	2,000	3 1/2	3/4	08309-61-12	12.50
8	3.00	2,000	3 1/2	1	08309-61-16	12.50
8	3.00	2,000	3 1/2	1 1/4	08309-61-20	12.50
8	4.00	3,040	4 1/2	1	08409-61-16	20.00
8	4.00	3,040	4 1/2	1 1/4	08409-61-20	20.00
10	3.00	2,400	3 1/2	3/4	10309-61-12	16.00
10	3.00	2,400	3 1/2	1	10309-61-16	16.00
10	3.00	2,400	3 1/2	1 1/4	10309-61-20	16.00
10	4.00	3,360	4 1/2	1	10409-61-16	23.00
10	4.00	3,360	4 1/2	1 1/4	10409-61-20	23.00
12	3.00	2,800	3 1/2	3/4	12309-61-12	21.00
12	3.00	2,800	3 1/2	1	12309-61-16	21.00
12	3.00	2,800	3 1/2	1 1/4	12309-61-20	21.00

CONTINUED

All dimensions are in inches. All weights are in pounds.

WHEELS POLYURETHANE

PRECISION TAPERED BEARING (Soft Poly - T/R-85A - 1" Thick Tread)

Diameter	Width	Capacity	Hub Length	Bore	Part Number	Weight
6	3.00	2,050	3 1/2	3/4	06309-66-12	9.50
6	4.00	2,050	3 1/2	1	06309-66-16	9.50
6	4.00	2,400	4 1/2	1	06409-66-16	17.00
6	4.00	2,400	4 1/2	1 1/4	06409-66-20	17.00
6	5.00	2,960	5 1/2	1	06509-66-16	20.00
6	5.00	2,960	5 1/2	1 1/4	06509-66-20	20.00
8	3.00	2,480	3 1/2	3/4	08309-66-12	17.00
8	3.00	2,480	3 1/2	1	08309-66-16	17.00
10	3.00	2,960	3 1/2	3/4	10309-66-12	24.00
10	3.00	2,960	3 1/2	1	10309-66-16	24.00
10	3.00	2,960	3 1/2	1 1/4	10309-69-20	24.00
10	4.00	4,000	4 1/2	1	10409-66-16	33.00
10	4.00	4,000	4 1/2	1 1/4	10409-66-20	33.00
12	3.00	3,080	3 1/2	1	12309-66-16	24.00
12	3.00	3,080	3 1/2	1 1/4	12309-66-20	24.00
12	4.00	4,400	4 1/2	1	12409-66-16	30.00
12	4.00	4,400	4 1/2	1 1/4	12409-66-20	30.00
12	5.00	5,200	5 1/2	1	12509-66-16	45.00
12	5.00	5,200	5 1/2	1 1/4	12509-66-20	45.00
16	4.00	4,825	4 1/2	1	16409-66-16	40.00
16	4.00	4,825	4 1/2	1 1/4	16409-66-20	40.00
16	5.00	6,000	5 1/2	1	16509-66-16	72.00
16	5.00	6,000	5 1/2	1 1/4	16509-66-20	72.00
18	5.00	6,400	5 1/2	1	18509-66-16	90.00
18	5.00	6,400	5 1/2	1 1/4	18509-66-20	90.00
20	5.00	6,750	5 1/2	1	20509-66-16	110.00
20	5.00	6,750	5 1/2	1 1/4	20509-66-20	110.00
20	5.00	6,750	5 1/2	1 1/2	20509-66-24	110.00
20	5.00	6,750	5 1/2	2	20509-66-32	110.00

CONTINUED

WHEELS POLYURETHANE

BEARINGLESS (Soft Poly - T/R-85A)

Diameter	Width	Capacity	Hub Length	Bore	Part Number	Weight
4	2.00	600	2 3/16	1 3/16	04200-61-19	3.00
4	3.25	1,020	3 1/4	1 15/16	04320-61-31	5.00
4	4.00	1,280	4 1/4	2 7/16	04400-61-39	10.00
5	2.00	840	2 3/16	1 3/16	05200-61-19	3.00
5	2.50	1,060	3 1/4	1 15/16	05250-61-31	7.00
5	3.00	1,225	3 1/4	1 15/16	05300-61-31	9.00
6	2.00	960	2 3/16	1 1/5	06200-61-19	4.50
6	2.50	1,300	3 1/4	1 15/16	06250-61-31	6.50
6	3.00	1,640	3 1/4	1 15/16	06300-61-31	9.50
8	2.00	1,240	2 3/16	1 3/16	08200-61-19	8.00
8	2.50	1,640	3 1/4	1 15/16	08250-61-31	9.50
8	3.00	2,000	3 1/4	1 15/16	08300-61-31	12.50
8	4.00	3,040	4 1/4	2 7/16	08400-61-39	20.00
10	3.00	2,400	3 1/4	1 8/9	10300-61-31	16.00
10	4.00	3,360	4 1/4	2 7/16	10400-61-39	23.00
12	3.00	2,800	3 1/4	1 15/16	12300-61-31	21.00

BEARINGLESS (Soft Poly - T/R-85A - 1" Thick Tread)

Diameter	Width	Capacity	Hub Length	Bore	Part Number	Weight
6	3.00	2,050	3 1/4	1 15/16	06300-66-31	9.50
6	4.00	2,400	4 1/4	2 7/16	06400-66-39	17.00
6	5.00	2,960	5 1/4	2 7/16	06500-66-39	20.00
8	3.00	2,480	3 1/4	1 15/16	08300-66-31	17.00
10	3.00	2,960	3 1/4	2 7/16	10300-69-39	24.00
10	3.00	2,960	3 1/4	1 15/16	10300-66-31	24.00
10	4.00	4,000	4 1/4	2 7/16	10400-66-39	33.00
10	5.00	4,800	5 1/4	2 7/16	10500-66-39	45.00
12	3.00	3,080	3 1/4	2 7/16	12300-66-39	24.00
12	4.00	4,400	4 1/4	2 7/16	12400-66-39	30.00
12	5.00	5,200	5 1/4	2 7/16	12500-66-39	45.00
16	4.00	4,825	4 1/4	2 7/16	16400-66-39	40.00
16	5.00	6,000	5 1/4	2 7/16	16500-66-39	72.00
18	5.00	6,400	5 1/4	2 7/16	18500-66-39	90.00
20	5.00	6,750	5 1/4	2 7/16	20500-66-39	110.00

CONTINUED

All dimensions are in inches. All weights are in pounds.

WHEELS POLYURETHANE

PRECISION BALL BEARING (Soft Poly - T/R-85A)

Diameter	Width	Capacity	Hub Length	Bore	Part Number	Weight
5	2.00	840	2 7/16	1/2	05202-61-08	3.00
6	2.00	960	2 7/16	1/2	06202-61-08	4.50
6	3.00	1,640	3 1/2	3/4	06302-61-12	9.50
8	2.00	1,240	2 7/16	1/2	08202-61-08	8.00
8	2.50	1,640	3 1/2	3/4	08252-61-12	9.50
8	3.00	2,000	3 1/2	3/4	08302-61-12	12.50
8	3.00	2,000	3 1/2	1	08302-61-16	12.50
10	3.00	2,400	3 1/2	3/4	10302-61-12	16.00
10	3.00	2,400	3 1/2	1	10302-61-16	16.00
12	3.00	2,800	3 1/2	3/4	12302-61-12	21.00
12	3.00	2,800	3 1/2	1	12302-61-16	21.00
12	3.00	2,800	3 1/2	1 1/4	12302-61-20	21.00

PRECISION BALL BEARING (Soft Poly - T/R-85A - 1" Thick Tread)

Diameter	Width	Capacity	Hub Length	Bore	Part Number	Weight
4	2.00	600	2 7/16	1/2	04202-66-08	3.00

PRECISION BALL BEARING (Soft Poly - Round Tread - T/R-85A)

Diameter	Width	Capacity	Hub Length	Bore	Part Number	Weight
4	2.00	500	2 7/16	1/2	04202-51-08	3.00
6	2.00	800	2 7/16	1/2	06202-51-08	4.00
8	2.00	1,000	2 7/16	1/2	08202-51-08	5.50
12	1.75	1,500	3 1/2	3/4	12172-61-12	18.00



BALLOON
ROUND TREAD

CONTINUED

WHEELS POLYURETHANE

STRAIGHT ROLLER BEARING (Standard Poly - 95A)

Diameter	Width	Capacity	Hub Length	Bore	Part Number	Weight
4	2.00	750	2 3/16	3/4	04201-60-12	3.00
4	3.25	1,275	3 1/4	1	04321-60-16	5.00
4	3.25	1,275	3 1/4	1 1/4	04321-60-20	5.00
4	4.00	1,600	4 1/4	1 1/4	04401-60-20	10.00
4	4.00	1,600	4 1/4	1 1/2	04401-60-24	10.00
5	2.00	1,050	2 3/16	3/4	05201-60-12	3.00
5	2.50	1,325	3 1/4	1	05251-60-16	7.00
5	2.50	1,325	3 1/4	1 1/4	05251-60-20	7.00
5	3.00	1,335	3 1/4	1	05301-60-16	9.00
5	3.00	1,530	3 1/4	1 1/4	05301-60-20	9.00
6	2.00	1,200	2 3/16	3/4	06201-60-12	4.50
6	2.50	1,625	3 1/4	1	06251-60-16	6.50
6	2.50	1,625	3 1/4	1 1/4	06251-60-20	6.50
6	3.00	2,050	3 1/4	1	06301-60-16	9.50
6	3.00	2,050	3 1/4	1 1/4	06301-60-20	9.50
8	2.00	1,550	2 3/16	3/4	08201-60-12	8.00
8	2.50	2,050	3 1/4	1	08251-60-16	9.50
8	2.50	2,050	3 1/4	1 1/4	08251-60-20	9.50
8	3.00	2,500	3 1/4	1	08301-60-16	12.50
8	3.00	2,500	3 1/4	1 1/4	08301-60-20	12.50
8	4.00	3,800	4 1/4	1 1/4	08401-60-20	20.00
8	4.00	3,800	4 1/4	1 1/2	08401-60-24	20.00
10	3.00	3,000	3 1/4	1	10301-60-16	16.00
10	3.00	3,000	3 1/4	1 1/4	10301-60-20	16.00
10	4.00	4,200	4 1/4	1 1/4	10401-60-20	23.00
10	4.00	4,200	4 1/4	1 1/2	10401-60-24	23.00
12	3.00	3,500	3 1/4	1	12301-60-16	21.00
12	3.00	3,500	3 1/4	1 1/4	12301-60-20	21.00

CONTINUED

WHEELS POLYURETHANE

STRAIGHT ROLLER BEARING (Standard Poly - 95A - 1" Thick Tread)

Diameter	Width	Capacity	Hub Length	Bore	Part Number	Weight
6	3.00	2,450	3 1/4	1	06301-65-16	9.50
6	3.00	2,450	3 1/4	1 1/4	06301-65-20	9.50
6	4.00	3,000	4 1/4	1 1/4	06401-65-20	17.00
6	4.00	3,000	4 1/4	1 1/2	06401-65-24	17.00
6	5.00	3,700	5 1/4	1 1/4	06501-65-20	20.00
6	5.00	3,700	5 1/4	1 1/2	06501-65-24	20.00
8	3.00	3,100	3 1/4	1	08301-65-16	17.00
8	3.00	3,100	3 1/4	1 1/4	08301-65-20	17.00
10	3.00	3,700	3 1/4	1	10301-65-16	24.00
10	3.00	3,700	3 1/4	1 1/4	10301-65-20	24.00
10	3.00	3,700	3 1/4	1 1/2	10301-68-24	24.00
10	4.00	5,000	4 1/4	1 1/4	10401-65-20	33.00
10	4.00	5,000	4 1/4	1 1/2	10401-65-24	33.00
10	5.00	6,000	5 1/4	1 1/4	10501-65-20	45.00
12	3.00	3,850	3 1/4	1 1/4	12301-65-20	24.00
12	3.00	3,850	3 1/4	1 1/2	12301-65-24	24.00
12	4.00	5,500	4 1/4	1 1/4	12401-65-20	30.00
12	4.00	5,500	4 1/4	1 1/2	12401-65-24	30.00
12	5.00	6,500	5 1/4	1 1/4	12501-65-20	45.00
12	5.00	6,500	5 1/4	1 1/2	12501-65-24	45.00
16	4.00	6,000	4 1/4	1 1/4	16401-65-20	40.00
16	4.00	6,000	4 1/4	1 1/2	16401-65-24	40.00
16	5.00	8,000	5 1/4	1 1/4	16501-65-20	72.00
16	5.00	8,000	5 1/4	1 1/2	16501-65-24	72.00
18	5.00	8,500	5 1/4	1 1/4	18501-65-20	90.00
18	5.00	8,500	5 1/4	1 1/2	18501-65-24	90.00
20	5.00	9,000	5 1/4	1 1/4	20501-65-20	110.00
20	5.00	9,000	5 1/4	1 1/2	20501-65-24	110.00
20	5.00	9,000	5 1/4	2	20501-65-32	110.00

CONTINUED

WHEELS POLYURETHANE

PRECISION TAPERED BEARING (Standard Poly - 95A)

Diameter	Width	Capacity	Hub Length	Bore	Part Number	Weight
4	2.00	750	2 7/16	1/2	04209-60-08	3.00
4	3.25	1,275	3 1/2	3/4	04329-60-12	5.00
4	3.25	1,275	3 1/2	1	04329-60-16	5.00
4	4.00	1,600	4 1/2	1	04409-60-16	10.00
4	4.00	1,600	4 1/2	1 1/4	04409-60-20	10.00
5	2.00	1,050	2 7/16	1/2	05209-60-08	3.00
5	2.50	1,325	3 1/2	3/4	05259-60-12	7.00
5	2.50	1,325	3 1/2	1	05259-60-16	7.00
5	3.00	1,530	3 1/4	3/4	05309-60-12	9.00
5	3.00	1,530	3 1/4	1	05309-60-16	9.00
6	2.00	1,200	2 7/16	1/2	06209-60-08	4.50
6	2.00	1,200	2 7/16	3/4	06209-60-12	4.50
6	2.50	1,625	3 1/2	3/4	06259-60-12	6.50
6	2.50	1,625	3 1/2	1	06259-60-16	6.50
6	3.00	2,050	3 1/2	3/4	06309-60-12	9.50
6	3.00	2,050	3 1/2	1	06309-60-16	9.50
6	3.00	2,050	3 1/2	1 1/4	06309-60-20	9.50
8	2.00	1,550	2 7/16	3/4	08209-60-12	8.00
8	2.50	2,050	3 1/2	3/4	08259-60-12	9.50
8	2.50	2,050	3 1/2	1	08259-60-16	9.50
8	3.00	2,500	3 1/2	3/4	08309-60-12	12.50
8	3.00	2,500	3 1/2	1	08309-60-16	12.50
8	3.00	2,500	3 1/2	1 1/4	08309-60-20	12.50
8	4.00	3,800	4 1/2	1	08409-60-16	20.00
8	4.00	3,800	4 1/2	1 1/4	08409-60-20	20.00
10	3.00	3,000	3 1/2	3/4	10309-60-12	16.00
10	3.00	3,000	3 1/2	1	10309-60-16	16.00
10	3.00	3,000	3 1/2	1 1/4	10309-60-20	16.00
10	4.00	4,200	4 1/2	1	10409-60-16	23.00
10	4.00	4,200	4 1/2	1 1/4	10409-60-20	23.00
12	3.00	3,500	3 1/2	3/4	12309-60-12	21.00
12	3.00	3,500	3 1/2	1	12309-60-16	21.00
12	3.00	3,500	3 1/2	1 1/4	12309-60-20	21.00

CONTINUED

All dimensions are in inches. All weights are in pounds.

WHEELS POLYURETHANE

PRECISION TAPERED BEARING (Standard Poly - 95A - 1" Thick Tread)

Diameter	Width	Capacity	Hub Length	Bore	Part Number	Weight
6	3.00	2,450	3 1/2	3/4	06309-65-12	9.50
6	4.00	2,450	3 1/2	1	06309-65-16	9.50
6	4.00	3,000	4 1/2	1	06409-65-16	17.00
6	4.00	3,000	4 1/2	1 1/4	06409-65-20	17.00
6	5.00	3,700	5 1/2	1	06509-65-16	20.00
6	5.00	3,700	5 1/2	1 1/4	06509-65-20	20.00
8	3.00	3,100	3 1/2	3/4	08309-65-12	17.00
8	3.00	3,100	3 1/2	1	08309-65-16	17.00
10	3.00	3,700	3 1/2	3/4	10309-65-12	24.00
10	3.00	3,700	3 1/2	1	10309-65-16	24.00
10	3.00	3,700	3 1/2	1 1/4	10309-68-20	24.00
10	4.00	5,000	4 1/2	1	10409-65-16	33.00
10	4.00	5,000	4 1/2	1 1/4	10409-65-20	33.00
12	3.00	3,850	3 1/2	1	12309-65-16	24.00
12	3.00	3,850	3 1/2	1 1/4	12309-65-20	24.00
12	4.00	5,500	4 1/2	1	12409-65-16	30.00
12	4.00	5,500	4 1/2	1 1/4	12409-65-20	30.00
12	5.00	6,500	5 1/2	1	12509-65-16	45.00
12	5.00	6,500	5 1/2	1 1/4	12509-65-20	45.00
16	4.00	6,000	4 1/2	1	16409-65-16	40.00
16	4.00	6,000	4 1/2	1 1/4	16409-65-20	40.00
16	5.00	8,000	5 1/2	1	16509-65-16	72.00
16	5.00	8,000	5 1/2	1 1/4	16509-65-20	72.00
18	5.00	8,500	5 1/2	1	18509-65-16	90.00
18	5.00	8,500	5 1/2	1 1/4	18509-65-20	90.00
20	5.00	9,000	5 1/2	1	20509-65-16	110.00
20	5.00	9,000	5 1/2	1 1/4	20509-65-20	110.00
20	5.00	9,000	5 1/2	1 1/2	20509-65-24	110.00
20	5.00	9,000	5 1/2	2	20509-65-32	110.00

CONTINUED

WHEELS POLYURETHANE

BEARINGLESS (Standard Poly - 95A)

Diameter	Width	Capacity	Hub Length	Bore	Part Number	Weight
4	2.00	750	2 3/16	1 3/16	04200-60-19	3.00
4	3.25	1,275	3 1/4	1 15/16	04320-60-31	5.00
4	4.00	1,600	4 1/4	2 7/16	04400-60-39	10.00
5	2.00	1,050	2 3/16	1 3/16	05200-60-19	3.00
5	2.50	1,325	3 1/4	1 15/16	05250-60-31	7.00
5	3.00	1,530	3 1/4	1 15/16	05300-60-31	9.00
6	2.00	1,200	2 3/16	1 1/5	06200-60-19	4.50
6	2.50	1,625	3 1/4	1 15/16	06250-60-31	6.50
6	3.00	2,050	3 1/4	1 15/16	06300-60-31	9.50
8	2.00	1,550	2 3/16	1 3/16	08200-60-19	8.00
8	2.50	2,050	3 1/4	1 15/16	08250-60-31	9.50
8	3.00	2,500	3 1/4	1 15/16	08300-60-31	12.50
8	4.00	3,800	4 1/4	2 7/16	08400-60-39	20.00
10	3.00	3,000	3 1/4	1 8/9	10300-60-31	16.00
10	4.00	4,200	4 1/4	2 7/16	10400-60-39	23.00
12	3.00	3,500	3 1/4	1 15/16	12300-60-31	21.00

BEARINGLESS (Standard Poly - 95A - 1" Thick Tread)

Diameter	Width	Capacity	Hub Length	Bore	Part Number	Weight
6	3.00	2,450	3 1/4	1 15/16	06300-65-31	9.50
6	4.00	3,000	4 1/4	2 7/16	06400-65-39	17.00
6	5.00	3,700	5 1/4	2 7/16	06500-65-39	20.00
8	3.00	3,100	3 1/4	1 15/16	08300-65-31	17.00
10	3.00	3,700	3 1/4	2 7/16	10300-68-39	24.00
10	3.00	3,700	3 1/4	1 15/16	10300-65-31	24.00
10	4.00	5,000	4 1/4	2 7/16	10400-65-39	33.00
10	5.00	6,000	5 1/4	2 7/16	10500-65-39	45.00
12	3.00	3,850	3 1/4	2 7/16	12300-65-39	24.00
12	4.00	5,500	4 1/4	2 7/16	12400-65-39	30.00
12	5.00	6,500	5 1/4	2 7/16	12500-65-39	45.00
16	4.00	6,000	4 1/4	2 7/16	16400-65-39	40.00
16	5.00	8,000	5 1/4	2 7/16	16500-65-39	72.00
18	5.00	8,500	5 1/4	2 7/16	18500-65-39	90.00
20	5.00	9,000	5 1/4	2 7/16	20500-65-39	110.00

CONTINUED

All dimensions are in inches. All weights are in pounds.

WHEELS POLYURETHANE

PRECISION BALL BEARING (Standard Poly - 95A)

Diameter	Width	Capacity	Hub Length	Bore	Part Number	Weight
5	2.00	1,050	2 7/16	1/2	05202-60-08	3.00
6	2.00	1,200	2 7/16	1/2	06202-60-08	4.50
6	3.00	2,050	3 1/2	3/4	06302-60-12	9.50
8	2.00	1,550	2 7/16	1/2	08202-60-08	8.00
8	2.50	2,050	3 1/2	3/4	08252-60-12	9.50
8	3.00	2,500	3 1/2	3/4	08302-60-12	12.50
8	3.00	2,500	3 1/2	1	08302-60-16	12.50
10	3.00	3,000	3 1/2	3/4	10302-60-12	16.00
10	3.00	3,000	3 1/2	1	10302-60-16	16.00
12	3.00	3,500	3 1/2	3/4	12302-60-12	21.00
12	3.00	3,500	3 1/2	1	12302-60-16	21.00
12	3.00	3,500	3 1/2	1 1/4	12302-60-20	21.00

PRECISION BALL BEARING (Standard Poly - 95A - 1" Thick Tread)

Diameter	Width	Capacity	Hub Length	Bore	Part Number	Weight
4	2.00	750	2 7/16	1/2	04202-65-08	3.00

PRECISION BALL BEARING (Standard Poly - Round Tread - 95A)

Diameter	Width	Capacity	Hub Length	Bore	Part Number	Weight
4	2.00	600	2 7/16	1/2	04202-50-08	3.00
6	2.00	1,000	2 7/16	1/2	06202-50-08	4.00
8	2.00	1,240	2 7/16	1/2	08202-50-08	5.50
12	1.75	1,700	3 1/2	3/4	12172-60-12	18.00



BALLOON
ROUND TREAD

CONTINUED

WHEELS POLYURETHANE

STRAIGHT ROLLER BEARING (Hard Poly - 70D)

Diameter	Width	Capacity	Hub Length	Bore	Part Number	Weight
4	2.00	900	2 3/16	3/4	04201-63-12	3.00
4	3.25	1,530	3 1/4	1	04321-63-16	5.00
4	3.25	1,530	3 1/4	1 1/4	04321-63-20	5.00
4	4.00	1,920	4 1/4	1 1/4	04401-63-20	10.00
4	4.00	1,920	4 1/4	1 1/2	04401-63-24	10.00
5	2.00	1,260	2 3/16	3/4	05201-63-12	3.00
5	2.50	1,590	3 1/4	1	05251-63-16	7.00
5	2.50	1,590	3 1/4	1 1/4	05251-63-20	7.00
5	3.00	1,335	3 1/4	1	05301-63-16	9.00
5	3.00	1,836	3 1/4	1 1/4	05301-63-20	9.00
6	2.00	1,440	2 3/16	3/4	06201-63-12	4.50
6	2.50	1,950	3 1/4	1	06251-63-16	6.50
6	2.50	1,950	3 1/4	1 1/4	06251-63-20	6.50
6	3.00	2,460	3 1/4	1	06301-63-16	9.50
6	3.00	2,460	3 1/4	1 1/4	06301-63-20	9.50
8	2.00	1,860	2 3/16	3/4	08201-63-12	8.00
8	2.50	2,460	3 1/4	1	08251-63-16	9.50
8	2.50	2,460	3 1/4	1 1/4	08251-63-20	9.50
8	3.00	3,000	3 1/4	1	08301-63-16	12.50
8	3.00	3,000	3 1/4	1 1/4	08301-63-20	12.50
8	4.00	4,560	4 1/4	1 1/4	08401-63-20	20.00
8	4.00	4,560	4 1/4	1 1/2	08401-63-24	20.00
10	3.00	3,600	3 1/4	1	10301-63-16	16.00
10	3.00	3,600	3 1/4	1 1/4	10301-63-20	16.00
10	4.00	5,040	4 1/4	1 1/4	10401-63-20	23.00
10	4.00	5,040	4 1/4	1 1/2	10401-63-24	23.00
12	3.00	4,200	3 1/4	1	12301-63-16	21.00
12	3.00	4,200	3 1/4	1 1/4	12301-63-20	21.00

CONTINUED

All dimensions are in inches. All weights are in pounds.

WHEELS POLYURETHANE

STRAIGHT ROLLER BEARING (Hard Poly - 70D - 1" Thick Tread)

Diameter	Width	Capacity	Hub Length	Bore	Part Number	Weight
6	3.00	2,950	3 1/4	1	06301-67-16	9.50
6	3.00	2,950	3 1/4	1 1/4	06301-67-20	9.50
6	4.00	3,600	4 1/4	1 1/4	06401-67-20	17.00
6	4.00	3,600	4 1/4	1 1/2	06401-67-24	17.00
6	5.00	4,400	5 1/4	1 1/4	06501-67-20	20.00
6	5.00	4,400	5 1/4	1 1/2	06501-67-24	20.00
8	3.00	3,500	3 1/4	1	08301-67-16	17.00
8	3.00	3,500	3 1/4	1 1/4	08301-67-20	17.00
10	3.00	4,400	3 1/4	1	10301-67-16	24.00
10	3.00	4,400	3 1/4	1 1/4	10301-67-20	24.00
10	3.00	4,400	3 1/4	1 1/2	10301-67-24	24.00
10	4.00	6,000	4 1/4	1 1/4	10401-67-20	33.00
10	4.00	6,000	4 1/4	1 1/2	10401-67-24	33.00
10	5.00	7,200	5 1/4	1 1/4	10501-67-20	45.00
12	3.00	4,620	3 1/4	1 1/4	12301-67-20	24.00
12	3.00	4,620	3 1/4	1 1/2	12301-67-24	24.00
12	4.00	6,600	4 1/4	1 1/4	12401-67-20	30.00
12	4.00	6,600	4 1/4	1 1/2	12401-67-24	30.00
12	5.00	7,800	5 1/4	1 1/4	12501-67-20	45.00
12	5.00	7,800	5 1/4	1 1/2	12501-67-24	45.00
16	4.00	8,000	4 1/4	1 1/4	16401-67-20	40.00
16	4.00	8,000	4 1/4	1 1/2	16401-67-24	40.00
16	5.00	9,000	5 1/4	1 1/4	16501-67-20	72.00
16	5.00	9,000	5 1/4	1 1/2	16501-67-24	72.00
18	5.00	9,000	5 1/4	1 1/4	18501-67-20	90.00
18	5.00	9,000	5 1/4	1 1/2	18501-67-24	90.00
20	5.00	10,500	5 1/4	1 1/4	20501-67-20	110.00
20	5.00	10,500	5 1/4	1 1/2	20501-67-24	110.00
20	5.00	10,500	5 1/4	2	20501-67-32	110.00

CONTINUED

WHEELS POLYURETHANE

PRECISION TAPERED BEARING (Hard Poly - 70D)

Diameter	Width	Capacity	Hub Length	Bore	Part Number	Weight
4	2.00	900	2 7/16	1/2	04209-63-08	3.00
4	3.25	1,530	3 1/2	3/4	04329-63-12	5.00
4	3.25	1,530	3 1/2	1	04329-63-16	5.00
4	4.00	1,920	4 1/2	1	04409-63-16	10.00
4	4.00	1,920	4 1/2	1 1/4	04409-63-20	10.00
5	2.00	1,260	2 7/16	1/2	05209-63-08	3.00
5	2.50	1,590	3 1/2	3/4	05259-63-12	7.00
5	2.50	1,590	3 1/2	1	05259-63-16	7.00
5	3.00	1,836	3 1/4	3/4	05309-63-12	9.00
5	3.00	1,836	3 1/4	1	05309-63-16	9.00
6	2.00	1,440	2 7/16	1/2	06209-63-08	4.50
6	2.00	1,440	2 7/16	3/4	06209-63-12	4.50
6	2.50	1,950	3 1/2	3/4	06259-63-12	6.50
6	2.50	1,950	3 1/2	1	06259-63-16	6.50
6	3.00	2,460	3 1/2	3/4	06309-63-12	9.50
6	3.00	2,460	3 1/2	1	06309-63-16	9.50
6	3.00	2,460	3 1/2	1 1/4	06309-63-20	9.50
8	2.00	1,860	2 7/16	3/4	08209-63-12	8.00
8	2.50	2,460	3 1/2	3/4	08259-63-12	9.50
8	2.50	2,460	3 1/2	1	08259-63-16	9.50
8	3.00	3,000	3 1/2	3/4	08309-63-12	12.50
8	3.00	3,000	3 1/2	1	08309-63-16	12.50
8	3.00	3,000	3 1/2	1 1/4	08309-63-20	12.50
8	4.00	4,560	4 1/2	1	08409-63-16	20.00
8	4.00	4,560	4 1/2	1 1/4	08409-63-20	20.00
10	3.00	3,600	3 1/2	3/4	10309-63-12	16.00
10	3.00	3,600	3 1/2	1	10309-63-16	16.00
10	3.00	3,600	3 1/2	1 1/4	10309-63-20	16.00
10	4.00	5,040	4 1/2	1	10409-63-16	23.00
10	4.00	5,040	4 1/2	1 1/4	10409-63-20	23.00
12	3.00	4,200	3 1/2	3/4	12309-63-12	21.00
12	3.00	4,200	3 1/2	1	12309-63-16	21.00
12	3.00	4,200	3 1/2	1 1/4	12309-63-20	21.00

CONTINUED

All dimensions are in inches. All weights are in pounds.

WHEELS POLYURETHANE

PRECISION TAPERED BEARING (Hard Poly - 70D - 1" Thick Tread)

Diameter	Width	Capacity	Hub Length	Bore	Part Number	Weight
6	3.00	2,950	3 1/2	3/4	06309-67-12	9.50
6	4.00	2,950	3 1/2	1	06309-67-16	9.50
6	4.00	3,600	4 1/2	1	06409-67-16	17.00
6	4.00	3,600	4 1/2	1 1/4	06409-67-20	17.00
6	5.00	4,400	5 1/2	1	06509-67-16	20.00
6	5.00	4,400	5 1/2	1 1/4	06509-67-20	20.00
8	3.00	3,500	3 1/2	3/4	08309-67-12	17.00
8	3.00	3,500	3 1/2	1	08309-67-16	17.00
10	3.00	4,440	3 1/2	3/4	10309-67-12	24.00
10	3.00	4,440	3 1/2	1	10309-67-16	24.00
10	3.00	4,440	3 1/2	1 1/4	10309-67-20	24.00
10	4.00	6,000	4 1/2	1	10409-67-16	33.00
10	4.00	6,000	4 1/2	1 1/4	10409-67-20	33.00
12	3.00	4,620	3 1/2	1	12309-67-16	24.00
12	3.00	4,620	3 1/2	1 1/4	12309-67-20	24.00
12	4.00	6,600	4 1/2	1	12409-67-16	30.00
12	4.00	6,600	4 1/2	1 1/4	12409-67-20	30.00
12	5.00	7,800	5 1/2	1	12509-67-16	45.00
12	5.00	7,800	5 1/2	1 1/4	12509-67-20	45.00
16	4.00	8,000	4 1/2	1	16409-67-16	40.00
16	4.00	8,000	4 1/2	1 1/4	16409-67-20	40.00
16	5.00	9,000	5 1/2	1	16509-67-16	72.00
16	5.00	9,000	5 1/2	1 1/4	16509-67-20	72.00
18	5.00	9,000	5 1/2	1	18509-67-16	90.00
18	5.00	9,000	5 1/2	1 1/4	18509-67-20	90.00
20	5.00	10,500	5 1/2	1	20509-67-16	110.00
20	5.00	10,500	5 1/2	1 1/4	20509-67-20	110.00
20	5.00	10,500	5 1/2	1 1/2	20509-67-24	110.00
20	5.00	10,500	5 1/2	2	20509-67-32	110.00

CONTINUED

WHEELS POLYURETHANE

BEARINGLESS (Hard Poly - 70D)

Diameter	Width	Capacity	Hub Length	Bore	Part Number	Weight
4	2.00	900	2 3/16	1 3/16	04200-63-19	3.00
4	3.25	1,530	3 1/4	1 15/16	04320-63-31	5.00
4	4.00	1,920	4 1/4	2 7/16	04400-63-39	10.00
5	2.00	1,260	2 3/16	1 3/16	05200-63-19	3.00
5	2.50	1,590	3 1/4	1 15/16	05250-63-31	7.00
5	3.00	1,836	3 1/4	1 15/16	05300-63-31	9.00
6	2.00	1,440	2 3/16	1 1/5	06200-63-19	4.50
6	2.50	1,950	3 1/4	1 15/16	06250-63-31	6.50
6	3.00	2,460	3 1/4	1 15/16	06300-63-31	9.50
8	2.00	1,860	2 3/16	1 3/16	08200-63-19	8.00
8	2.50	2,460	3 1/4	1 15/16	08250-63-31	9.50
8	3.00	3,000	3 1/4	1 15/16	08300-63-31	12.50
8	4.00	4,560	4 1/4	2 7/16	08400-63-39	20.00
10	3.00	3,600	3 1/4	1 8/9	10300-63-31	16.00
10	4.00	5,040	4 1/4	2 7/16	10400-63-39	23.00
12	3.00	4,200	3 1/4	1 15/16	12300-63-31	21.00

BEARINGLESS (Hard Poly - 70D - 1" Thick Tread)

Diameter	Width	Capacity	Hub Length	Bore	Part Number	Weight
6	3.00	2,950	3 1/4	1 15/16	06300-67-31	9.50
6	4.00	3,600	4 1/4	2 7/16	06400-67-39	17.00
6	5.00	4,400	5 1/4	2 7/16	06500-67-39	20.00
8	3.00	3,500	3 1/4	1 15/16	08300-67-31	17.00
10	3.00	4,440	3 1/4	2 7/16	10300-67-39	24.00
10	3.00	4,400	3 1/4	1 15/16	10300-67-31	24.00
10	4.00	6,000	4 1/4	2 7/16	10400-67-39	33.00
10	5.00	7,200	5 1/4	2 7/16	10500-67-39	45.00
12	3.00	4,620	3 1/4	2 7/16	12300-67-39	24.00
12	4.00	6,600	4 1/4	2 7/16	12400-67-39	30.00
12	5.00	7,800	5 1/4	2 7/16	12500-67-39	45.00
16	4.00	8,000	4 1/4	2 7/16	16400-67-39	40.00
16	5.00	9,000	5 1/4	2 7/16	16500-67-39	72.00
18	5.00	9,000	5 1/4	2 7/16	18500-67-39	90.00
20	5.00	10,500	5 1/4	2 7/16	20500-67-39	110.00

CONTINUED

All dimensions are in inches. All weights are in pounds.

WHEELS POLYURETHANE

PRECISION BALL BEARING (Hard Poly - 70D)

Diameter	Width	Capacity	Hub Length	Bore	Part Number	Weight
6	2.00	1,440	2 7/16	1/2	06202-63-08	4.50
6	3.00	2,460	3 1/2	3/4	06302-63-12	9.50
8	2.00	1,860	2 7/16	1/2	08202-63-08	8.00
8	3.00	3,000	3 1/2	3/4	08302-63-12	12.50
8	3.00	3,000	3 1/2	1	08302-63-16	12.50
10	3.00	3,600	3 1/2	3/4	10302-63-12	16.00
10	3.00	3,600	3 1/2	1	10302-63-16	16.00
12	3.00	3,540	3 1/2	3/4	12302-63-12	21.00
12	3.00	3,720	3 1/2	1	12302-63-16	21.00

PRECISION BALL BEARING (Hard Poly - 70D - 1" Thick Tread)

Diameter	Width	Capacity	Hub Length	Bore	Part Number	Weight
4	2.00	1,200	2 7/16	1/2	04202-67-08	3.00

PRECISION BALL BEARING (Hard Poly - Round Tread - 70D)

Diameter	Width	Capacity	Hub Length	Bore	Part Number	Weight
4	2.00	700	2 7/16	1/2	04202-53-08	3.00
6	2.00	1,200	2 7/16	1/2	06202-53-08	4.00
8	2.00	1,500	2 7/16	1/2	08202-53-08	5.50



BALLOON
ROUND TREAD

CONTINUED

WHEELS POLYURETHANE

STRAIGHT ROLLER BEARING (HPPT Poly - 92A)

Diameter	Width	Capacity	Hub Length	Bore	Part Number	Weight
4	2.00	1,100	2 3/16	3/4	04201-90-12	3.00
4	3.25	1,750	3 1/4	1	04321-90-16	5.00
4	3.25	1,750	3 1/4	1 1/4	04321-90-20	5.00
4	4.00	2,100	4 1/4	1 1/4	04401-90-20	10.00
4	4.00	2,100	4 1/4	1 1/2	04401-90-24	10.00
5	2.00	1,300	2 3/16	3/4	05201-90-12	3.00
5	2.50	1,600	3 1/4	1	05251-90-16	7.00
5	2.50	1,600	3 1/4	1 1/4	05251-90-20	7.00
5	3.00	1,950	3 1/4	1	05301-90-16	9.00
5	3.00	1,950	3 1/4	1 1/4	05301-90-20	9.00
6	2.00	1,525	2 3/16	3/4	06201-90-12	4.50
6	2.50	1,925	3 1/4	1	06251-90-16	6.50
6	2.50	1,925	3 1/4	1 1/4	06251-90-20	6.50
6	3.00	2,300	3 1/4	1	06301-90-16	9.50
6	3.00	2,300	3 1/4	1 1/4	06301-90-20	9.50
8	2.00	2,050	2 3/16	3/4	08201-90-12	8.00
8	2.50	2,575	3 1/4	1	08251-90-16	9.50
8	2.50	2,575	3 1/4	1 1/4	08251-90-20	9.50
8	3.00	3,100	3 1/4	1	08301-90-16	12.50
8	3.00	3,100	3 1/4	1 1/4	08301-90-20	12.50
8	4.00	4,100	4 1/4	1 1/4	08401-90-20	20.00
8	4.00	4,100	4 1/4	1 1/2	08401-90-24	20.00
10	3.00	3,450	3 1/4	1	10301-90-16	16.00
10	3.00	3,450	3 1/4	1 1/4	10301-90-20	16.00
10	4.00	4,600	4 1/4	1 1/4	10401-90-20	23.00
10	4.00	4,600	4 1/4	1 1/2	10401-90-24	23.00
12	3.00	3,800	3 1/4	1	12301-90-16	21.00
12	3.00	3,800	3 1/4	1 1/4	12301-90-20	21.00

All dimensions are in inches. All weights are in pounds.

CONTINUED

WHEELS POLYURETHANE

STRAIGHT ROLLER BEARING (HPPT Poly - 92A - 1" Thick Tread)

Diameter	Width	Capacity	Hub Length	Bore	Part Number	Weight
6	3.00	3,600	3 1/4	1	06301-95-16	9.50
6	3.00	3,600	3 1/4	1 1/4	06301-95-20	9.50
6	4.00	4,600	4 1/4	1 1/4	06401-95-20	17.00
6	4.00	4,600	4 1/4	1 1/2	06401-95-24	17.00
6	5.00	5,800	5 1/4	1 1/4	06501-95-20	20.00
6	5.00	5,800	5 1/4	1 1/2	06501-95-24	20.00
8	3.00	4,300	3 1/4	1	08301-95-16	17.00
8	3.00	4,300	3 1/4	1 1/4	08301-95-20	17.00
10	3.00	4,800	3 1/4	1	10301-95-16	24.00
10	3.00	4,800	3 1/4	1 1/4	10301-95-20	24.00
10	3.00	4,800	3 1/4	1 1/2	10301-98-24	24.00
10	4.00	6,500	4 1/4	1 1/4	10401-95-20	33.00
10	4.00	6,500	4 1/4	1 1/2	10401-95-24	33.00
10	5.00	7,900	5 1/4	1 1/4	10501-95-20	45.00
12	3.00	5,250	3 1/4	1 1/4	12301-95-20	24.00
12	3.00	5,250	3 1/4	1 1/2	12301-95-24	24.00
12	4.00	7,000	4 1/4	1 1/4	12401-95-20	30.00
12	4.00	7,000	4 1/4	1 1/2	12401-95-24	30.00
12	5.00	8,400	5 1/4	1 1/4	12501-95-20	45.00
12	5.00	8,400	5 1/4	1 1/2	12501-95-24	45.00
16	4.00	8,125	4 1/4	1 1/4	16401-95-20	40.00
16	4.00	8,125	4 1/4	1 1/2	16401-95-24	40.00
16	5.00	9,125	5 1/4	1 1/4	16501-95-20	72.00
16	5.00	9,125	5 1/4	1 1/2	16501-95-24	72.00
18	5.00	9,500	5 1/4	1 1/4	18501-95-20	90.00
18	5.00	9,500	5 1/4	1 1/2	18501-95-24	90.00
20	5.00	11,250	5 1/4	1 1/4	20501-95-20	110.00
20	5.00	11,250	5 1/4	1 1/2	20501-95-24	110.00
20	5.00	11,250	5 1/4	2	20501-95-32	110.00

CONTINUED

WHEELS POLYURETHANE

PRECISION TAPERED BEARING (HPPT Poly - 92A)

Diameter	Width	Capacity	Hub Length	Bore	Part Number	Weight
4	2.00	1,100	2 7/16	1/2	04209-90-08	3.00
4	3.25	1,750	3 1/2	3/4	04329-90-12	5.00
4	3.25	1,750	3 1/2	1	04329-90-16	5.00
4	4.00	2,100	4 1/2	1	04409-90-16	10.00
4	4.00	2,100	4 1/2	1 1/4	04409-90-20	10.00
5	2.00	1,300	2 7/16	1/2	05209-90-08	3.00
5	2.50	1,600	3 1/2	3/4	05259-90-12	7.00
5	2.50	1,600	3 1/2	1	05259-90-16	7.00
5	3.00	1,950	3 1/4	3/4	05309-90-12	9.00
5	3.00	1,950	3 1/4	1	05309-90-16	9.00
6	2.00	1,525	2 7/16	1/2	06209-90-08	4.50
6	2.00	1,525	2 7/16	3/4	06209-90-12	4.50
6	2.50	1,925	3 1/2	3/4	06259-90-12	6.50
6	2.50	1,925	3 1/2	1	06259-90-16	6.50
6	3.00	2,300	3 1/2	3/4	06309-90-12	9.50
6	3.00	2,300	3 1/2	1	06309-90-16	9.50
6	3.00	2,300	3 1/2	1 1/4	06309-90-20	9.50
8	2.00	2,050	2 7/16	3/4	08209-90-12	8.00
8	2.50	2,575	3 1/2	3/4	08259-90-12	9.50
8	2.50	2,575	3 1/2	1	08259-90-16	9.50
8	3.00	3,100	3 1/2	3/4	08309-90-12	12.50
8	3.00	3,100	3 1/2	1	08309-90-16	12.50
8	3.00	3,100	3 1/2	1 1/4	08309-90-20	12.50
8	4.00	4,100	4 1/2	1	08409-90-16	20.00
8	4.00	4,100	4 1/2	1 1/4	08409-90-20	20.00
10	3.00	3,450	3 1/2	3/4	10309-90-12	16.00
10	3.00	3,450	3 1/2	1	10309-90-16	16.00
10	3.00	3,450	3 1/2	1 1/4	10309-90-20	16.00
10	4.00	4,600	4 1/2	1	10409-90-16	23.00
10	4.00	4,600	4 1/2	1 1/4	10409-90-20	23.00
12	3.00	3,800	3 1/2	3/4	12309-90-12	21.00
12	3.00	3,800	3 1/2	1	12309-90-16	21.00
12	3.00	3,800	3 1/2	1 1/4	12309-90-20	21.00

CONTINUED

All dimensions are in inches. All weights are in pounds.

WHEELS POLYURETHANE

PRECISION TAPERED BEARING (HPPT Poly - 92A - 1" Thick Tread)

Diameter	Width	Capacity	Hub Length	Bore	Part Number	Weight
6	3.00	3,600	3 1/2	3/4	06309-95-12	9.50
6	4.00	3,600	3 1/2	1	06309-95-16	9.50
6	4.00	4,600	4 1/2	1	06409-95-16	17.00
6	4.00	4,600	4 1/2	1 1/4	06409-95-20	17.00
6	5.00	5,800	5 1/2	1	06509-95-16	20.00
6	5.00	5,800	5 1/2	1 1/4	06509-95-20	20.00
8	3.00	4,300	3 1/2	3/4	08309-95-12	17.00
8	3.00	4,300	3 1/2	1	08309-95-16	17.00
10	3.00	4,800	3 1/2	3/4	10309-95-12	24.00
10	3.00	4,800	3 1/2	1	10309-95-16	24.00
10	3.00	4,800	3 1/2	1 1/4	10309-98-20	24.00
10	4.00	6,500	4 1/2	1	10409-95-16	33.00
10	4.00	6,500	4 1/2	1 1/4	10409-95-20	33.00
12	3.00	5,250	3 1/2	1	12309-95-16	24.00
12	3.00	5,250	3 1/2	1 1/4	12309-95-20	24.00
12	4.00	7,000	4 1/2	1	12409-95-16	30.00
12	4.00	7,000	4 1/2	1 1/4	12409-95-20	30.00
12	5.00	8,400	5 1/2	1	12509-95-16	45.00
12	5.00	8,400	5 1/2	1 1/4	12509-95-20	45.00
16	4.00	8,125	4 1/2	1	16409-95-16	40.00
16	4.00	8,125	4 1/2	1 1/4	16409-95-20	40.00
16	5.00	9,125	5 1/2	1	16509-95-16	72.00
16	5.00	9,125	5 1/2	1 1/4	16509-95-20	72.00
18	5.00	9,500	5 1/2	1	18509-95-16	90.00
18	5.00	9,500	5 1/2	1 1/4	18509-95-20	90.00
20	5.00	11,250	5 1/2	1	20509-95-16	110.00
20	5.00	11,250	5 1/2	1 1/4	20509-95-20	110.00
20	5.00	11,250	5 1/2	1 1/2	20509-95-24	110.00
20	5.00	11,250	5 1/2	2	20509-95-32	110.00

CONTINUED

WHEELS POLYURETHANE

BEARINGLESS (HPPT Poly - 92A)

Diameter	Width	Capacity	Hub Length	Bore	Part Number	Weight
4	2.00	1,100	2 3/16	1 3/16	04200-90-19	3.00
4	3.25	1,750	3 1/4	1 15/16	04320-90-31	5.00
4	4.00	2,100	4 1/4	2 7/16	04400-90-39	10.00
5	2.00	1,300	2 3/16	1 3/16	05200-90-19	3.00
5	2.50	1,600	3 1/4	1 15/16	05250-90-31	7.00
5	3.00	1,950	3 1/4	1 15/16	05300-90-31	9.00
6	2.00	1,525	2 3/16	1 1/5	06200-90-19	4.50
6	2.50	1,925	3 1/4	1 15/16	06250-90-31	6.50
6	3.00	2,300	3 1/4	1 15/16	06300-90-31	9.50
8	2.00	2,050	2 3/16	1 3/16	08200-90-19	8.00
8	2.50	2,575	3 1/4	1 15/16	08250-90-31	9.50
8	3.00	3,100	3 1/4	1 15/16	08300-90-31	12.50
8	4.00	4,100	4 1/4	2 7/16	08400-90-39	20.00
10	3.00	3,450	3 1/4	1 8/9	10300-90-31	16.00
10	4.00	4,600	4 1/4	2 7/16	10400-90-39	23.00
12	3.00	3,800	3 1/4	1 15/16	12300-90-31	21.00

BEARINGLESS (HPPT Poly - 92A - 1" Thick Tread)

Diameter	Width	Capacity	Hub Length	Bore	Part Number	Weight
6	3.00	3,600	3 1/4	1 15/16	06300-95-31	9.50
6	4.00	4,600	4 1/4	2 7/16	06400-95-39	17.00
6	5.00	5,800	5 1/4	2 7/16	06500-95-39	20.00
8	3.00	4,300	3 1/4	1 15/16	08300-95-31	17.00
10	3.00	4,800	3 1/4	2 7/16	10300-98-39	24.00
10	3.00	4,800	3 1/4	1 15/16	10300-95-31	24.00
10	4.00	6,500	4 1/4	2 7/16	10400-95-39	33.00
10	5.00	7,900	5 1/4	2 7/16	10500-95-39	45.00
12	3.00	5,250	3 1/4	2 7/16	12300-95-39	24.00
12	4.00	7,000	4 1/4	2 7/16	12400-95-39	30.00
12	5.00	8,400	5 1/4	2 7/16	12500-95-39	45.00
16	4.00	8,125	4 1/4	2 7/16	16400-95-39	40.00
16	5.00	9,125	5 1/4	2 7/16	16500-95-39	72.00
18	5.00	9,500	5 1/4	2 7/16	18500-95-39	90.00
20	5.00	11,250	5 1/4	2 7/16	20500-95-39	110.00

CONTINUED

All dimensions are in inches. All weights are in pounds.

WHEELS POLYURETHANE

PRECISION BALL BEARING (HPPT Poly - 92A)

Diameter	Width	Capacity	Hub Length	Bore	Part Number	Weight
5	2.00	1,300	2 7/16	1/2	05202-90-08	3.00
6	2.00	1,525	2 7/16	1/2	06202-90-08	4.50
6	3.00	2,300	3 1/2	3/4	06302-90-12	9.50
8	2.00	2,050	2 7/16	1/2	08202-90-08	8.00
8	2.50	2,575	3 1/2	3/4	08252-90-12	9.50
8	3.00	3,100	3 1/2	3/4	08302-90-12	12.50
8	3.00	3,100	3 1/2	1	08302-90-16	12.50
10	3.00	3,450	3 1/2	3/4	10302-90-12	16.00
10	3.00	3,450	3 1/2	1	10302-90-16	16.00
12	3.00	3,540	3 1/2	3/4	12302-90-12	21.00
12	3.00	3,720	3 1/2	1	12302-90-16	21.00
12	3.00	3,800	3 1/2	1 1/4	12302-90-20	21.00

PRECISION BALL BEARING (HPPT Poly - 92A - 1" Thick Tread)

Diameter	Width	Capacity	Hub Length	Bore	Part Number	Weight
4	2.00	1,400	2 7/16	1/2	04202-95-08	3.00

PRECISION BALL BEARING (HPPT Poly - Round Tread - 92A)

Diameter	Width	Capacity	Hub Length	Bore	Part Number	Weight
12	1.75	1,900	3 1/2	3/4	12172-90-12	18.00



BALLOON
ROUND TREAD

CONTINUED

WHEELS POLYURETHANE

STRAIGHT ROLLER BEARING (T/R-95)

Diameter	Width	Capacity	Hub Length	Bore	Part Number	Weight
4	2.00	1,000	2 3/16	3/4	04201-91-12	3.00
4	3.25	1,575	3 1/4	1	04321-91-16	5.00
4	3.25	1,575	3 1/4	1 1/4	04321-91-20	5.00
4	4.00	1,890	4 1/4	1 1/4	04401-91-20	10.00
4	4.00	1,890	4 1/4	1 1/2	04401-91-24	10.00
5	2.00	1,170	2 3/16	3/4	05201-91-12	3.00
5	2.50	1,440	3 1/4	1	05251-91-16	7.00
5	2.50	1,440	3 1/4	1 1/4	05251-91-20	7.00
5	3.00	1,755	3 1/4	1	05301-91-16	9.00
5	3.00	1,755	3 1/4	1 1/4	05301-91-20	9.00
6	2.00	1,400	2 3/16	3/4	06201-91-12	4.50
6	2.50	1,800	3 1/4	1	06251-91-16	6.50
6	2.50	1,800	3 1/4	1 1/4	06251-91-20	6.50
6	3.00	2,070	3 1/4	1	06301-91-16	9.50
6	3.00	2,070	3 1/4	1 1/4	06301-91-20	9.50
8	2.00	1,800	2 3/16	3/4	08201-91-12	8.00
8	2.50	2,300	3 1/4	1	08251-91-16	9.50
8	2.50	2,300	3 1/4	1 1/4	08251-91-20	9.50
8	3.00	2,800	3 1/4	1	08301-91-16	12.50
8	3.00	2,800	3 1/4	1 1/4	08301-91-20	12.50
8	4.00	3,700	4 1/4	1 1/4	08401-91-20	20.00
8	4.00	3,700	4 1/4	1 1/2	08401-91-24	20.00
10	3.00	3,100	3 1/4	1	10301-91-16	16.00
10	3.00	3,100	3 1/4	1 1/4	10301-91-20	16.00
10	4.00	4,140	4 1/4	1 1/4	10401-91-20	23.00
10	4.00	4,140	4 1/4	1 1/2	10401-91-24	23.00
12	3.00	3,400	3 1/4	1	12301-91-16	21.00
12	3.00	3,400	3 1/4	1 1/4	12301-91-20	21.00

All dimensions are in inches. All weights are in pounds.

CONTINUED

WHEELS POLYURETHANE

STRAIGHT ROLLER BEARING (T/R-95 - 1" Thick Tread)

Diameter	Width	Capacity	Hub Length	Bore	Part Number	Weight
6	3.00	3,240	3 1/4	1	06301-96-16	9.50
6	3.00	3,240	3 1/4	1 1/4	06301-96-20	9.50
6	4.00	4,140	4 1/4	1 1/4	06401-96-20	17.00
6	4.00	4,140	4 1/4	1 1/2	06401-96-24	17.00
6	5.00	5,200	5 1/4	1 1/4	06501-96-20	20.00
6	5.00	5,200	5 1/4	1 1/2	06501-96-24	20.00
8	3.00	3,900	3 1/4	1	08301-96-16	17.00
8	3.00	3,900	3 1/4	1 1/4	08301-96-20	17.00
10	3.00	4,300	3 1/4	1	10301-96-16	24.00
10	3.00	4,300	3 1/4	1 1/4	10301-96-20	24.00
10	3.00	4,300	3 1/4	1 1/2	10301-96-24	24.00
10	4.00	5,850	4 1/4	1 1/4	10401-96-20	33.00
10	4.00	5,850	4 1/4	1 1/2	10401-96-24	33.00
10	5.00	7,100	5 1/4	1 1/4	10501-96-20	45.00
12	3.00	4,725	3 1/4	1 1/4	12301-96-20	24.00
12	3.00	4,725	3 1/4	1 1/2	12301-96-24	24.00
12	4.00	6,300	4 1/4	1 1/4	12401-96-20	30.00
12	4.00	6,300	4 1/4	1 1/2	12401-96-24	30.00
12	5.00	7,560	5 1/4	1 1/4	12501-96-20	45.00
12	5.00	7,560	5 1/4	1 1/2	12501-96-24	45.00
16	4.00	7,300	4 1/4	1 1/4	16401-96-20	40.00
16	4.00	7,300	4 1/4	1 1/2	16401-96-24	40.00
16	5.00	8,200	5 1/4	1 1/4	16501-96-20	72.00
16	5.00	8,200	5 1/4	1 1/2	16501-96-24	72.00
18	5.00	8,550	5 1/4	1 1/4	18501-96-20	90.00
18	5.00	8,550	5 1/4	1 1/2	18501-96-24	90.00
20	5.00	10,125	5 1/4	1 1/4	20501-96-20	110.00
20	5.00	10,125	5 1/4	1 1/2	20501-96-24	110.00
20	5.00	10,125	5 1/4	2	20501-96-32	110.00

CONTINUED

WHEELS POLYURETHANE

PRECISION TAPERED BEARING (T/R-95)

Diameter	Width	Capacity	Hub Length	Bore	Part Number	Weight
4	2.00	1,000	2 7/16	1/2	04209-91-08	3.00
4	3.25	1,575	3 1/2	3/4	04329-91-12	5.00
4	3.25	1,575	3 1/2	1	04329-91-16	5.00
4	4.00	1,890	4 1/2	1	04409-91-16	10.00
4	4.00	1,890	4 1/2	1 1/4	04409-91-20	10.00
5	2.00	1,170	2 7/16	1/2	05209-91-08	3.00
5	2.50	1,440	3 1/2	3/4	05259-91-12	7.00
5	2.50	1,440	3 1/2	1	05259-91-16	7.00
5	3.00	1,755	3 1/4	3/4	05309-91-12	9.00
5	3.00	1,755	3 1/4	1	05309-91-16	9.00
6	2.00	1,400	2 7/16	1/2	06209-91-08	4.50
6	2.00	1,400	2 7/16	3/4	06209-91-12	4.50
6	2.50	1,800	3 1/2	3/4	06259-91-12	6.50
6	2.50	1,800	3 1/2	1	06259-91-16	6.50
6	3.00	2,070	3 1/2	3/4	06309-91-12	9.50
6	3.00	2,070	3 1/2	1	06309-91-16	9.50
6	3.00	2,070	3 1/2	1 1/4	06309-91-20	9.50
8	2.00	1,800	2 7/16	3/4	08209-91-12	8.00
8	2.50	2,300	3 1/2	3/4	08259-91-12	9.50
8	2.50	2,300	3 1/2	1	08259-91-16	9.50
8	3.00	2,800	3 1/2	3/4	08309-91-12	12.50
8	3.00	2,800	3 1/2	1	08309-91-16	12.50
8	3.00	2,800	3 1/2	1 1/4	08309-91-20	12.50
8	4.00	3,700	4 1/2	1	08409-91-19	20.00
8	4.00	3,700	4 1/2	1 1/4	08409-91-20	20.00
10	3.00	3,100	3 1/2	3/4	10309-91-12	16.00
10	3.00	3,100	3 1/2	1	10309-91-16	16.00
10	3.00	3,100	3 1/2	1 1/4	10309-91-20	16.00
10	4.00	4,140	4 1/2	1	10409-91-16	23.00
10	4.00	4,140	4 1/2	1 1/4	10409-91-20	23.00
12	3.00	3,400	3 1/2	3/4	12309-91-12	21.00
12	3.00	3,400	3 1/2	1	12309-91-16	21.00
12	3.00	3,400	3 1/2	1 1/4	12309-91-20	21.00

CONTINUED

All dimensions are in inches. All weights are in pounds.

WHEELS POLYURETHANE

PRECISION TAPERED BEARING (T/R-95 - 1" Thick Tread)

Diameter	Width	Capacity	Hub Length	Bore	Part Number	Weight
6	3.00	3,240	3 1/2	3/4	06309-96-12	9.50
6	4.00	3,240	3 1/2	1	06309-96-16	9.50
6	4.00	4,140	4 1/2	1	06409-96-16	17.00
6	4.00	4,140	4 1/2	1 1/4	06409-96-20	17.00
6	5.00	5,200	5 1/2	1	06509-96-16	20.00
6	5.00	5,200	5 1/2	1 1/4	06509-96-20	20.00
8	3.00	3,900	3 1/2	3/4	08309-96-12	17.00
8	3.00	3,900	3 1/2	1	08309-96-16	17.00
10	3.00	4,300	3 1/2	3/4	10309-96-12	24.00
10	3.00	4,300	3 1/2	1	10309-96-16	24.00
10	3.00	4,300	3 1/2	1 1/4	10309-96-20	24.00
10	4.00	5,850	4 1/2	1	10409-96-16	33.00
10	4.00	5,850	4 1/2	1 1/4	10409-96-20	33.00
12	3.00	4,725	3 1/2	1	12309-96-16	24.00
12	3.00	4,725	3 1/2	1 1/4	12309-96-20	24.00
12	4.00	6,300	4 1/2	1	12409-96-16	30.00
12	4.00	6,300	4 1/2	1 1/4	12409-96-20	30.00
12	5.00	7,560	5 1/2	1	12509-96-16	45.00
12	5.00	7,560	5 1/2	1 1/4	12509-96-20	45.00
16	4.00	7,300	4 1/2	1	16409-96-16	40.00
16	4.00	7,300	4 1/2	1 1/4	16409-96-20	40.00
16	5.00	8,200	5 1/2	1	16509-96-16	72.00
16	5.00	8,200	5 1/2	1 1/4	16509-96-20	72.00
18	5.00	8,550	5 1/2	1	18509-96-16	90.00
18	5.00	8,550	5 1/2	1 1/4	18509-96-20	90.00
20	5.00	10,125	5 1/2	1	20509-96-16	110.00
20	5.00	10,125	5 1/2	1 1/4	20509-96-20	110.00
20	5.00	10,125	5 1/2	1 1/2	20509-96-24	110.00
20	5.00	10,125	5 1/2	2	20509-96-32	110.00

CONTINUED

WHEELS POLYURETHANE

BEARINGLESS (T/R-95)

Diameter	Width	Capacity	Hub Length	Bore	Part Number	Weight
4	2.00	1,000	2 3/16	1 3/16	04200-91-19	3.00
4	3.25	1,575	3 1/4	1 15/16	04320-91-31	5.00
4	4.00	1,890	4 1/4	2 7/16	04400-91-39	10.00
5	2.00	1,170	2 3/16	1 3/16	05200-91-19	3.00
5	2.50	1,440	3 1/4	1 15/16	05250-91-31	7.00
5	3.00	1,755	3 1/4	1 15/16	05300-91-31	9.00
6	2.00	1,400	2 3/16	1 1/5	06200-91-19	4.50
6	2.50	1,800	3 1/4	1 15/16	06250-91-31	6.50
6	3.00	2,070	3 1/4	1 15/16	06300-91-31	9.50
8	2.00	1,800	2 3/16	1 3/16	08200-91-19	8.00
8	2.50	2,300	3 1/4	1 15/16	08250-91-31	9.50
8	3.00	2,800	3 1/4	1 15/16	08300-91-31	12.50
8	4.00	3,700	4 1/4	2 7/16	08400-91-39	20.00
10	3.00	3,100	3 1/4	1 8/9	10300-91-31	16.00
10	4.00	4,140	4 1/4	2 7/16	10400-91-39	23.00
12	3.00	3,400	3 1/4	1 15/16	12300-91-31	21.00

BEARINGLESS (T/R-95 - 1" Thick Tread)

Diameter	Width	Capacity	Hub Length	Bore	Part Number	Weight
6	3.00	3,240	3 1/4	1 15/16	06300-96-31	9.50
6	4.00	4,140	4 1/4	2 7/16	06400-96-39	17.00
6	5.00	5,200	5 1/4	2 7/16	06500-96-39	20.00
8	3.00	3,900	3 1/4	1 15/16	08300-96-31	17.00
10	3.00	4,300	3 1/4	2 7/16	10300-96-39	24.00
10	3.00	4,300	3 1/4	1 15/16	10300-96-31	24.00
10	4.00	5,850	4 1/4	2 7/16	10400-96-39	33.00
10	5.00	7,100	5 1/4	2 7/16	10500-96-39	45.00
12	3.00	4,725	3 1/4	2 7/16	12300-96-39	24.00
12	4.00	6,300	4 1/4	2 7/16	12400-96-39	30.00
12	5.00	7,560	5 1/4	2 7/16	12500-96-39	45.00
16	4.00	7,300	4 1/4	2 7/16	16400-96-39	40.00
16	5.00	8,200	5 1/4	2 7/16	16500-96-39	72.00
18	5.00	8,550	5 1/4	2 7/16	18500-96-39	90.00
20	5.00	10,125	5 1/4	2 7/16	20500-96-39	110.00

CONTINUED

All dimensions are in inches. All weights are in pounds.

WHEELS POLYURETHANE

PRECISION BALL BEARING (T/R-95 - 1" Thick Tread)

Diameter	Width	Capacity	Hub Length	Bore	Part Number	Weight
4	2.00	1,260	2 7/16	1/2	04202-96-08	3.00

PRECISION BALL BEARING (Round Tread - T/R-95)

Diameter	Width	Capacity	Hub Length	Bore	Part Number	Weight
4	2.00	600	2 7/16	1/2	04202-56-08	3.00
6	2.00	1,100	2 7/16	1/2	06202-56-08	4.00
8	2.00	1,400	2 7/16	1/2	08202-56-08	5.50
12	1.75	1,600	3 1/2	3/4	12172-91-12	18.00



BALLOON
ROUND TREAD

PRECISION BALL BEARING (Round Tread - ErgoTread Poly)

Diameter	Width	Capacity	Hub Length	Bore	Part Number	Weight
4	2.00	475	2 7/16	1/2	04202-43-08	3.00
6	2.00	760	2 7/16	1/2	06202-43-08	4.00
8	2.00	950	2 7/16	1/2	08202-43-08	5.50



BALLOON
ROUND TREAD

All dimensions are in inches. All weights are in pounds.

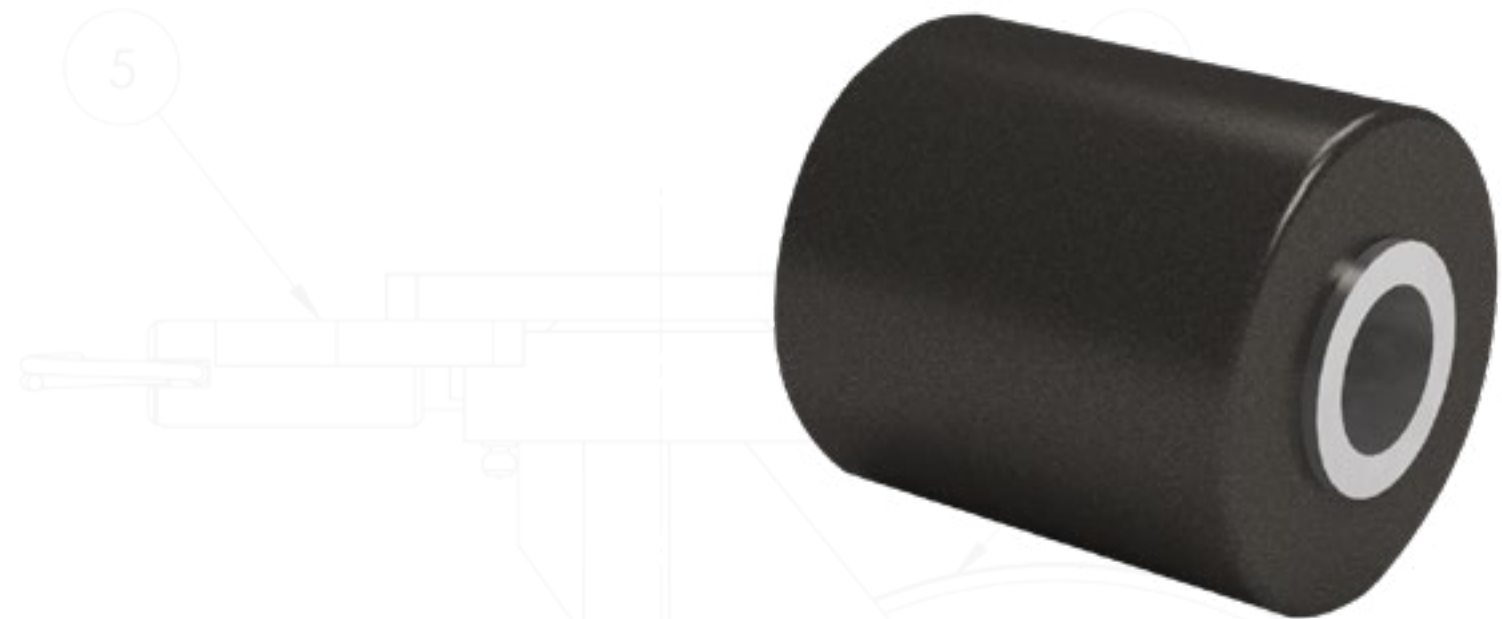

WHEELS
NYTEC-MD

WHEELS NYTEC-MD



MAXIMUM CAPACITY

9,360 lbs.

FEATURES

NyTec-MD is a nylon filled material which provides a high load capacity, floor protective wheel. Wheel capacities approach those of similar cast iron and steel wheels. NyTec-MD material is resistant to most harsh environments. The non-abrasive and vibration dampening material actually provides a quieter operation when compared to steel or cast iron wheels. When used in wet environments, plain bore NyTec-MD wheels can be used as the material is self lubricating. NyTec-MD wheels are offered with precision tapered, precision ball, and straight roller bearings. For special applications, contact the factory.

APPLICATIONS

Caster Concepts' NyTec-MD materials are widely used as idlers and support wheels in many large turn table applications. They provide a high load capacity while also offering a material that will provide reduced noise when compared to steel.

BENEFITS

NyTec-HS is a heat stabilized material which is suited for higher loads, with thermal stability up to 260 degrees Fahrenheit. This material is excellent in applications where continual use is necessary. Wheels manufactured in NyTec-HS material have been tested under load to 2 million revolutions and have shown little or no wear to the tread surface.

WHEELS NYTEC-MD

STRAIGHT ROLLER BEARING

Diameter	Width	Capacity	Hub Length	Bore	Part Number
3	2.19	1,560	2 7/16	1/2	03201-39-12
3	3.25	2,340	3 1/2	1	03301-39-16*
3	3.25	2,340	3 1/4	1 1/4	03301-39-20
4	2.19	2,080	2 7/16	1/2	04201-39-12
4	3.25	3,120	3 1/2	1	04301-39-16*
4	3.25	3,120	3 1/2	1 1/4	04301-39-20*
4	4.25	4,160	4 1/2	1 1/4	04401-39-20*
4	4.25	4,160	4 1/4	1 1/2	04401-39-24
6	2.19	3,120	2 7/16	1/2	06201-39-12
6	3.25	4,680	3 1/2	1	06301-39-16*
6	3.25	4,680	3 1/2	1 1/4	06301-39-20*
6	4.25	6,240	4 1/2	1 1/4	06401-39-20*
6	4.25	6,240	4 1/4	1 1/2	06401-39-24
6	5.25	7,800	5 1/2	1 1/4	06501-39-20*
6	5.25	7,800	5 1/4	1 1/2	06501-39-24
8	2.19	4,160	2 7/16	1/2	08201-39-12
8	3.25	6,240	3 1/2	1	08301-39-16*
8	3.25	6,240	3 1/2	1 1/4	08301-39-20*
8	4.25	8,320	4 1/2	1 1/4	08401-39-20*
8	4.25	8,320	4 1/4	1 1/2	08401-39-24
8	5.25	10,400	5 1/2	1 1/4	08501-39-20*
8	5.25	10,400	5 1/4	1 1/2	08501-39-24
10	3.25	7,800	3 1/2	1	10301-39-16*
10	3.25	7,800	3 1/2	1 1/4	10301-39-20*
10	4.25	10,400	4 1/2	1 1/4	10401-39-20*
10	4.25	10,400	4 1/4	1 1/2	10401-39-24
10	5.25	13,000	5 1/2	1 1/4	10501-39-20*
10	5.25	13,000	5 1/4	1 1/2	10501-39-24
12	3.25	11,440	3 1/2	1	12301-39-16*
12	3.25	11,440	3 1/2	1 1/4	12301-39-20*
12	4.25	12,480	3 1/2	1 1/4	12401-39-20*
12	4.25	12,480	3 1/4	1 1/2	12401-39-24
12	5.25	15,600	5 1/2	1 1/4	12501-39-20*
12	5.25	15,600	5 1/2	1 1/2	12501-39-24

* These wheels have .25 shorter hub length.
All dimensions are in inches. All weights are in pounds.

CONTINUED

WHEELS NYTEC-MD

PRECISION TAPERED BEARING

Diameter	Width	Capacity	Hub Length	Bore	Part Number
3	2.19	1,560	2 7/16	1/2	03209-39-08
3	3.25	2,340	3 1/2	1	03309-39-16
3	4.25	2,340	4 1/2	3/4	03409-39-12
3	4.25	3,120	4 1/2	1	03409-39-16
4	2.19	2,080	2 7/16	1/2	04209-39-08
4	3.25	3,120	3 1/2	3/4	04309-39-12
4	3.25	3,120	3 1/2	1	04309-39-16
4	3.25	3,120	3 1/2	1 1/4	04309-39-20
4	4.25	4,160	4 1/2	3/4	04409-39-12
4	4.25	4,160	4 1/2	1	04409-39-16
4	4.25	4,160	4 1/2	1 1/4	04409-39-20
6	2.19	3,120	2 7/16	5 1/2	06209-39-08
6	3.25	4,680	3 1/2	5 1/2	06309-39-12
6	3.25	4,680	3 1/2	1	06309-39-16
6	3.25	4,680	3 1/2	1 1/4	06309-39-20
6	4.25	6,240	4 1/2	1	06409-39-16
6	4.25	6,240	4 1/2	1 1/4	06409-39-20
6	5.25	7,800	5 1/2	1	06509-39-16
6	5.25	7,800	5 1/2	1 1/4	06509-39-20
8	2.19	4,160	2 7/16	1/2	08209-39-08
8	3.25	6,240	3 1/2	3/4	08309-39-12
8	3.25	6,240	3 1/2	1	08309-39-16
8	3.25	6,240	3 1/2	1 1/4	08309-39-20
8	4.25	8,320	4 1/2	1	08409-39-16
8	4.25	8,320	4 1/2	1 1/4	08409-39-20
8	5.25	10,400	5 1/2	1	08509-39-16
8	5.25	10,400	5 1/2	1 1/4	08509-39-20
10	3.25	7,800	3 1/2	3/4	10309-39-12
10	3.25	7,800	3 1/2	1	10309-39-16
10	3.25	7,800	3 1/2	1 1/4	10309-39-20
10	4.25	10,400	4 1/2	1	10409-39-16
10	4.25	10,400	4 1/2	1 1/4	10409-39-20
10	5.25	13,000	5 1/2	1	10509-39-16
10	5.25	13,000	5 1/2	1 1/4	10509-39-20

CONTINUED

WHEELS NYTEC-MD

PRECISION TAPERED BEARING

Diameter	Width	Capacity	Hub Length	Bore	Part Number
12	3.25	11,440	3 1/2	3/4	12309-39-12
12	3.25	11,440	3 1/2	1	12309-39-16
12	3.25	11,440	3 1/2	1 1/4	12309-39-20
12	4.25	12,480	3 1/2	1	12409-39-16
12	4.25	12,480	3 1/2	1 1/4	12409-39-20
12	5.25	15,600	5 1/2	1	12509-39-16
12	5.25	15,600	5 1/2	1 1/4	12509-39-20
12	6.25	18,720	6 1/2	1	12609-39-16
12	6.25	18,720	6 1/2	1 1/4	12609-39-20

PRECISION BALL BEARING

Diameter	Width	Capacity	Hub Length	Bore	Part Number
3	2.19	1,560	2 7/16	1/2	03202-39-08
3	3.25	2,340	3 1/2	1	03302-39-16
3	4.25	3,120	4 1/2	3/4	03402-39-12
3	4.25	3,120	4 1/2	1	03402-39-16
4	2.19	2,080	2 7/16	1/2	04202-39-08
4	3.25	3,120	3 1/2	3/4	04302-39-12
4	3.25	3,120	3 1/2	1	04302-39-16
4	3.25	3,120	3 1/2	1 1/4	04302-39-20
4	4.25	3,540	4 1/2	3/4	04402-39-12
4	4.25	3,720	4 1/2	1	04402-39-16
4	4.25	4,160	4 1/2	1 1/4	04402-39-20
6	2.19	2,160	2 7/16	5 1/2	06202-39-08
6	3.25	3,540	3 1/2	5 1/2	06302-39-12
6	3.25	3,720	3 1/2	1	06302-39-16
6	3.25	4,630	3 1/2	1 1/4	06302-39-20
6	4.25	3,720	4 1/2	1	06402-39-16
6	4.25	4,630	4 1/2	1 1/4	06402-39-20
6	5.25	3,720	5 1/2	1	06502-39-16
6	5.25	4,630	5 1/2	1 1/4	06502-39-20

* These wheels have .25 shorter hub length.
All dimensions are in inches. All weights are in pounds.

CONTINUED

WHEELS NYTEC-MD

PRECISION BALL BEARING

Diameter	Width	Capacity	Hub Length	Bore	Part Number
8	2.19	2,160	2 7/16	1/2	08202-39-08
8	3.25	3,540	3 1/2	3/4	08302-39-12
8	3.25	3,720	3 1/2	1	08302-39-16
8	3.25	4,630	3 1/2	1 1/4	08302-39-20
8	4.25	3,720	4 1/2	1	08402-39-16
8	4.25	4,630	4 1/2	1 1/4	08402-39-20
8	5.25	3,720	5 1/2	1	08502-39-16
8	5.25	4,630	5 1/2	1 1/4	08502-39-20
10	3.25	3,540	3 1/2	3/4	10302-39-12
10	3.25	3,720	3 1/2	1	10302-39-16
10	3.25	4,630	3 1/2	1 1/4	10302-39-20
10	4.25	3,720	4 1/2	1	10402-39-16
10	4.25	4,630	4 1/2	1 1/4	10402-39-20
10	5.25	3,720	5 1/2	1	10502-39-16
10	5.25	4,630	5 1/2	1 1/4	10502-39-20
12	3.25	3,540	3 1/2	3/4	12302-39-12
12	3.25	3,720	3 1/2	1	12302-39-16
12	3.25	4,630	3 1/2	1 1/4	12302-39-20
12	4.25	3,720	3 1/2	1	12402-39-16
12	4.25	4,630	3 1/2	1 1/4	12402-39-20
12	5.25	3,720	5 1/2	1	12502-39-16
12	5.25	4,630	5 1/2	1 1/4	12502-39-20
12	6.25	3,720	6 1/2	1	12602-39-16
12	6.25	4,630	6 1/2	1 1/4	12602-39-20

* These wheels have .25 shorter hub length.
All dimensions are in inches. All weights are in pounds.



WHEELS
KEYWAY

WHEELS KEYWAY



FEATURES

A wide variety of keyway drive wheels are available. Keyway drive wheels are used in various power transmission applications. The keyways are cut to fit a keywayed shaft and are held in place with two set screws. One set screw is placed over the key and one at 90 degrees to the keyway. The most popular models in rubber and soft polyurethane are shown in the charts. Keyway wheels are manufactured in other materials, forged steel or cast iron, are available. Check the wheel widths on the chart and select the appropriate bushing. Quotes for specific requirements is also readily available.

MAXIMUM CAPACITY

3,000 lbs.

BUSHINGS FOR MOTORIZED / KEYWAY WHEELS

Part	Inner Diameter	Outer Diameter	Length	Keyway	Wheel Width
KWAA	0.5	1.19	2.44	0.125	2"
KWBB	0.75	1.19	2.44	0.188	2"
KWA	0.5	1.94	3.25	0.125	2-1/2" or 3"
KWB	0.75	1.94	3.25	0.188	2-1/2" or 3"
KWC	1	1.94	3.25	0.25	2-1/2" or 3"
KWD	1.25	1.94	3.25	0.25	2-1/2" or 3"
KWE	1.5	2.44	4.25	0.375	4"
KWEE	1.5	2.44	5.25	0.375	5"

WHEELS KEYWAY

BEARINGLESS

Diameter	Width	Capacity	Hub Length	Bore	Keyway Size	Part Number
3	2.00	300	3 1/4 offset	1/2	1/8 x 1/16	03200-70-08-KWA
3	2.00	300	3 1/4 offset	3/4	3/16 x 3/32	03200-70-12-KWB
3	2.00	300	3 1/4 offset	1/2	1/8 x 1/16	03200-61-08-KWA
3	2.00	300	3 1/4 offset	3/4	3/16 x 3/32	03200-61-12-KWB
4	2.00	350	3 1/4 offset	1/2	1/8 x 1/16	04200-70-08-KWA
4	2.00	350	3 1/4 offset	3/4	3/16 x 3/32	04200-70-12-KWB
4	2.00	350	3 1/4 offset	1/2	1/8 x 1/16	04200-66-08-KWA
4	2.00	350	3 1/4 offset	3/4	3/16 x 3/32	04200-66-12-KWB
5	2.00	400	2 3/16	1/2	1/8 x 1/16	05200-70-08-KWAA
5	2.00	400	2 3/16	3/4	3/16 x 3/32	05200-70-12-KWBB
5	2.00	400	2 3/16	1/2	1/8 x 1/16	05200-61-08-KWAA
5	2.00	400	2 3/16	3/4	3/16 x 3/32	05200-61-12-KWBB
6	2.00	425	2 3/16	1/2	1/8 x 1/16	06200-70-08-KWAA
6	2.00	425	2 3/16	3/4	3/16 x 3/32	06200-70-12-KWBB
6	3.00	500	3 1/4	1/2	1/8 x 1/16	06300-70-08-KWA
6	3.00	500	3 1/4	3/4	3/16 x 3/32	06300-70-12-KWB
6	3.00	500	3 1/4	1	1/4 x 1/8	06300-70-16-KWC
6	3.00	500	3 1/4	1 1/4	1/4 x 1/8	06300-70-20-KWD
6	2.00	640	2 3/16	1/2	1/8 x 1/16	06200-61-08-KWAA
6	2.00	640	2 3/16	3/4	3/16 x 3/32	06200-61-12-KWBB
6	3.00	800	3 1/4	1/2	1/8 x 1/16	06300-66-08-KWA
6	3.00	800	3 1/4	3/4	3/16 x 3/32	06300-66-12-KWB
6	3.00	1,600	3 1/4	1	1/4 x 1/8	06300-66-16-KWC
6	3.00	1,600	3 1/4	1 1/4	1/4 x 1/8	06300-66-20-KWD
8	2.00	500	2 3/16	1/2	1/8 x 1/16	08200-70-08-KWAA
8	2.00	500	2 3/16	3/4	3/16 x 3/32	08200-70-12-KWBB
8	3.00	850	3 1/4	1/2	1/8 x 1/16	08300-70-08-KWA
8	3.00	850	3 1/4	3/4	3/16 x 3/32	08300-70-12-KWB
8	3.00	850	3 1/4	1	1/4 x 1/8	08300-70-16-KWC
8	3.00	850	3 1/4	1 1/4	1/4 x 1/8	08300-70-20-KWD
8	2.00	500	2 3/16	1/2	1/8 x 1/16	08200-61-08-KWAA
8	2.00	500	2 3/16	3/4	3/16 x 3/32	08200-61-12-KWBB
8	3.00	800	3 1/4	1/2	1/8 x 1/16	08300-66-08-KWA
8	3.00	800	3 1/4	3/4	3/16 x 3/32	08300-66-12-KWB
8	3.00	1,600	3 1/4	1	1/4 x 1/8	08300-66-16-KWC
8	3.00	1,600	3 1/4	1 1/4	1/4 x 1/8	08300-66-20-KWD

CONTINUED

All dimensions are in inches. All weights are in pounds.

WHEELS KEYWAY

BEARINGLESS

Diameter	Width	Capacity	Hub Length	Bore	Keyway Size	Part Number
10	3.00	800	3 1/4	1/2	1/8 x 1/16	10300-70-08-KWA
10	3.00	800	3 1/4	3/4	3/16 x 3/32	10300-70-12-KWB
10	3.00	1,000	3 1/4	1	1/4 x 1/8	10300-70-16-KWC
10	3.00	1,000	3 1/4	1 1/4	1/4 x 1/8	10300-70-20-KWD
10	4.00	1,400	4 1/4	1 1/2	3/8 x 3/16	10400-70-24-KWE
10	3.00	800	3 1/4	3/4	3/16 x 3/32	10300-66-12-KWB
10	3.00	1,600	3 1/4	1	1/4 x 1/8	10300-66-16-KWC
10	3.00	1,600	3 1/4	1 1/4	1/4 x 1/8	10300-66-20-KWD
10	4.00	2,500	4 1/4	1 1/2	3/8 x 3/16	10400-66-24-KWE
10	5.00	2,500	5 1/4	1 1/2	3/8 x 3/16	10500-66-24-KWEE
12	4.00	3,000	4 1/4	1 1/2	3/8 x 3/16	12400-66-24-KWE

All dimensions are in inches. All weights are in pounds.

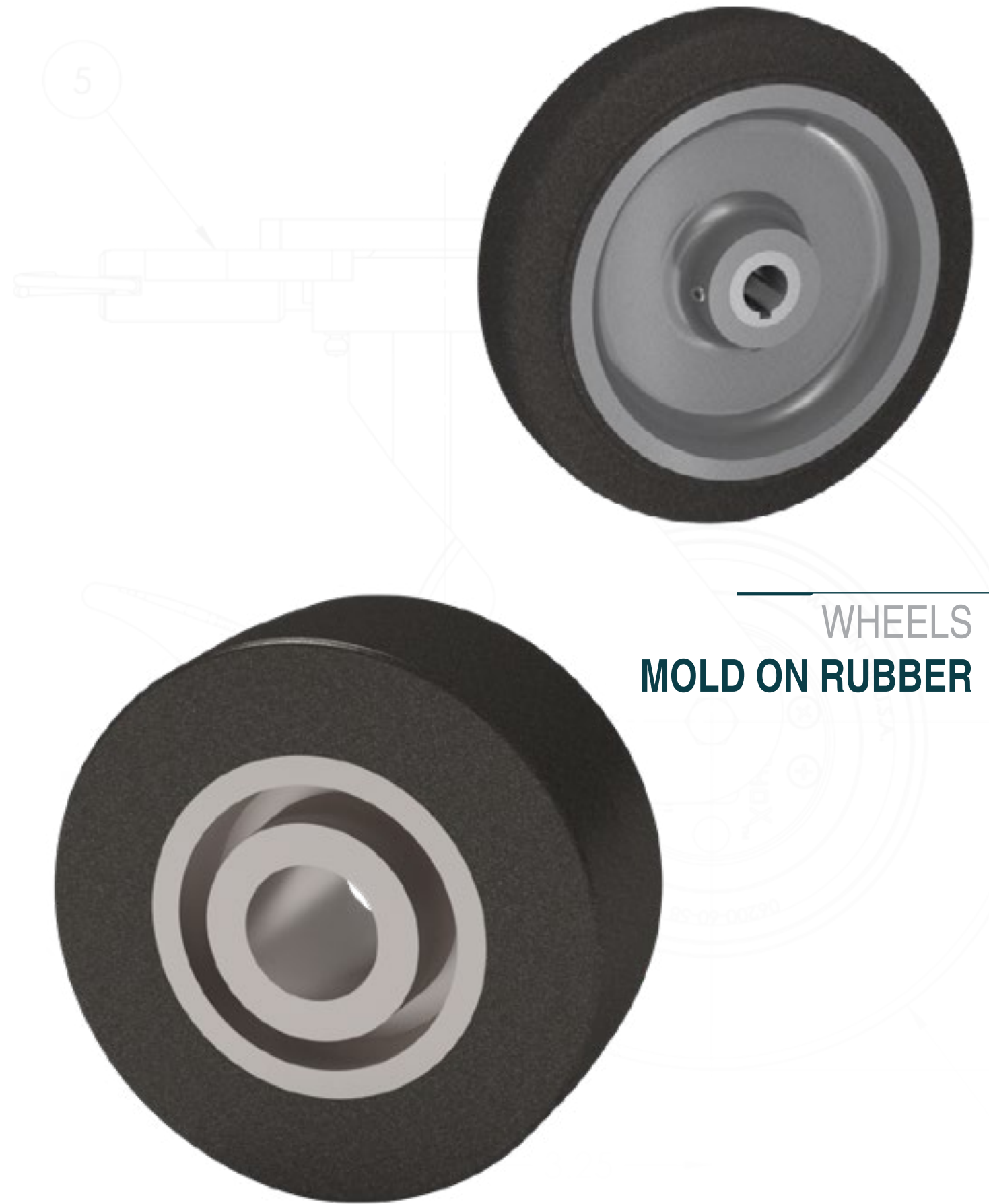

WHEELS MOLD ON RUBBER

WHEELS MOLD ON RUBBER

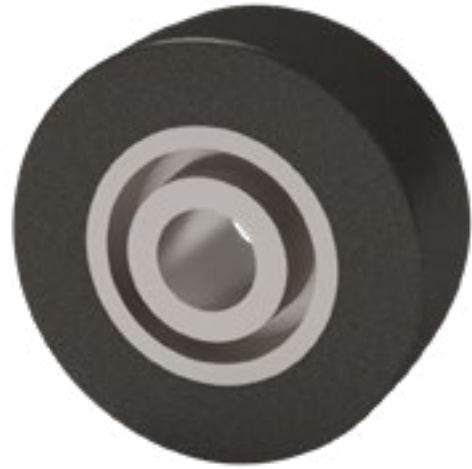

MAXIMUM CAPACITY

3,000 lbs.

FEATURES

Bearings: Delrin, oilite, roller, precision ball, tapered.

Temperature: Maximum to 180° F

Durometer: 70 Durometer Shore A

Standard: All 1-1/2" and 2" width wheels with 3/4" roller bearings are supplied with 1/2" spanner bushing.

APPLICATIONS

Excellent for moist and wet environments, food service equipment, small waste bins, factory use, platform trucks and hotel equipment.

BENEFITS

Caster Concepts offers the highest quality domestic Mold On Rubber wheels. Our mold on rubber wheels consist of a soft black, 70 durometer rubber tread permanently bonded Class 30 gray iron centers. Mold on rubber wheels provide excellent floor protection, a cushioned and quiet ride for the product being transported, and they absorb shock and vibration.

WHEELS MOLD ON RUBBER

STRAIGHT ROLLER BEARING

Diameter	Width	Capacity	Hub Length	Bore	Part Number	Weight
5	2.00	400	2 3/16	3/4	05201-70-12	2.50
6	2.00	425	2 3/16	3/4	06201-70-12	4.50
6	2.50	550	3 1/4	1	06251-70-16	6.50
6	2.50	550	3 1/4	1 1/4	06251-70-20	6.50
6	3.00	700	3 1/4	1	06301-70-16	9.50
6	3.00	700	3 1/4	1 1/4	06301-70-20	9.50
8	2.00	500	2 3/16	3/4	08201-70-12	7.00
8	2.50	700	3 1/4	1	08251-70-16	9.50
8	2.50	700	3 1/4	1 1/4	08251-70-20	9.50
8	3.00	850	3 1/4	1	08301-70-16	12.50
8	3.00	850	3 1/4	1 1/4	08301-70-20	12.50
10	2.50	800	3 1/4	1	10251-70-16	13.00
10	2.50	800	3 1/4	1 1/4	10251-70-20	13.00
10	3.00	1,000	3 1/4	1	10301-70-16	16.00
10	3.00	1,000	3 1/4	1 1/4	10301-70-20	16.00
10	4.00	1,400	4 1/4	1 1/4	10401-70-20	33.00
10	4.00	1,400	4 1/4	1 1/2	10401-70-24	33.00
12	2.50	900	3 1/4	1	12251-70-16	15.50
12	2.50	900	3 1/4	1 1/4	12251-70-20	15.50
12	3.00	1,125	3 1/4	1	12301-70-16	21.00
12	3.00	1,125	3 1/4	1 1/4	12301-70-20	21.00
12	4.00	1,600	4 1/4	1 1/4	12401-70-20	30.00
12	4.00	1,600	4 1/4	1 1/2	12401-70-24	30.00
16	4.00	1,450	4 1/4	1 1/4	16401-70-20	40.00
16	4.00	1,450	4 1/4	1 1/2	16401-70-24	40.00
16	5.00	1,500	5 1/4	1 1/4	16501-70-20	72.00
16	5.00	1,500	5 1/4	1 1/2	16501-70-24	72.00
18	5.00	2,800	5 1/4	1 1/4	18501-70-20	90.00
18	5.00	2,800	5 1/4	1 1/2	18501-70-24	90.00
18	5.00	2,800	5 1/4	2	18501-70-32	90.00
20	5.00	3,000	5 1/4	1 1/4	20501-70-20	100.00
20	5.00	3,000	5 1/4	1 1/2	20501-70-24	100.00
20	5.00	3,000	5 1/4	2	20501-70-32	100.00

CONTINUED

All dimensions are in inches. All weights are in pounds.

WHEELS MOLD ON RUBBER

PRECISION TAPERED BEARING

Diameter	Width	Capacity	Hub Length	Bore	Part Number	Weight
6	2.50	550	3 1/2	3/4	06259-70-12	6.50
6	2.50	550	3 1/2	1	06259-70-16	6.50
6	3.00	700	3 1/2	3/4	06309-70-12	9.50
6	3.00	700	3 1/2	1	06309-70-16	9.50
8	2.50	700	3 1/2	3/4	08259-70-12	9.50
8	3.00	850	3 1/2	3/4	08309-70-12	12.50
8	3.00	850	3 1/2	1	08309-70-16	12.50
8	3.00	850	3 1/2	1 1/4	08309-70-20	12.50
10	2.50	800	3 1/2	3/4	10259-70-12	13.00
10	2.50	800	3 1/2	1	10259-70-16	13.00
10	3.00	1,000	3 1/2	3/4	10309-70-12	16.00
10	3.00	1,000	3 1/2	1	10309-70-16	16.00
10	4.00	1,400	4 1/2	1	10409-70-16	33.00
10	4.00	1,400	4 1/2	1 1/4	10409-70-20	33.00
12	2.50	900	3 1/2	3/4	12259-70-12	15.50
12	2.50	900	3 1/2	1	12259-70-16	15.50
12	3.00	1,150	3 1/2	3/4	12309-70-12	21.00
12	3.00	1,150	3 1/2	1	12309-70-16	21.00
12	4.00	1,600	4 1/2	1	12409-70-16	30.00
12	4.00	1,600	4 1/2	1 1/4	12409-70-20	30.00
16	4.00	1,450	4 1/2	1	16409-70-16	40.00
16	4.00	1,450	4 1/2	1 1/4	16409-70-20	40.00
16	5.00	1,500	5 1/2	1	16509-70-16	72.00
16	5.00	1,500	5 1/2	1 1/4	16509-70-20	72.00
18	5.00	2,800	5 1/2	1	18509-70-16	90.00
18	5.00	2,800	5 1/2	1 1/4	18509-70-20	90.00
18	5.00	2,800	5 1/2	1 1/2	18509-70-24	90.00
20	5.00	3,000	5 1/2	1	20509-70-16	100.00
20	5.00	3,000	5 1/2	1 1/4	20509-70-20	100.00
20	5.00	3,000	5 1/2	1 1/2	20509-70-24	100.00

CONTINUED

WHEELS MOLD ON RUBBER

BEARINGLESS

Diameter	Width	Capacity	Hub Length	Bore	Part Number	Weight
5	2.00	400	2 3/16	1 3/16	05200-70-19	2.50
6	2.00	425	2 3/16	1 3/16	06200-70-19	4.50
6	2.50	550	3 1/4	1 15/16	06250-70-31	6.50
6	3.00	700	3 1/4	1 15/16	06300-70-31	9.50
8	2.00	500	2 3/16	1 3/16	08200-70-19	7.00
8	2.50	700	3 1/4	1 15/16	08250-70-31	9.50
8	3.00	850	3 1/4	1 15/16	08300-70-31	12.50
10	2.50	800	3 1/4	1 15/16	10250-70-31	13.00
10	3.00	1,000	3 1/4	1 15/16	10300-70-31	16.00
10	4.00	1,400	4 1/4	2 7/16	10400-70-39	33.00
12	2.50	900	3 1/4	1 15/16	12250-70-31	15.50
12	3.00	1,125	3 1/4	1 15/16	12300-70-31	21.00
12	4.00	1,600	4 1/4	2 7/16	12400-70-39	30.00
16	4.00	1,450	4 1/4	2 7/16	16400-70-39	40.00
16	5.00	1,500	5 1/4	2 7/16	16500-70-39	72.00
18	5.00	2,800	5 1/4	2 7/16	18500-70-39	90.00
18	5.00	2,800	5 1/4	3 1/4	18500-70-50	90.00
20	5.00	3,000	5 1/4	2 7/16	20500-70-39	100.00
20	5.00	3,000	5 1/4	3 1/4	20500-70-50	100.00

All dimensions are in inches. All weights are in pounds.

PARTS & ACCESSORIES

STRAIGHT ROLLER BEARINGS

Part Number	Inner Diameter	Outer Diameter	Length
SB081239	1/2	3/4	2-7/16 WITH OIL HOLE
SB081248	1/2	3/4	3
SB081264	1/2	3/4	4
SB121656	3/4	1	3-1/2
SB121658	3/4	1	3-9/16 WITH OIL HOLE
SB121648	3/4	1	3
SB162057	1	1-1/4	3-9/16
SB162073	1	1-1/4	4-9/16
SB162089	1	1-1/4	5-9/16
SB202457	1-1/4	1-1/2	3-9/16
SB202473	1-1/4	1-1/2	4-9/16
SB202489	1-1/4	1-1/2	5-9/16

TAPERED BEARINGS

Part Number	Inner Diameter	Outer Diameter
TB123102	3/4	1.93
TB122802	3/4	1.78
TB163202	1	1.98
TB163902	1	2.44
TB203702	1-1/4	2.32
TB203902	1-1/4	2.44
TB205002	1-1/4	3.12
TB245002	1-1/2	3.12

SPANNER BUSHINGS

Part Number	Inner Diameter	Outer Diameter	Length
SB081239	1/2	3/4	2-7/16 WITH OIL HOLE
SB081248	1/2	3/4	3
SB081264	1/2	3/4	4
SB121656	3/4	1	3-1/2
SB121658	3/4	1	3-9/16 WITH OIL HOLE
SB121648	3/4	1	3
SB162057	1	1-1/4	3-9/16
SB162073	1	1-1/4	4-9/16
SB162089	1	1-1/4	5-9/16
SB202457	1-1/4	1-1/2	3-9/16
SB202473	1-1/4	1-1/2	4-9/16
SB202489	1-1/4	1-1/2	5-9/16

REPLACEMENT AXLES

Part Number	Outer Diameter	Length	Description
AX085403	1/2	3-3/8	HOLLOW C/W L. NUT
AX085401	1/2	3-3/8	SOLID C/W LOCK NUT
AX127603	3/4	4-3/4	HOLLOW C/W L. NUT
AX127601	3/4	4-3/4	SOLID C/W LOCK NUT
AX168001	1	5	SOLID C/W LOCK NUT
AX168003	1	5	HOLLOW C/W L. NUT
AX169601	1	6	SOLID C/W LOCK NUT
AX169603	1	6	HOLLOW C/W L. NUT
AX208801	1-1/4	5-1/2	SOLID C/W LOCK NUT
AX201041	1-1/4	6-1-2	SOLID C/W LOCK NUT

AXLES

AX 20 152 02 (C)*

DIAMETER IN 1/16"

LENGTH IN 1/16" (IF NEEDED 3 PLACES)

TYPE

- | | |
|--------------------------------|---------------------------------|
| 00 SOLID | 06 SOLID w/ FLEXLOC |
| 01 SOLID w/ LOCK NUT | 07 HOLLOW w/ FLEXLOC |
| 02 HOLLOW | 08 SOLID w/ SLOTTED NUT |
| 03 HOLLOW w/ LOCK NUT | 09 HOLLOW w/ SLOTTED NUT |
| 04 DUAL END HOLLOW AXLE | |

COARSE THREAD "(C)"

- | | |
|---------------------|----------------------|
| 08 = 1/2-13 | 08 = 1/2-20 |
| 12 = 3/4-10 | 12 = 3/4-16 |
| 16 = 1-8 | 16 = 1-14 |
| 20 = 1-1/4-7 | 20 = 1-1/4-12 |

FINE THREAD

TERMS & CONDITIONS

WARRANTY

Caster Concepts, Inc. warrants its products to be free from defects in material or workmanship for the period of one year after the date of shipment from our factory. Warranty does not apply in cases of overloading, misapplication, abuse, normal wear and tear, damage in transit or in applications and operating conditions which we were not made aware of in advance. Caster Concepts' liability shall be limited to the replacement cost of the caster or wheel. Caster Concepts will not assume liability for incidental damage from use of its products. This warranty is void if our products are modified by others. No other warranty expressed or implied is made.

RETURNS AND ADJUSTMENTS

All returned goods must be authorized in writing in advance of shipment. Goods are to be returned freight prepaid. All goods must be in new and unused condition, and be standard stocking items. A handling charge will be assessed depending on the cost of reconditioning and restocking the product. Any claims for correction of product or adjustments must be filed with in five days of receipt of order. Custom built or modified products are not subject to return

TERMS AND CONDITIONS

Special or custom manufactured products are not subject to cancellation or return once the work has been started on the order. Our terms are net 30 days to customers with approved credit. Freight is shipped F.O.B. shipping point.

PRODUCT CHANGES

As Caster Concepts is constantly improving its products and methods of manufacturing, we reserve the right to modify and/or change our specifications of the products in this catalog without notice. However, we will attempt to keep our active distributors aware of any changes.



Can't Find What You Need? **ASK US!**

Our engineering team is second to none, they have conquered challenges that many companies wouldn't even face, and they have cleaned up the messes that many companies have made. We're no strangers to complex problems, whether its weight capacity, environment, custom fabrication, ergonomics or anything else related to material handling, we can help.



CASTER CONCEPTS

Beyond Standard.

16000 W. Michigan Ave., Albion, MI 49224

Tel: (517).680.4213 | Fax: (517).629.0082 | www.CasterConcepts.com

VERSION: 17.0