



Proud Manufacturer
of NSF Listed Products



YOUR PREMIER FOOD SERVICE SUPPLIER

FOOD SERVICE CASTER CATALOG 2019

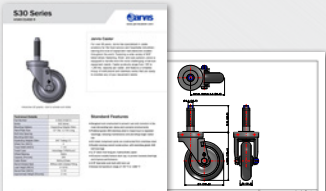

**3D CAD MODELS
& DATASHEETS
AVAILABLE ONLINE**

Visit www.JarvisCaster.com for details.



www.bandcip.com



For over 80 years, Jarvis has specialized in caster solutions for the food service and hospitality industries, earning the trust of equipment manufacturers around the world. Featuring a wide variety of NSF-listed wheel, fastening, finish, and size options, Jarvis is equipped to handle even the most challenging of service equipment needs.

APPLICATION SOLUTIONS BY JARVIS

LET US SOLVE YOUR CUSTOM APPLICATIONS NEEDS



Extra-large, double spring ring square stem



Dual spring ring stem caster is used to connect two mobile racks together



Adjustable load height stem caster especially designed for food service equipment



Easy-to-reach, foot-operated direction lock for straight tracking



Height-adjustable caster for grills



Caster with brake and combination top plate and adjustable stem



Caster for wire shelving



Height-adjustable caster for fryers



“Waffle” design rigid fork allows for multiple wheel positions

START A CONVERSATION WITH US AT www.bandcip.com TODAY!

30 Series Top Plate 36 Series Threaded Stem

CAPACITY UP TO 325 LBS EACH

FEATURES:

- Bright zinc-plated finish
- Hardened double ball raceways
- 1/2" diameter kingpin
- Dust cover protects swivel bearings
- Standard 3/8" diameter axle with locknut

OPTIONS:

- VertiLoc® brake; add **VL** to end of number
- PosiLoc® brake; add **PL** to end of number



5-30-213P PLT 2

5-36-213GD STEM 2

Top Plate Sizes (swivel & rigid): To order, add Plate Mounting Code to end of model number (Example: 5-30-105 **PLT 2**).

30 Series Mounting Code (Inches)	Top Plate Size (Inches)	Bolt Hole Spacing (Inches)	Bolt Size (Inches)
PLT 2	2-3/8 x 3-5/8	1-3/4 x 3	5/16
PLT 3	3-1/8 x 4-1/8	2-3/8 x 3-7/16	5/16

Threaded Stem sizes: To order, add Stem Mounting Code to end of model number (Example: 5-36-105 **STEM 2**).

36 Series Threaded Stem:

Mounting Code Number	Stem Size
STEM 2	1/2"-13 x 1"
STEM 3	1/2"-13 x 1-1/2"
STEM 6	5/8"-11 x 1-1/4"

Wheel Diameter (Inches)	Tread Width (Inches)	Wheel Type	Bearing	Capacity (Pounds)	Swivel Plate Model Number 30 Series	Threaded Stem Model Number 36 Series	Approximate Weight (Pounds)	Load Height (Plate)	Load Height (Threaded)	Swivel Radius (Inches)	
2 1/2	1 1/4	Cushion/Solid Rubber	Delrin	140	2-1/2-30-105	2-1/2-36-105	1-11/16	3 5/8	3 7/16	2 3/4	
		Hard/Solid Rubber	Delrin	210	2-1/2-30-106	2-1/2-36-106	1-11/16				
		Polyolefin	Plain	210	2-1/2-30-513	2-1/2-36-513	1-11/16				
3	1 1/4	Cushion/Solid Rubber	Delrin	150	3-30-105	3-36-105	1-3/4	4 1/8	3 15/16	3	
	1 1/2	Hard/Solid Rubber	Delrin	220	3-30-106	3-36-106	1-3/4				
		Polyolefin	Plain	250	3-30-521	3-36-521	1-3/4				
3 1/2	1 1/4	Cushion/Solid Rubber	Delrin	160	3-1/2-30-105	3-1/2-36-105	2	4 5/8	4 7/16	3 1/4	
		Advantage Heat Flat*	SS Ball	225	3-1/2-30-213RTF	3-1/2-36-213RTF	2-3/16				
		Advantage Health	SS Ball	225	3-1/2-30-213MF	3-1/2-36-213MF	2-3/16				
		Hard/Solid Rubber	Delrin	230	3-1/2-30-106	3-1/2-36-106	2				
		Polyolefin	Plain	250	3-1/2-30-513	3-1/2-36-513	2-3/16				
		Advantage TPR/Flat*	Ball	250	3-1/2-30-213GF	3-1/2-36-213GF	2-3/16				
		Polyloc/Blue	Ball	250	3-1/2-30-213P	3-1/2-36-213P	2-3/16				
		Polyloc/Grey	Delrin	250	3-1/2-30-314G	3-1/2-36-314G	2-3/16				
		Polyolefin	Plain	275	4-30-105	4-36-105	2-3/8				5 1/8
Advantage Heat Flat*	Delrin	250	4-30-106	4-36-106	2-3/8						
Advantage Health	SS Ball	250	4-30-213RTF	4-36-213RTF	2-1/2						
Polyloc/Blue	SS Ball	250	4-30-213MF	4-36-213MF	2-1/2						
Polyloc/Grey	Ball	275	4-30-213P	4-36-213P	2-1/2						
Polyolefin	Delrin	275	4-30-314G	4-36-314G	2-1/2						
Advantage TPR/Flat*	Plain	275	4-30-513	4-36-513	2-1/2						
	Ball	300	4-30-213GF	4-36-213GF	2-1/2						
	Phenolic	Plain	300	4-30-121	4-36-121	2-1/2					
5	1 1/4	Cushion/Solid Rubber	Delrin	200	5-30-105	5-36-105	2-3/4	6 1/4	6 1/16	4	
		Advantage Heat Flat*	SS Ball	250	5-30-213RTF	5-36-213RTF	3				
		Advantage Health	SS Ball	250	5-30-213MF	5-36-213MF	3				
		Hard/Solid Rubber	Delrin	280	5-30-106	5-36-106	2-3/4				
		Polyloc/Blue	Ball	300	5-30-213P	5-36-213P	3				
		Polyloc/Grey	Delrin	300	5-30-314G	5-36-314G	3				
		Polyolefin	Plain	300	5-30-513	5-36-513	3				
		Advantage TPR/Flat*	Ball	325	5-30-213GF	5-36-213GF	3				
			Phenolic	Plain	300	5-30-121	5-36-121				3
	6	1 1/4	Cushion/Solid Rubber	Delrin	220	6-30-105	6-36-105				3-1/8
Advantage TPR/Round			Ball	300	6-30-213GD	6-36-213GD	3-3/4				
Polyloc/Grey			Delrin	300	6-30-314G	6-36-314G	3-3/4				
Polyloc/Blue			Ball	300	6-30-213P	6-36-213P	3-3/4				
Advantage Heat Flat			SS Ball	325	6-30-213RTF	6-36-213RTF	3-3/4				
Advantage Health			SS Ball	325	6-30-213MF	6-36-213MF	3-3/4				
			Polyolefin	Plain	300	6-30-521	6-36-521	3-3/4			
			Phenolic	Plain	300	6-30-121	6-36-121	3-3/4			

*Round tread wheels available for Advantage TPR and Advantage Heat. Consult factory for temperature range and weight capacity on Advantage Heat wheels.

To order use wheel code: Advantage TPR=213GD, Advantage Heat=213RTR.

To order rigid top plate caster change 30 to 31 mounting code (Example 2-1/2-**31**-105 PLT 2).

WHEEL SELECTION:



Listed by NSF International

34/40 Series Stems

CAPACITY UP TO 325 LBS EACH

FEATURES:

- Bright zinc-plated finish
- Hardened double ball bearing swivel raceways
- 1/2"-diameter kingpin
- Dust cover protects swivel bearings
- Standard 3/8"-diameter axle with locknut

OPTIONS:

- VertiLoc® brake; add **VL** to end of number
- PosiLoc® brake; add **PL** to end of number



5-40-314G 19A

5-34-213GD STEM 3

Mounting Code	Stem Size
STEM 3	.845 dia. x 2-3/16"
STEM 4	.865 dia. x 2-3/16"

Mounting Code	Stem Size
STEM 6	.860 sq. x 2-3/16"
STEM 7	.875 sq. x 2-1/2" w/ 2 holes



Adapter Kit Parts

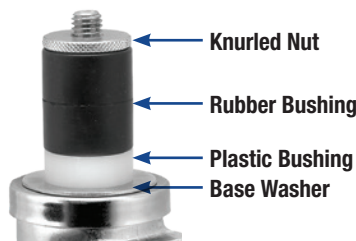

Rubber Expanding Adapters

Adapter Number	ID of Round or Square Tube (Inches)	Tube Size Range (Inches)
9	3/4	0.720-0.851
11*	7/8	0.852-0.927
13	1	0.928-1.029
15	1-1/8	1.030-1.140
17B	1-3/16	1.178-1.303
19C*	1-3/8	1.360-1.425
19A	1-1/2	1.426-1.589
21	1-7/8	1.790-1.850

*Stainless steel knurled nut and base washer.

Wheel Diameter (Inches)	Tread Width (Inches)	Wheel Type	Bearing	Capacity (Pounds)	Spring Ring Model Number 34 Series	Expanding Adapter Model 40 Series	Approximate Weight (Pounds)	Load Height (Plate)	Load Height (Threaded)
3 1/2	1 1/4	Cushion/Solid Rubber	Delrin	160	3-1/2-34-105	3-1/2-40-105	2	4 7/16	3 1/4
		Advantage Heat Flat*	SS Ball	225	3-1/2-34-213RTF	3-1/2-40-213RTF	2-3/16		
		Advantage Health	SS Ball	225	3-1/2-34-213MF	3-1/2-40-213MF	2-3/16		
		Hard/Solid Rubber	Delrin	230	3-1/2-34-106	3-1/2-40-106	2		
		Polyolefin	Plain	250	3-1/2-34-513	3-1/2-40-513	2-3/16		
		Advantage TPR/Flat*	Ball	250	3-1/2-34-213GF	3-1/2-40-213GF	2-3/16		
		Polyloc/Blue	Ball	250	3-1/2-34-213P	3-1/2-40-213P	2-3/16		
		Polyloc/Grey	Delrin	250	3-1/2-34-314G	3-1/2-40-314G	2-3/16		
4	1 1/4	Cushion/Solid Rubber	Delrin	170	4-34-105	4-40-105	2-3/8	4 15/16	3 1/2
		Hard/Solid Rubber	Delrin	250	4-34-106	4-40-106	2-3/8		
		Advantage Heat Flat*	SS Ball	250	4-34-213RTF	4-40-213RTF	2-1/2		
		Advantage Health	SS Ball	250	4-34-213MF	4-40-213MF	2-1/2		
		Polyloc/Blue	Ball	275	4-34-213P	4-40-213P	2-1/2		
		Polyloc/Grey	Delrin	275	4-34-314G	4-40-314G	2-1/2		
		Polyolefin	Plain	275	4-34-513	4-40-513	2-1/2		
	Advantage TPR/Flat*	Ball	300	4-34-213GF	4-40-213GF	2-1/2			
1 1/2	Phenolic	Plain	300	4-34-121	4-40-121	2-1/2			
5	1 1/4	Cushion/Solid Rubber	Delrin	200	5-34-105	5-40-105	2-3/4	6 1/16	4
		Advantage Heat Flat*	SS Ball	250	5-34-213RTF	5-40-213RTF	3		
		Advantage Health	SS Ball	250	5-34-213MF	5-40-213MF	3		
		Hard/Solid Rubber	Delrin	280	5-34-106	5-40-106	2-3/4		
		Polyloc/Blue	Ball	300	5-34-213P	5-40-213P	3		
		Polyloc/Grey	Delrin	300	5-34-314G	5-40-314G	3		
		Polyolefin	Plain	300	5-34-513	5-40-513	3		
		Advantage TPR/Flat*	Ball	325	5-34-213GF	5-40-213GF	3		
		1 1/2	Phenolic	Plain	300	5-34-121	5-40-121		

*Round tread wheels available for Advantage TPR and Advantage Heat. Consult factory for temperature range and weight capacity on Advantage Heat wheels.

To order use wheel code: Advantage TPR=213GD, Advantage Heat=213RTR.

To order add mounting code (Example 3-1/2-34-105-STEM3).

WHEEL SELECTION:



Listed by NSF International

Regent Series Threaded Stem and Expanding Adapter

CAPACITY UP TO 150 LBS EACH

FEATURES:

- USA-made
- High-strength & heat-treated steel construction for durability and increased caster life
- Double ball bearing raceways

OPTIONS:

- Brake available on all sizes; add **B** to end of model number (See Brake photos below)

Expanding Adapter Options:

Threaded Stem Options:

Mounting Code	Stem Size
605	3/8"-16 x 1-1/2"
748	1/2"-13 x 1-1/2"

Tubing		Tubing	
Mounting Code	I.D. Size	Mounting Code	I.D. Size
440	3/4"	444	1-1/4"
441	7/8"	445	1-3/8"
442	1"	446	1-1/2"
443	1-1/8"	446	1-5/8"

*To Order, insert blue Mounting Code into model number below.

Example: PRE50748ZN-TPR



PRE50748ZN-TPR

PRE40441ZN-3E

Wheel Diameter (Inches)	Tread Width (Inches)	Wheel Type	Bearing	Capacity (Pounds)	Regent Series Threaded Stem and Expanding Adapter*	Approximate Weight (Pounds)	Load Height (Inches)	Swivel Radius (Inches)
3	13/16	Cushion/Solid Rubber	Delrin	110	PRE30 __ ZN-3R	1 1/8	3 1/2	2 1/2
		TPR Tread/Poly Core	Plain	110	PRE30 __ ZN-TPR			
		Hard/Solid Rubber	Delrin	120	PRE30 __ ZN-3H			
		Polyolefin	Plain	120	PRE30 __ ZN-3E			
4	15/16	Cushion/Solid Rubber	Delrin	115	PRE40 __ ZN-3R	1 1/2	4 3/4	3 7/16
		TPR Tread/Poly Core	Plain	125	PRE40 __ ZN-TPR			
		Hard/Solid Rubber	Delrin	140	PRE40 __ ZN-3H			
		Polyolefin	Plain	150	PRE40 __ ZN-3E			
		PolyLoc/Grey	Plain	150	PRE40 __ ZN-TPU			
5	15/16	Cushion/Solid Rubber	Delrin	125	PRE50 __ ZN-3R	1 7/8	5 3/4	4 1/8
		TPR Tread/ Poly Core	Plain	150	PRE50 __ ZN-TPR			
		Hard/Solid Rubber	Delrin	150	PRE50 __ ZN-3H			
		Polyolefin	Plain	150	PRE50 __ ZN-3E			
		PolyLoc/Grey	Plain	160	PRE50 __ ZN-TPU			

Regent Series Top Plate

CAPACITY UP TO 150 LBS EACH

Standard Top Plate

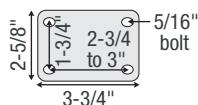

PRE30120ZN-3EB

PRI40120ZN-TPU

Wheel Diameter (Inches)	Tread Width (Inches)	Wheel Type	Bearing	Capacity (Pounds)	Regent Series Swivel Top Plate	Regent Series Rigid Top Plate	Load Height (Inches)	Swivel Radius (Inches)
3	15/16	Cushion/Solid Rubber	Delrin	110	PRE30120ZN-3R	PRI30120ZN-3R	3 1/2	2 1/2
		TPR Tread/Poly Core	Plain	110	PRE30120ZN-TPR	PRI30120ZN-TPR		
		Hard/Solid Rubber	Delrin	120	PRE30120ZN-3H	PRI30120ZN-3H		
		Polyolefin	Plain	120	PRE30120ZN-3E	PRI30120ZN-3E		
4	15/16	Cushion/Solid Rubber	Delrin	125	PRE40120ZN-3R	PRI40120ZN-3R	4 7/8	3 7/16
		TPR Tread/Poly Core	Plain	125	PRE40120ZN-TPR	PRI40120ZN-TPR		
		Hard/Solid Rubber	Delrin	150	PRE40120ZN-3H	PRI40120ZN-3H		
		Polyolefin	Plain	150	PRE40120ZN-3E	PRI40120ZN-3E		
		PolyLoc/Grey	Plain	150	PRE40120ZN-TPU	PRI40120ZN-TPU		
5	15/16	Cushion/Solid Rubber	Delrin	130	PRE50120ZN-3R	PRI50120ZN-3R	5 7/8	4 1/8
		TPR Tread/ Poly Core	Plain	130	PRE50120ZN-TPR	PRI50120ZN-TPR		
		Hard/Solid Rubber	Delrin	150	PRE50120ZN-3H	PRI50120ZN-3H		
		Polyolefin	Plain	150	PRE50120ZN-3E	PRI50120ZN-3E		
		PolyLoc/Grey	Plain	150	PRE50120ZN-TPU	PRI50120ZN-TPU		

WHEEL SELECTION:



CUSHION & HARD/
SOLID RUBBER



TPR TREAD/
POLY CORE



POLYOLEFIN



POLYLOC/GREY

BRAKES:



SIDE BRAKE
3" MODELS ONLY



TREAD LOCK
4" AND 5"
MODELS



Listed by NSF
International

36 Series Adjustable Load Height Casters



4-36-513 SATP PLT 2

CAPACITY UP TO 325 LBS EACH

FEATURES:

- Special caster has adjustable load height of 7 3/4" to 9 1/4"
- Height adjustment is achieved by turning the stem until the desired height is reached, then stem locks in place with a set screw
- Bright zinc-plated finish
- Hardened double ball bearing swivel raceways
- 1/2"-diameter kingpin
- Dust cover protects swivel bearings
- Standard 3/8"-diameter axle with locknut

OPTIONS:

- VertiLoc® brake; add **VL** to end of number
- PosiLoc® brake; add **PL** to end of number

To order, add Mounting Code to end of model number (Example 3-36-521-SATP PLT 2).

Mounting Code	Top Plate Size (Inches)	Bolt Hole Spacing (Inches)	Mounting Bolt Size (Inches)
PLT 2	2-3/8 x 3-5/8	1-3/4 x 3	5/16
PLT 7	3-1/2 x 3-1/2	2-5/8 x 2-5/8 to 3 x 3	9/32

Special food service caster has adjustable load height of 7 3/4" to 9 1/4". Height adjustment is achieved by turning the stem until the desired height is reached. Stem locks in place with a set screw.

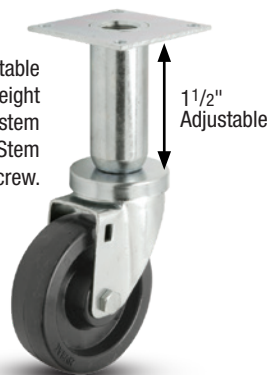

Wheel Diameter (Inches)	Tread Width (Inches)	Wheel Type	Bearing	Capacity (Pounds)	Adjustable Height Model 36 Series	Approximate Weight (Pounds)	Load Height (Plate)	Swivel Radius (Inches)
3	1 1/4	Polyolefin	Plain	250	3-36-521 SATP	2-1/2	Adjustable	3
4	1 1/4	Polyolefin	Plain	275	4-36-513 SATP	2-3/8	Adjustable	3 1/2
5	1 1/4	Polyolefin	Plain	300	5-36-513 SATP	2-3/4	Adjustable	4

Add mounting code (Example 3-36-521-SATP PLT 2).

WHEEL SELECTION:

Standard stocking wheel is polyolefin. These wheels also available as special order – consult factory.



S30 Series Stainless Steel Top Plate

CAPACITY UP TO 325 LBS EACH

FEATURES:

- Polished 304 stainless steel finish
- Double ball bearing swivel raceways
- Grease sealed raceways with zerk
- 1/2"-diameter kingpin
- Stainless steel 3/8"-diameter axle with locknut

OPTIONS:

- Black and white polyolefin wheels available; for white polyolefin wheels add WH after 513 (Example: 5-S30-513WH)
- VertiLoc® brake; add **VL** to end of number
- PosiLoc® brake; add **PL** to end of number



S30/31 Top Plate Sizes (swivel & rigid): To order, add Mounting Code to end of model number (Example: 5-30-314 **PLT 2**).

Mounting Code	Top Plate Size (Inches)	Bolt Hole Spacing (Inches)	Mounting Bolt Size (Inches)
PLT 2	2-3/8 x 3-5/8	1-3/4 x 3	5/16



Wheel Diameter (Inches)	Tread Width (Inches)	Wheel Type	Bearing	Capacity (Pounds)	Swivel Caster Model Number S30 Series	Rigid Caster Model Number S31 Series	Approximate Weight (Pounds)	Load Height (Plate)	Swivel Radius (Inches)
4	1 1/4	Advantage TPR/Round	Delrin	250	4-S30-314GD	4-S31-314GD	2 1/4	5 1/16	3 1/2
		Advantage TPR/Flat	Delrin	300	4-S30-314GF	4-S31-314GF			
		Polyolefin	SS Sleeve	300	4-S30-513	4-S31-513			
		PolyLoc/Grey	Delrin	300	4-S30-314G	4-S31-314G			
		Advantage Heat Flat*	SS Ball	300	4-S30-213RTF	4-S31-213RTF			
		Advantage Health	SS Ball	300	4-S30-213MF	4-S31-213MF			
	1 1/2	Phenolic	SS Sleeve	300	4-S30-121	4-S31-121			
		Hi-Temp Resin	Plain	300	4-S30-521HT	4-S31-121HT			
5	1 1/4	Advantage TPR/Round†	SS Ball	250	5-S30-213GD	5-S31-213GD	2 3/4	6 1/8	4
		Polyolefin	SS Sleeve	300	5-S30-513	5-S31-513			
		Welded Disc/Polyurethane	SS Sleeve	300	5-S30-113P	5-S31-113P			
		PolyLoc/Grey†	SS Ball	300	5-S30-213G	5-S31-213G			
		Advantage Heat Flat*	SS Ball	300	5-S30-213RTF	5-S31-213RTF			
		Advantage Health	SS Ball	300	5-S30-213MF	5-S31-213MF			
	1 1/2	Advantage TPR/Flat	Delrin	325	5-S30-213GF	5-S31-213GF			
		Phenolic	SS Sleeve	300	5-S30-121	5-S31-121			
		Hi-Temp Resin	Plain	325	5-S30-521NHT	5-S31-NHT			
6	1 1/4	Advantage TPR/Round	Delrin	300	6-S30-314GD	6-S31-314GD	3 1/4	7 3/16	4 1/2
		Polyolefin	SS Sleeve	300	6-S30-521	6-S31-521			
		PolyLoc/Grey*	SS Ball	300	6-S30-213G	6-S31-213G			
		Advantage Heat Flat	SS Ball	325	6-S30-213RTF	6-S31-213RTF			
	1 1/2	Advantage Health	SS Ball	325	6-S30-213MF	6-S31-213MF			
		Phenolic	SS Sleeve	300	6-S30-121	6-S31-121			

*Delrin bearing also available – consult factory.

†Advantage Heat round treads also available, change RTR to RTF.

WHEEL SELECTION:



CUSHION/
SOLID RUBBER



ADVANTAGE TPR/FLAT
AND ROUND



POLYOLEFIN



POLYLOC/
GREY



ADVANTAGE
HEAT FLAT
OR ROUND



ADVANTAGE
HEALTH
Antimicrobial



WELDED DISC/
POLYURETHANE

NSF

Listed by NSF
International

CAPACITY UP TO 325 LBS EACH



FEATURES:

- Polished 304 stainless steel finish
- Double ball bearing swivel raceways
- Grease sealed raceways with zerk
- 1/2"-diameter kingpin
- Stainless steel 3/8"-diameter axle with locknut

OPTIONS:

- Black or white polyolefin wheels available; for white polyolefin wheels add WH after 513 (Example: 5-S30-513WH)
- VertiLoc® brake; add VL to end of number
- PosiLoc® brake; add PL to end of number

Adapter Kit Parts

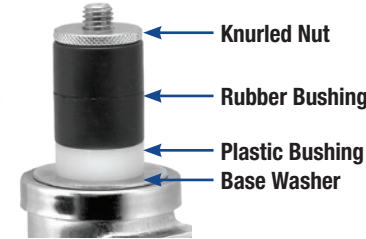

S34 Spring Ring standard size is .845" diameter x 2-3/16" long. No mounting code necessary.



S36 Threaded Stem standard size 1/2" diameter x 13 x 1-1/2" long. Other sizes available.

S40 Rubber Expanding Adapters

Adapter Number	ID of Round or Square Tube (Inches)	Tube Size Range (Inches)
9	3/4	0.720-0.851
11*	7/8	0.852-0.927
13	1	0.928-1.029
15	1-1/8	1.030-1.140
17B	1-3/16	1.178-1.303
19C*	1-3/8	1.360-1.425
19A	1-1/2	1.426-1.589
21	1-7/8	1.790-1.850

*Stainless steel knurled nut and base washer

Wheel Diameter (Inches)	Tread Width (Inches)	Wheel Type	Bearing	Capacity (Pounds)	Spring Ring Stem Model S34 Series	Threaded Stem Model S36 Series	Expanding Adapter Model S40 Series	Approximate Weight (Pounds)	Load Height (Inches)	Swivel Radius (Inches)
4	1 1/4	Advantage TPR/Round	Delrin	250	4-S34-314GD	4-S36-314GD	4-S40-314GD	2 1/4	4 15/16	3 1/2
		Advantage TPR/Flat	Delrin	300	4-S34-314GF	4-S36-314GF	4-S40-314GF			
		Polyolefin	SS Sleeve	300	4-S34-513	4-S36-513	4-S40-513			
		PolyLoc/Grey	Delrin	300	4-S34-314G	4-S36-314G	4-S40-314G			
		Advantage Heat Flat*	SS Ball	300	4-S34-213RTF	4-S36-213RTF	4-S40-213RTF			
		Advantage Health	SS Ball	300	4-S34-213MF	4-S36-213MF	4-S40-213MF			
	1 1/2	Phenolic	SS Sleeve	300	4-S34-121	4-S36-121	4-S40-121			
		Hi-Temp Resin	Plain	300	4-S34-521HT	4-S36-121HT	4-S40-121HT			
5	1 1/4	Advantage TPR/Round ¹	SS Ball	250	5-S34-213GD	5-S36-213GD	5-S40-213GD	2 3/4	6	4
		Polyolefin	SS Sleeve	300	5-S34-513	5-S36-513	5-S40-513			
		Welded Disc/Polyurethane	SS Sleeve	300	5-S34-113P	5-S36-113P	5-S40-113P			
		PolyLoc/Grey ¹	SS Ball	300	5-S34-213G	5-S36-213G	5-S40-213G			
		Advantage Heat Flat*	SS Ball	300	5-S34-213RTF	5-S36-213RTF	5-S40-213RTF			
		Advantage Health	SS Ball	300	5-S34-213MF	5-S36-213MF	5-S40-213MF			
		Advantage TPR/Flat	Delrin	325	5-S34-213GF	5-S36-213GF	5-S40-213GF			
	1 1/2	Phenolic	SS Sleeve	300	5-S34-121	5-S36-121	5-S40-121			
		Hi-Temp Resin	Plain	325	5-S34-521NHT	5-S36-NHT	5-S40-NHT			
6	1 1/4	Advantage TPR/Round	Delrin	300	6-S34-314GD	6-S36-314GD	6-S40-314GD	3 1/4	7 1/16	4 1/2
		Polyolefin	SS Sleeve	300	6-S34-521	6-S36-521	6-S40-521			
		PolyLoc/Grey*	SS Ball	300	6-S34-213G	6-S36-213G	6-S40-213G			
		Advantage Heat Flat	SS Ball	325	6-S34-213RTF	6-S36-213RTF	6-S40-213RTF			
		Advantage Health	SS Ball	325	6-S34-213MF	6-S36-213MF	6-S40-213MF			
	1 1/2	Phenolic	SS Sleeve	300	6-S34-121	6-S36-121	6-S40-121			

*Delrin bearing also available – consult factory.

¹Advantage Heat round treads also available, change RTR to RTF.

WHEEL SELECTION:



Listed by NSF International

130 Series Top Plate

CAPACITY UP TO 400 LBS EACH

FEATURES:

- Heavy gauge cold-rolled steel, formed for strength and heat-treated
- Dust Cap protects swivel raceway bearings and improves performance
- Bright zinc plating to resist rust and corrosion
- Swivel Construction: Double ball bearing with hardened raceways
- Wheel sizes 3", 4" and 5" use 3/8"-diameter axle
- Wheel sizes 6" and 8" use 1/2"-diameter axle
- King Pin: 1/2" steel rivet
- Fork Leg Spacing: 2"

OPTIONS:

- VertiLoc® brake; add **VL** to end of number
- Swivel Grease Seal: Includes zerk grease fitting in dust cap: To order, add **GS** to end of model number
- Optional Plate Sizes: Variety of plate sizes available – consult factory

130/131: Top Plate Sizes (swivel & rigid): To order, add Plate Mounting Code to end of model number. (Example: 5-130-522 **PLT 2**)

Mounting Code	Top Plate Size (Inches)	Bolt Hole Spacing (Inches)	Mounting Bolt Size (Inches)
PLT 2	2-3/8 x 3-5/8	1-3/4 x 3	5/16



5-131-215GF PLT 2

Wheel Diameter (Inches)	Tread Width (Inches)	Wheel Type	Bearing	Capacity (Pounds)	Swivel Caster Model Number 130 Series	Rigid Caster Model Number 131 Series	Approximate Weight (Pounds)	Load Height (Inches)	Swivel Radius (Inches)
3	1 13/16	Polyolefin	Roller	400	3-130-532	3-131-532	1-3/4	4	2 3/8
4	1 5/8	Cushion/Solid Rubber	Plain	225	4-130-109	4-131-109	2 1/8	5 3/8	3 1/2
		Cushion/Solid Rubber	Roller	225	4-130-209	4-131-209			
		Hard/Solid Rubber	Plain	400	4-130-110	4-131-110			
		Hard/Solid Rubber	Roller	400	4-130-210	4-131-210			
	1 1/2	Phenolic	Plain	400	4-130-121	4-131-121			
		Phenolic	Roller	400	4-130-221	4-131-221			
		Polyolefin	Plain	400	4-130-521	4-131-521			
		Polyolefin	Roller	400	4-130-522	4-131-522			
5	1 5/8	Cushion/Solid Rubber	Plain	260	5-130-109	5-131-109	2-3/4	6 1/4	4
		Cushion/Solid Rubber	Roller	260	5-130-209	5-131-209	2-3/4		
		Hard/Solid Rubber	Plain	400	5-130-110	5-131-110	2-1/2		
		Hard/Solid Rubber	Roller	400	5-130-210	5-131-210	2-1/2		
	1 1/2	Phenolic	Plain	400	5-130-121	5-131-121	2-1/2		
		Phenolic	Roller	400	5-130-221	5-131-221	2-1/2		
		Polyolefin	Plain	400	5-130-521	5-131-521	2-3/4		
		Polyolefin	Roller	400	5-130-522	5-131-522	2-3/4		
		Advantage TPR/Flat	Roller	400	5-130-215GF	5-131-215GF	2-1/8		
		PolyLoc/Grey	Roller	400	5-130-215G	5-131-215G	2-1/8		
PolyLoc/Blue	Roller	400	5-130-215P	5-131-215P	2-1/8				
6	1 1/2	Phenolic	Plain	400	6-130-121	6-131-121	2 3/4	7 1/2	4 3/4
		Phenolic	Roller	400	6-130-221	6-131-221			
		Polyolefin	Delrin	400	6-130-523	6-131-523			
		Polyolefin	Roller	400	6-130-522	6-131-522			
		Advantage TPR/Flat	Roller	400	6-130-215GF	6-131-215GF			
		PolyLoc/Grey	Roller	400	6-130-215G	6-131-215G			
		PolyLoc/Blue	Roller	400	6-130-215P	6-131-215P			
8	1 1/2	Advantage TPR/Flat	Roller	250	8-130-215GF	8-131-215GF	3	9 1/2	6 1/2
		PolyLoc/Grey	Roller	250	8-130-215G	8-131-215G			
		PolyLoc/Blue	Roller	250	8-130-215P	8-131-215P			
		Polyolefin	Delrin	250	8-130-523	8-131-523			
		Polyolefin	Roller	250	8-130-522	8-131-522			

WHEEL SELECTION:



CUSHION & HARD/SOLID RUBBER

ADVANTAGE TPR FLAT

PHENOLIC

POLYOLEFIN

POLYLOC/GREY

POLYLOC/BLUE



Listed by NSF International

134/136 Series Stems

CAPACITY UP TO 400 LBS EACH



5-134-215G STEM 1

5-136-215GF STEM 1

FEATURES:

- Heavy gauge cold-rolled steel, formed for strength and heat-treated
- Dust Cap protects swivel raceway bearings and improves performance
- Bright zinc plating to resist rust and corrosion
- Swivel Construction: Double ball bearing with hardened raceways
- Wheel sizes 3", 4" and 5" use 3/8"-diameter axle
- Wheel sizes 6" and 8" use 1/2"-diameter axle
- King Pin: 1/2" steel rivet
- Fork Leg Spacing: 2"

OPTIONS:

- VertiLoc® brake; add **VL** to end of number
- Swivel Grease Seal: Includes zerk grease fitting in dust cap: To order, add **GS** to end of model number
- Optional Plate Sizes: Variety of plate sizes available – consult factory

134 Series Spring Ring: To order, specify stem code number and add to end of caster model number (Example: 6-134-215G **STEM 1**).

STEM Code	STEM Sizes
STEM 1	3/4" diameter x 2-3/16" long
STEM 2	13/16" diameter x 2-3/16" long
STEM 3	.845" diameter x 2-3/16" long
STEM 4	.865" diameter x 2-3/16" long
STEM 5	1" diameter x 2-3/16" long
STEM 6	.860" SQUARE x 2-3/16" long

136 Threaded Stem: To order, specify stem code number and add to end of caster model number (Example: 6-136-215G **STEM 1**).

STEM Code	STEM Sizes
STEM 1	1/2" diameter – 13 x 3/4" long
STEM 2	1/2" diameter – 13 x 1" long
STEM 3	1/2" diameter – 13 x 1-1/2" long
STEM 4	1/2" diameter – 20 x 3/4" long
STEM 5	1/2" diameter – 20 x 2-1/4" long
STEM 6	5/8" diameter – 11 x 1-1/4" long
STEM 7	5/8" diameter – 18 x 1-3/4" long
STEM 8	3/4" diameter – 10 x 1" long

Wheel Diameter (Inches)	Tread Width (Inches)	Wheel Type	Bearing	Capacity (Pounds)	Spring Ring Stem Model Number 134 Series	Threaded Stem Model Number 136 Series	Approximate Weight (Pounds)	Load Height (Inches)	Swivel Radius (Inches)
3	1 13/16	Polyolefin	Roller	400	3-134-532	3-136-532	1 3/4	3 7/8	2 3/8
4	1 5/8	Cushion/Solid Rubber	Plain	225	4-134-109	4-136-109	2 1/8	5 3/16	3 1/2
		Cushion/Solid Rubber	Roller	225	4-134-209	4-136-209			
		Hard/Solid Rubber	Plain	400	4-134-110	4-136-110			
		Hard/Solid Rubber	Roller	400	4-134-210	4-136-210			
	1 1/2	Phenolic	Plain	400	4-134-121	4-136-121			
		Phenolic	Roller	400	4-134-221	4-136-221			
		Polyolefin	Plain	400	4-134-521	4-136-521			
		Polyolefin	Roller	400	4-134-522	4-136-522			
5	1 5/8	Cushion/Solid Rubber	Plain	260	5-134-109	5-136-109	2-3/4	6 1/16	4
		Cushion/Solid Rubber	Roller	260	5-134-209	5-136-209	2-3/4		
		Hard/Solid Rubber	Plain	400	5-134-110	5-136-110	2-1/2		
		Hard/Solid Rubber	Roller	400	5-134-210	5-136-210	2-1/2		
	1 1/2	Phenolic	Plain	400	5-134-121	5-136-121	2-1/2		
		Phenolic	Roller	400	5-134-221	5-136-221	2-1/2		
		Polyolefin	Plain	400	5-134-521	5-136-521	2-3/4		
		Polyolefin	Roller	400	5-134-522	5-136-522	2-3/4		
		Advantage TPR/Flat	Roller	400	5-134-215GF	5-136-215GF	2-1/8		
		PolyLoc/Grey	Roller	400	5-134-215G	5-136-215G	2-1/8		
PolyLoc/Blue	Roller	400	5-134-215P	5-136-215P	2-1/8				
6	1 1/2	Phenolic	Plain	400	6-134-121	6-136-121	2 3/4	7 5/16	4 3/4
		Phenolic	Roller	400	6-134-221	6-136-221			
		Polyolefin	Delrin	400	6-134-523	6-136-523			
		Polyolefin	Roller	400	6-134-522	6-136-522			
		Advantage TPR/Flat	Roller	400	6-134-215GF	6-136-215GF			
		PolyLoc/Grey	Roller	400	6-134-215G	6-136-215G			
		PolyLoc/Blue	Roller	400	6-134-215P	6-136-215P			
8	1 1/2	Advantage TPR/Flat	Roller	250	8-134-215GF	8-136-215GF	3	9 5/16	6 1/2
		PolyLoc/Grey	Roller	250	8-134-215G	8-136-215G			
		PolyLoc/Blue	Roller	250	8-134-215P	8-136-215P			
		Polyolefin	Delrin	250	8-134-523	8-136-523			
		Polyolefin	Roller	250	8-134-522	8-136-522			

WHEEL SELECTION:



CUSHION & HARD/SOLID RUBBER

ADVANTAGE TPR FLAT

PHENOLIC

POLYOLEFIN

POLYLOC GREY

POLYLOC BLUE

S81 & S82 Series Stainless Steel Top Plate

CAPACITY UP TO 1,250 LBS EACH

FEATURES:

- Polished 304 stainless steel finish
- Double ball bearing swivel raceways
- 5/8"-diameter kingpin
- Stainless steel 1/2"-diameter axle with locknut

OPTIONS:

- Black or white polyolefin wheels available; for white polyolefin wheels add **WH** after 531 (Example: 5-S81-531**WH**)
- Upper and lower raceway – consult factory
- VertiLoc™ HD brake; add **VL** to end of number

Top Plate Dimensions:

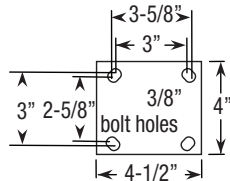

Wheel Diameter (Inches)	Tread Width (Inches)	Wheel Type	Bearing	Capacity (Pounds)	Swivel Caster Model Number S81 Series	Rigid Caster Model Number S82 Series	Approximate Weight (Pounds)	Load Height (Plate)	Swivel Radius (Inches)
5	2	Advantage Health	Delrin	375	5-S81-320MF	5-S82-320MF	5 1/2	6 1/2	4 5/16
		Polyolefin	Plain	650	5-S81-531	5-S82-531			
		Polyloc/Grey	Delrin	700	5-S81-320G	5-S82-320G			
		Phenolic	Delrin	1,000	5-S81-322	5-S82-322			
6	2	Advantage TPR/Round	Delrin	450	6-S81-320GD	6-S82-320GD	6 1/2	7 1/2	5 1/16
		Advantage Health	Delrin	600	6-S81-320MF	6-S82-320MF			
		Polyolefin	Plain	700	6-S81-531	6-S82-531			
		Polyloc/Grey	Delrin	800	6-S81-320G	6-S82-320G			
		Phenolic	Delrin	1,200	6-S81-322	6-S82-322			
8	2	Advantage TPR/Round	Delrin	450	8-S81-320GD	8-S82-320GD	8	9 1/2	6 1/2
		Advantage TPR/Flat	Delrin	675	8-S81-320GF	8-S82-320GF			
		Polyolefin	Plain	900	8-S81-531	8-S82-531			
		Polyloc/Grey	Delrin	1,000	8-S81-320G	8-S82-320G			
		Phenolic	Delrin	1,250	8-S81-322	8-S82-322			

S81/S82 WHEEL SELECTION:



Bumpers

End Bumper B-1



4714-00
(Grey)

4714-01
(Black)

Tube Bumper B-3-1/2



B-3-1/2 R
(Round Stem)

B-3-1/2 S
(Square Stem)

Rolling Bumper B-5



Corner Bumper B-8

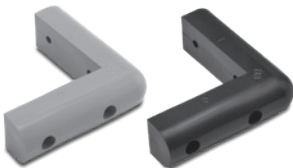

4718-00
(Grey)

4719-00
(Black)

Corner Bumper B-10



4720-01
(Grey)

4721-01
(Black)

Corner Bumper B-12



4722-01
(Grey)

4724-01
(Black)



Listed by NSF
International



YOUR PREMIER FOOD SERVICE SUPPLIER

FREE CAD MODELS & DATASHEETS EXPLORE • DOWNLOAD • SHARE

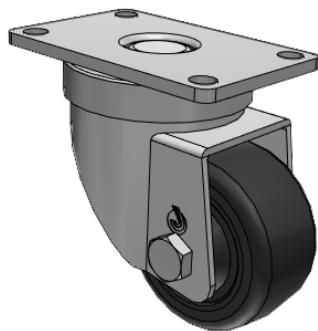

- Quickly **configure** models
- Download **native CAD formats**
- Download **datasheets**
- Easily **share** with your team

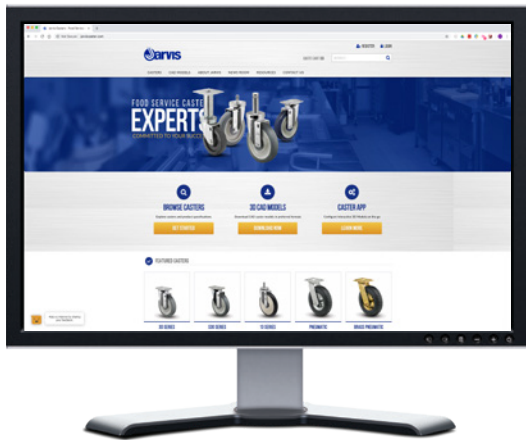
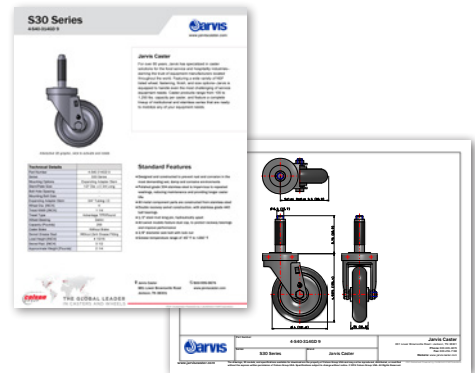

ONLINE
www.JarvisCaster.com



DOWNLOAD THE APP
Search: "Caster CAD 3D"



— A BRAND OF —
colson GROUP THE GLOBAL LEADER
IN CASTERS AND WHEELS

888-276-3386

www.bandcip.com